

SECTION **RF**  
ROOF

A  
B  
C  
D  
E  
F  
G  
H  
I  
J  
L  
M  
N  
O  
P

**CONTENTS**

**WITH SINGLE PANEL SUNROOF**

<b>BASIC INSPECTION</b> .....	4	SUNROOF MOTOR ASSEMBLY : Component Function Check .....	14
<b>DIAGNOSIS AND REPAIR WORKFLOW</b> .....	4	SUNROOF MOTOR ASSEMBLY : Diagnosis Procedure .....	14
Work Flow .....	4	SUNROOF MOTOR ASSEMBLY : Component In- spection .....	17
<b>INSPECTION AND ADJUSTMENT</b> .....	7	SUNROOF MOTOR ASSEMBLY : Special Repair Requirement .....	18
<b>ADDITIONAL SERVICE WHEN REPLACING CONTROL UNIT</b> .....	7	<b>DOOR SWITCH</b> .....	19
ADDITIONAL SERVICE WHEN REPLACING CONTROL UNIT : Description .....	7	Description .....	19
ADDITIONAL SERVICE WHEN REPLACING CONTROL UNIT : Special Repair Requirement .....	7	Component Function Check .....	19
<b>BASIC INSPECTION</b> .....	7	Diagnosis Procedure .....	19
BASIC INSPECTION : Special Repair Require- ment .....	7	Component Inspection .....	21
<b>FUNCTION DIAGNOSIS</b> .....	9	<b>ECU DIAGNOSIS</b> .....	22
<b>SUNROOF SYSTEM</b> .....	9	<b>BCM (BODY CONTROL MODULE)</b> .....	22
System Diagram .....	9	Reference Value .....	22
System Description .....	9	Terminal Layout .....	27
Component Parts Location .....	10	Physical Values .....	27
Component Description .....	10	Wiring Diagram .....	45
<b>DIAGNOSIS SYSTEM (BCM)</b> .....	12	Fail Safe .....	53
<b>COMMON ITEM</b> .....	12	DTC Inspection Priority Chart .....	55
COMMON ITEM : Diagnosis Description .....	12	DTC Index .....	57
COMMON ITEM : CONSULT-III Function .....	12	<b>SUNROOF SYSTEM</b> .....	59
<b>RETAINED PWR</b> .....	12	Reference Value .....	59
RETAINED PWR : CONSULT-III Function (BCM - RETAINED PWR) .....	13	Wiring Diagram .....	60
<b>COMPONENT DIAGNOSIS</b> .....	14	<b>SYMPTOM DIAGNOSIS</b> .....	66
<b>POWER SUPPLY AND GROUND CIRCUIT</b> .....	14	<b>SUNROOF DOES NOT OPERATE PROPER- LY</b> .....	66
<b>SUNROOF MOTOR ASSEMBLY</b> .....	14	Diagnosis Procedure .....	66
SUNROOF MOTOR ASSEMBLY : Description .....	14	<b>AUTO OPERATION DOES NOT OPERATE</b> ....	67
		Diagnosis Procedure .....	67
		<b>DOES NOT STOP FULLY-OPEN OR FULLY- CLOSED POSITION</b> .....	68
		Diagnosis Procedure .....	68

**RF**

<b>RETAINED POWER OPERATION DOES NOT OPERATE PROPERLY</b> .....	<b>69</b>	<b>COMMON ITEM</b> .....	<b>93</b>
Diagnosis Procedure .....	69	COMMON ITEM : Diagnosis Description .....	93
<b>SUNROOF DOES NOT OPERATE ANTI-PINCH FUNCTION</b> .....	<b>70</b>	COMMON ITEM : CONSULT-III Function .....	93
Diagnosis Procedure .....	70	<b>RETAINED PWR</b> .....	<b>93</b>
<b>SQUEAK AND RATTLE TROUBLE DIAGNOSES</b> .....	<b>71</b>	RETAINED PWR : CONSULT-III Function (BCM - RETAINED PWR) .....	94
Work Flow .....	71	<b>COMPONENT DIAGNOSIS</b> .....	<b>95</b>
Generic Squeak and Rattle Troubleshooting .....	73	<b>POWER SUPPLY AND GROUND CIRCUIT</b> ....	<b>95</b>
Diagnostic Worksheet .....	75	<b>BCM</b> .....	<b>95</b>
<b>PRECAUTION</b> .....	<b>77</b>	BCM : Diagnosis Procedure .....	95
<b>PRECAUTIONS</b> .....	<b>77</b>	<b>SUNROOF MOTOR ASSEMBLY</b> .....	<b>96</b>
Precaution for Supplemental Restraint System (SRS) "AIR BAG" and "SEAT BELT PRE-TENSIONER" .....	77	SUNROOF MOTOR ASSEMBLY : Diagnosis Procedure .....	96
Precautions .....	77	<b>SUNSHADE MOTOR ASSEMBLY</b> .....	<b>97</b>
Precautions Necessary for Steering Wheel Rotation after Battery Disconnect (Early Production, With Electronic Steering Column Lock) .....	77	SUNSHADE MOTOR ASSEMBLY : Diagnosis Procedure .....	97
<b>PREPARATION</b> .....	<b>79</b>	<b>COMMUNICATION SIGNAL CIRCUIT</b> .....	<b>99</b>
<b>PREPARATION</b> .....	<b>79</b>	Description .....	99
Special Service Tools .....	79	Diagnosis Procedure .....	99
Commercial Service Tools .....	79	<b>SUNROOF SWITCH</b> .....	<b>100</b>
<b>ON-VEHICLE REPAIR</b> .....	<b>80</b>	Description .....	100
<b>SUNROOF UNIT ASSEMBLY</b> .....	<b>80</b>	Diagnosis Procedure .....	100
Inspection .....	80	Component Inspection .....	101
Exploded View .....	84	<b>DOOR SWITCH</b> .....	<b>103</b>
Removal and Installation .....	84	Description .....	103
<b>WITH DUAL PANEL SUNROOF</b>		Component Function Check .....	103
<b>BASIC INSPECTION</b> .....	<b>87</b>	Diagnosis Procedure .....	103
<b>DIAGNOSIS AND REPAIR WORKFLOW</b> .....	<b>87</b>	Component Inspection .....	105
WorkFlow .....	87	<b>ECU DIAGNOSIS</b> .....	<b>106</b>
<b>INSPECTION AND ADJUSTMENT</b> .....	<b>88</b>	<b>BCM (BODY CONTROL MODULE)</b> .....	<b>106</b>
<b>ADDITIONAL SERVICE WHEN REPLACING CONTROL UNIT</b> .....	<b>88</b>	Reference Value .....	106
ADDITIONAL SERVICE WHEN REPLACING CONTROL UNIT : Description .....	88	Terminal Layout .....	111
ADDITIONAL SERVICE WHEN REPLACING CONTROL UNIT : Special Repair Requirement ....	88	Physical Values .....	111
<b>FUNCTION DIAGNOSIS</b> .....	<b>89</b>	Wiring Diagram .....	129
<b>SUNROOF SYSTEM</b> .....	<b>89</b>	Fail Safe .....	137
System Diagram .....	89	DTC Inspection Priority Chart .....	139
System Description .....	89	DTC Index .....	141
Component Parts Location .....	91	<b>SUNROOF MOTOR ASSEMBLY</b> .....	<b>143</b>
Component Description .....	92	Reference Value .....	143
<b>DIAGNOSIS SYSTEM (BCM)</b> .....	<b>93</b>	Wiring Diagram .....	145
		<b>SUNSHADE MOTOR ASSEMBLY</b> .....	<b>152</b>
		Reference Value .....	152
		Wiring Diagram .....	153
		<b>SYMPTOM DIAGNOSIS</b> .....	<b>160</b>
		<b>SUNROOF DOES NOT OPERATE PROPERLY</b> .....	<b>160</b>
		Diagnosis Procedure .....	160

<b>SUNSHADE SYSTEM DOES NOT OPERATE PROPERLY</b> .....	<b>161</b>	<b>ON-VEHICLE REPAIR</b> .....	<b>174</b>	A
Diagnosis Procedure .....	161	<b>GLASS LID</b> .....	<b>174</b>	
		Removal and Installation .....	174	B
<b>AUTO OPERATION DOES NOT OPERATE</b> ..	<b>162</b>	<b>SUNROOF MOTOR ASSEMBLY</b> .....	<b>176</b>	
Diagnosis Procedure .....	162	Removal and Installation .....	176	C
<b>RETAINED POWER OPERATION DOES NOT OPERATE PROPERLY</b> .....	<b>163</b>	<b>SUNSHADE MOTOR ASSEMBLY</b> .....	<b>177</b>	
Diagnosis Procedure .....	163	Removal and Installation .....	177	D
<b>ANTI-PINCH FUNCTION DOES NOT OPERATE</b> .....	<b>164</b>	<b>ROOF LINK ASSEMBLY</b> .....	<b>178</b>	
Diagnosis Procedure .....	164	Removal and Installation .....	178	E
<b>SQUEAK AND RATTLE TROUBLE DIAGNOSES</b> .....	<b>165</b>	<b>SUNROOF UNIT ASSEMBLY</b> .....	<b>179</b>	
Work Flow .....	165	Inspection and Adjustment .....	179	F
Generic Squeak and Rattle Troubleshooting .....	167	Exploded View .....	182	
Diagnostic Worksheet .....	169	Removal and Installation .....	182	G
<b>PRECAUTION</b> .....	<b>171</b>	<b>ROOF FINISHER</b> .....	<b>186</b>	
<b>PRECAUTIONS</b> .....	<b>171</b>	Removal and Installation .....	186	H
Precaution for Supplemental Restraint System (SRS) "AIR BAG" and "SEAT BELT PRE-TENSIONER" .....	171	<b>FRONT SUNROOF GLASS</b> .....	<b>188</b>	
Precautions .....	171	Removal and Installation .....	188	I
Precautions Necessary for Steering Wheel Rotation after Battery Disconnect (Early Production, With Electronic Steering Column Lock) .....	171	<b>REAR SUNROOF GLASS</b> .....	<b>190</b>	
<b>PREPARATION</b> .....	<b>173</b>	Removal and Installation .....	190	J
<b>PREPARATION</b> .....	<b>173</b>	<b>WIND DEFLECTOR</b> .....	<b>192</b>	
Special Service Tools .....	173	Removal and Installation .....	192	
Commercial Service Tools .....	173	<b>SUNSHADE</b> .....	<b>193</b>	
		Exploded View .....	193	
		Removal and Installation .....	193	
		<b>SUNROOF SWITCH</b> .....	<b>195</b>	
		Removal and Installation .....	195	

**RF**

L  
M  
N  
O  
P

# DIAGNOSIS AND REPAIR WORKFLOW

< BASIC INSPECTION >

[WITH SINGLE PANEL SUNROOF]

## BASIC INSPECTION

### DIAGNOSIS AND REPAIR WORKFLOW

Work Flow

INFOID:000000005461803

OVERALL SEQUENCE

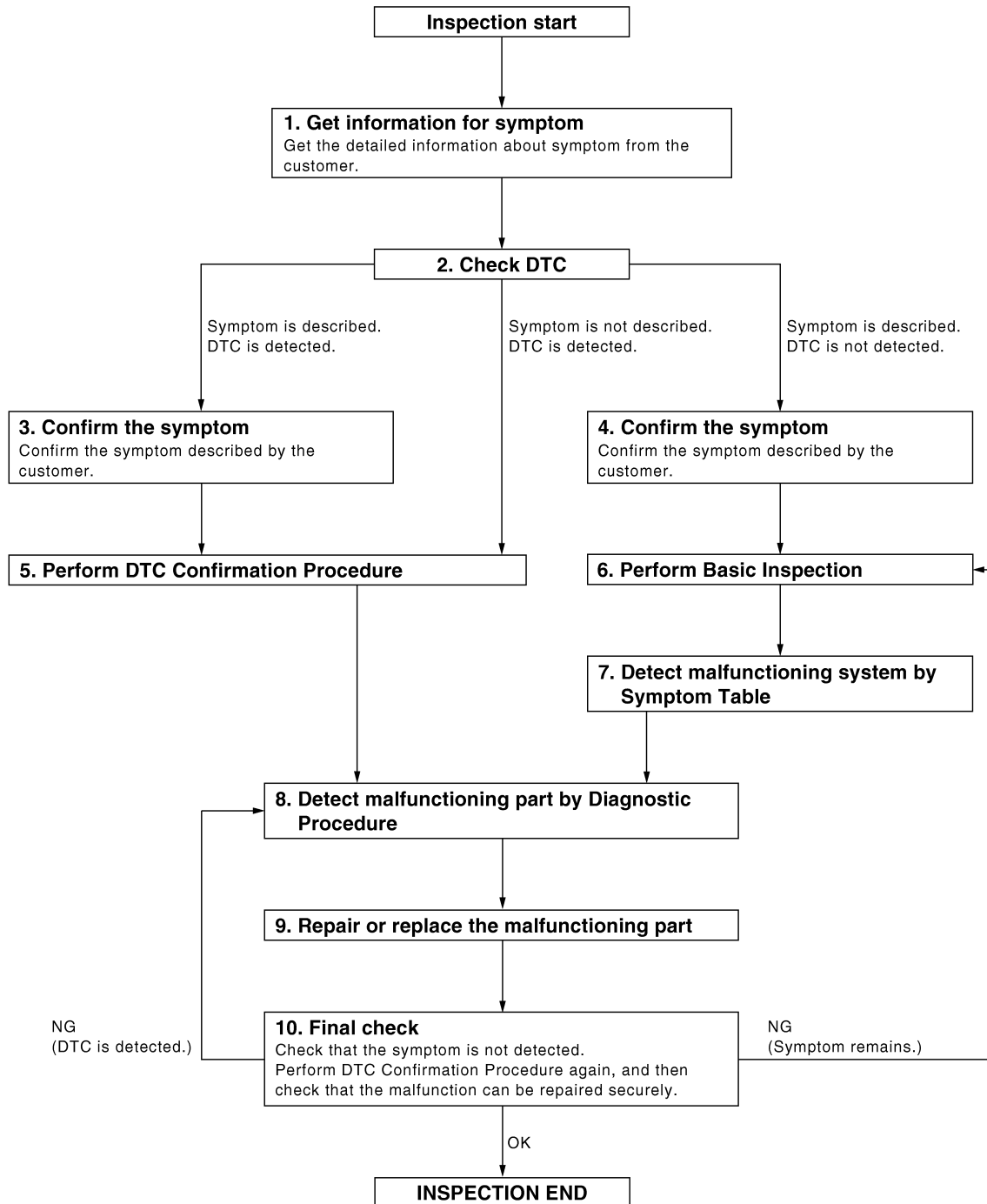

DETAILED FLOW

JMKIA0101GB

# DIAGNOSIS AND REPAIR WORKFLOW

< BASIC INSPECTION >

[WITH SINGLE PANEL SUNROOF]

## 1. GET INFORMATION FOR SYMPTOM

Get the detailed information from the customer about the symptom (the condition and the environment when the incident/malfunction occurred).

>> GO TO 2

## 2. CHECK DTC

1. Check DTC.
2. Perform the following procedure if DTC is displayed.
  - Record DTC and freeze frame data.
  - Erase DTC.
  - Study the relationship between the cause detected by DTC and the symptom described by the customer.
3. Check related service bulletins for information.

Is any symptom described and any DTC detected?

Symptom is described, DTC is displayed>>GO TO 3

Symptom is described, DTC is not displayed>>GO TO 4

Symptom is not described, DTC is displayed>>GO TO 5

## 3. CONFIRM THE SYMPTOM

Confirm the symptom described by the customer.

Connect CONSULT-III to the vehicle in "DATA MONITOR" mode and check real time diagnosis results. Verify relation between the symptom and the condition when the symptom is detected.

>> GO TO 5

## 4. CONFIRM THE SYMPTOM

Confirm the symptom described by the customer.

Connect CONSULT-III to the vehicle in "DATA MONITOR" mode and check real time diagnosis results. Verify relation between the symptom and the condition when the symptom is detected.

>> GO TO 6

## 5. PERFORM DTC CONFIRMATION PROCEDURE

Perform DTC Confirmation Procedure for the displayed DTC, and then check that DTC is detected again. At this time, always connect CONSULT-III to the vehicle, and check diagnostic results in real time.

If two or more DTCs are detected, refer to [BCS-79. "DTC Inspection Priority Chart"](#) and determine trouble diagnosis order.

### NOTE:

- Freeze frame data is useful if the DTC is not detected.
- Perform Component Function Check if DTC Confirmation Procedure is not included in Service Manual. This simplified check procedure is an effective alternative though DTC cannot be detected during this check. If the result of Component Function Check is NG, it is the same as the detection of DTC by DTC Confirmation Procedure.

Is DTC detected?

YES >> GO TO 8

NO >> Refer to [GI-39. "Intermittent Incident"](#).

## 6. PERFORM BASIC INSPECTION

Perform [RF-7. "BASIC INSPECTION : Special Repair Requirement"](#).

Inspection End>>GO TO 7

## 7. DETECT MALFUNCTIONING SYSTEM BY SYMPTOM DIAGNOSIS

Detect malfunctioning system according to symptom diagnosis based on the confirmed symptom in step 4, and determine the trouble diagnosis order based on possible causes and symptom.

>> GO TO 8

A  
B  
C  
D  
E  
F  
G  
H  
I  
J  
RF  
L  
M  
N  
O  
P

## DIAGNOSIS AND REPAIR WORKFLOW

< BASIC INSPECTION >

[WITH SINGLE PANEL SUNROOF]

---

### 8. DETECT MALFUNCTIONING PART BY DIAGNOSTIC PROCEDURE

---

Inspect according to Diagnostic Procedure of the system.

**NOTE:**

The Diagnostic Procedure described based on open circuit inspection. A short circuit inspection is also required for the circuit check in the Diagnostic Procedure.

Is malfunctioning part detected?

YES >> GO TO 9

NO >> Check voltage of related BCM terminals using CONSULT-III.

---

### 9. REPAIR OR REPLACE THE MALFUNCTIONING PART

---

1. Repair or replace the malfunctioning part.
2. Reconnect parts or connectors disconnected during Diagnostic Procedure again after repair and replacement.
3. Check DTC. If DTC is displayed, erase it.

>> GO TO 10

---

### 10. FINAL CHECK

---

When DTC was detected in step 2, perform DTC Confirmation Procedure or Component Function Check again, and then check that the malfunction has been repaired securely.

When symptom was described from the customer, refer to confirmed symptom in step 3 or 4, and check that the symptom is not detected.

Does the symptom reappear?

YES (DTC is detected)>>GO TO 8

YES (Symptom remains)>>GO TO 6

NO >> Inspection End.

# INSPECTION AND ADJUSTMENT

< BASIC INSPECTION >

[WITH SINGLE PANEL SUNROOF]

## INSPECTION AND ADJUSTMENT

### ADDITIONAL SERVICE WHEN REPLACING CONTROL UNIT

#### ADDITIONAL SERVICE WHEN REPLACING CONTROL UNIT : Description

INFOID:000000005461804

#### MEMORY RESET PROCEDURE

1. Please observe the following instructions at confirming the sunroof operation.

**NOTE:**

Do not disconnect the electronic power while the sunroof is operating or within 5 seconds after the sunroof stops (to wipe-out the memory of lid position and operating friction).

2. Initialization of system should be conducted after the following conditions.
  - When the sunroof motor is changed.
  - When the sunroof does not operate normally (incomplete initialization conditions).

#### ADDITIONAL SERVICE WHEN REPLACING CONTROL UNIT : Special Repair Requirement

INFOID:000000005461805

#### INITIALIZATION PROCEDURE

If the sunroof does not open or close automatically, use the following procedure to return sunroof operation to normal.

**NOTE:**

If the sunroof switch is released at any time during step 4, the procedure must be started over again. Leave the ignition switch ON for at least 2 seconds after this procedure.

1. Push the ignition switch to the ON position.
2. Hold the sunroof switch in the tilt up position. Release the switch when the sunroof has reached the full tilt up position.
3. Hold the sunroof switch in the tilt up position again. After a delay, the sunroof will back up. Release the switch.
4. Within 5 seconds of releasing the switch in step 3, hold the sunroof switch in the tilt up position again. The sunroof will move from the full tilt up position, to the open position and back to the close position. Release the switch only when the sunroof has reached the full closed position.

#### ANTI-PINCH FUNCTION

1. Full open the sunroof.
2. Place a piece of wood near fully closed position.
3. Close the sunroof completely with auto-slide close.

Check that sunroof lowers for approximately 150mm (5.91 in) or 2 seconds without pinching a piece of wood and stops.

**CAUTION:**

- Do not check with hands and other part of body because they may be pinched. Do not get pinched.
- Depending on environment and driving conditions, if a similar impact or load is applied to the sunroof it may lower.
- Check that auto-slide operates before inspection when system initialization is performed.
- Perform initial setting when auto-slide operation or anti-pinch function does not operate normally.

#### BASIC INSPECTION

#### BASIC INSPECTION : Special Repair Requirement

INFOID:000000005461806

#### BASIC INSPECTION

##### 1.INSPECTION START

1. Check the service history.
2. Check the following parts.
  - Fuse/circuit breaker blown.
  - Poor connection, open or short circuit of harness connector.

## INSPECTION AND ADJUSTMENT

< BASIC INSPECTION >

[WITH SINGLE PANEL SUNROOF]

---

- Battery voltage.

Is the inspection result normal?

YES >> Inspection End.

NO >> Repair or replace the malfunctioning parts.



# SUNROOF SYSTEM

< FUNCTION DIAGNOSIS >

[WITH SINGLE PANEL SUNROOF]

## FUNCTION DIAGNOSIS

### SUNROOF SYSTEM

#### System Diagram

INFOID:000000005461807

#### SUNROOF

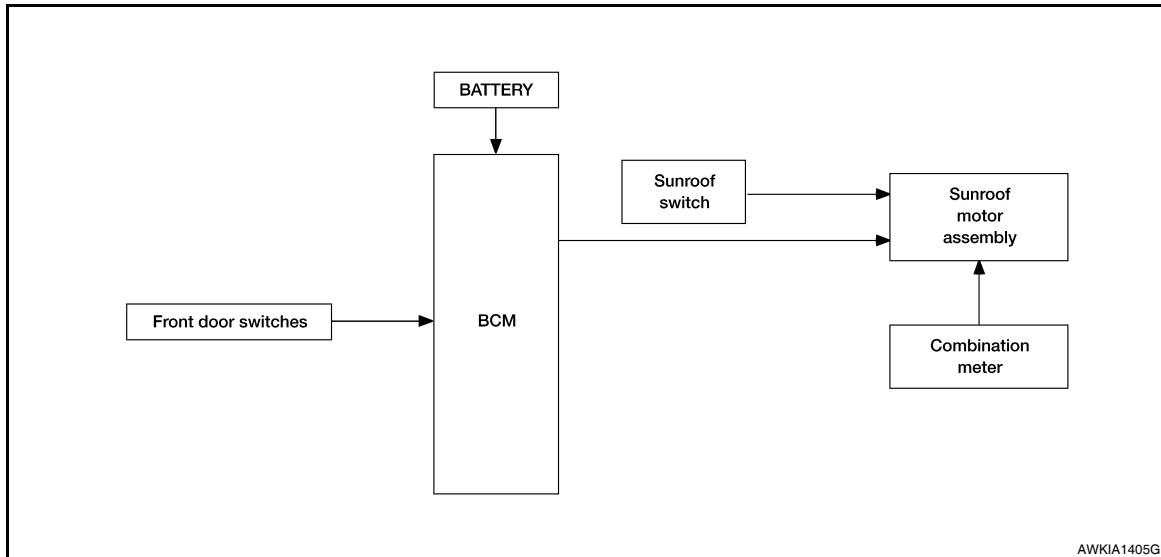

#### System Description

INFOID:000000005461808

#### SUNROOF SYSTEM

##### INPUT/OUTPUT SIGNAL CHART

Item	Input signal to sunroof motor assembly	Sunroof motor function	Actuator
Sunroof switch	Sunroof switch signal (tilt down or slide open)	Sunroof control	Sunroof motor
	Sunroof switch signal (tilt up or slide close)		
Combination meter	Vehicle speed signal		
BCM	RAP signal		

#### SUNROOF OPERATION

- Sunroof motor assembly operates with the power supply that is output from BCM while ignition switch is ON or retained power is operating.
- Tilt up/ down & slide open/ close signals from sunroof switch enable sunroof motor to move arbitrarily.
- Sunroof motor assembly receives a vehicle speed signal from combination meter and controls the sunroof motor torque of tilt down at the time of high speed operation.

#### AUTO OPERATION

Sunroof AUTO feature makes it possible to slide open and slide close or tilt up and tilt down the sunroof without holding the sunroof switch in the slide open/tilt down or slide close/tilt up position.

#### RETAINED POWER OPERATION

- Retained power operation is an additional power supply function that enables the sunroof system to operate during 45 seconds, even when ignition switch is turned OFF.

##### Retained power function cancel conditions

- Door CLOSE (door switch OFF)→OPEN (door switch ON).
- When ignition switch is ON again.
- When timer time passes (45 seconds).

#### ANTI-PINCH FUNCTION

# SUNROOF SYSTEM

[WITH SINGLE PANEL SUNROOF]

## < FUNCTION DIAGNOSIS >

The CPU of sunroof motor assembly monitors the sunroof motor operation and the sunroof position (fully-closed or other) by the signals from sunroof motor.

When sunroof motor detects an interruption during the following slide close and tilt down operation, sunroof switch controls the motor for open and the sunroof will operate until full up position (when tilt down operates) or 150 mm (5.91 in) or more in an open direction (when slide close operates):

- close operation and tilt down when ignition switch is in the "ON" position

## Component Parts Location

INFOID:000000005461809

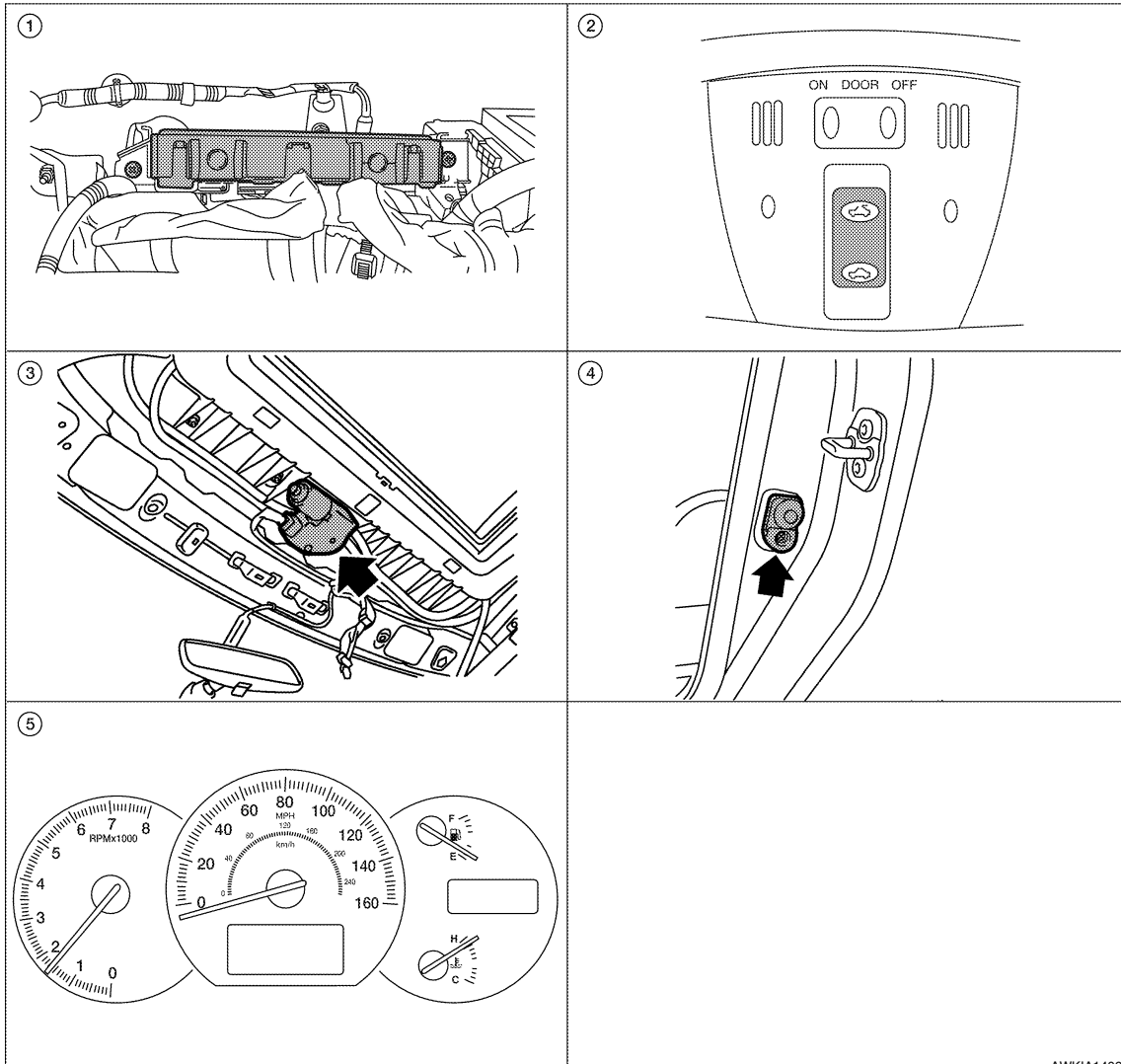

AWKIA1406ZZ

- |  |                          |                              |
|--|--------------------------|------------------------------|
| 1. BCM M16, M17, M18<br>(view with instrument panel removed) | 2. Sunroof switch R6     | 3. Sunroof motor assembly R5 |
| 4. Front door switch LH B8, RH B108                          | 5. Combination meter M24 |                              |

## Component Description

INFOID:000000005461810

Component	Function
BCM	Supplies the power supply to sunroof motor assembly.
Sunroof switch	Transmits tilt up/down & slides open/close operation signal to sunroof motor assembly.
Sunroof motor assembly	It is sunroof motor and CPU integrated type that enables tilt up/down & slide open/close by sunroof switch operation

# SUNROOF SYSTEM

< FUNCTION DIAGNOSIS >

[WITH SINGLE PANEL SUNROOF]

Component	Function
Front door switch	Detects door open/close condition and transmits to BCM.
Combination meter	Transmits vehicle speed signal to sunroof motor assembly.

A

B

C

D

E

F

G

H

I

J

RF

L

M

N

O

P

# DIAGNOSIS SYSTEM (BCM)

< FUNCTION DIAGNOSIS >

[WITH SINGLE PANEL SUNROOF]

## DIAGNOSIS SYSTEM (BCM)

### COMMON ITEM

#### COMMON ITEM : Diagnosis Description

INFOID:000000005511856

#### BCM CONSULT-III FUNCTION

CONSULT-III performs the following functions via CAN communication with BCM.

Diagnosis mode	Function Description
WORK SUPPORT	Changes the setting for each system function.
SELF DIAGNOSTIC RESULT	Displays the diagnosis results judged by BCM.
CAN DIAG SUPPORT MNTR	Monitors the reception status of CAN communication viewed from BCM.
DATA MONITOR	The BCM input/output signals are displayed.
ACTIVE TEST	The signals used to activate each device are forcibly supplied from BCM.
ECU IDENTIFICATION	The BCM part number is displayed.
CONFIGURATION	<ul style="list-style-type: none"><li>Enables to read and save the vehicle specification.</li><li>Enables to write the vehicle specification when replacing BCM.</li></ul>

#### SYSTEM APPLICATION

BCM can perform the following functions for each system.

#### NOTE:

It can perform the diagnosis modes except the following for all sub system selection items.

System	Sub system selection item	Diagnosis mode		
		WORK SUPPORT	DATA MONITOR	ACTIVE TEST
Door lock	DOOR LOCK	×	×	×
Rear window defogger	REAR DEFOGGER		×	×
Warning chime	BUZZER		×	×
Interior room lamp timer	INT LAMP	×	×	×
Exterior lamp	HEADLAMP	×	×	×
Wiper and washer	WIPER	×	×	×
Turn signal and hazard warning lamps	FLASHER	×	×	×
Intelligent Key system	INTELLIGENT KEY	×	×	×
Combination switch	COMB SW		×	
BCM	BCM	×		
Immobilizer	IMMU		×	×
Interior room lamp battery saver	BATTERY SAVER	×	×	×
Trunk open	TRUNK		×	×
Vehicle security system	THEFT ALM	×	×	×
RAP system	RETAINED PWR		×	
Signal buffer system	SIGNAL BUFFER		×	×
TPMS	AIR PRESSURE MONITOR	×	×	×

#### COMMON ITEM : CONSULT-III Function

INFOID:000000005511857

#### ECU IDENTIFICATION

Displays the BCM part No.

#### SELF-DIAG RESULT

Refer to [RF-141, "DTC Index"](#).

#### RETAINED PWR

# DIAGNOSIS SYSTEM (BCM)

< FUNCTION DIAGNOSIS >

[WITH SINGLE PANEL SUNROOF]

RETAINED PWR : CONSULT-III Function (BCM - RETAINED PWR)

INFOID:000000005511858

Data monitor

Monitor Item [Unit]	Description
DOOR SW-DR [ON/OFF]	Indicates condition of front door switch LH.
DOOR SW-AS [ON/OFF]	Indicates condition of front door switch RH.

A  
B  
C  
D  
E  
F  
G  
H  
I  
J  
RF  
L  
M  
N  
O  
P

# POWER SUPPLY AND GROUND CIRCUIT

< COMPONENT DIAGNOSIS >

[WITH SINGLE PANEL SUNROOF]

## COMPONENT DIAGNOSIS

### POWER SUPPLY AND GROUND CIRCUIT SUNROOF MOTOR ASSEMBLY

#### SUNROOF MOTOR ASSEMBLY : Description

INFOID:000000005461814

- BCM supplies power.
- CPU is integrated in sunroof motor assembly.
- Tilts up/down & slides open/close by sunroof switch operation.
- In order to close sunroof lid certainly with the signal from combination meter at the time of high speed run, the sunroof motor torque at the time of tilt-down operation is controlled.

#### SUNROOF MOTOR ASSEMBLY : Component Function Check

INFOID:000000005461815

##### 1. CHECK SUNROOF MOTOR FUNCTION

Do tilt up/down & slide open/close functions operate normally with sunroof switch?

Is the inspection result normal?

YES >> Sunroof motor assembly is OK.

NO >> Refer to [RF-14, "SUNROOF MOTOR ASSEMBLY : Diagnosis Procedure"](#).

#### SUNROOF MOTOR ASSEMBLY : Diagnosis Procedure

INFOID:000000005461816

Regarding Wiring Diagram information, refer to [RF-60, "Wiring Diagram"](#).

#### SUNROOF MOTOR ASSEMBLY

##### 1. CHECK POWER SUPPLY CIRCUIT

1. Turn ignition switch OFF.
2. Disconnect sunroof motor assembly.
3. Turn ignition switch ON.
4. Check voltage between sunroof motor assembly connector and ground.

Terminal		(-)	Voltage (V) (Approx.)
(+)	Terminal		
Sunroof motor assembly connector	4	Ground	Battery voltage
	19		
R5			

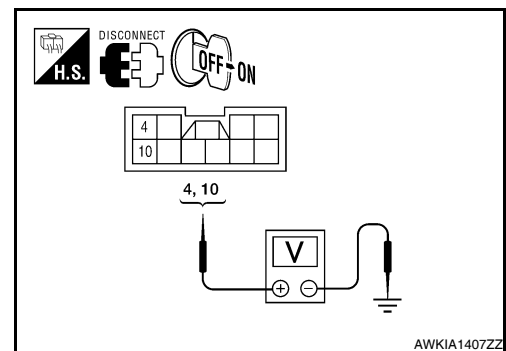

Is the measurement value within the specification?

YES >> GO TO 2

NO >> GO TO 3

##### 2. CHECK GROUND CIRCUIT

# POWER SUPPLY AND GROUND CIRCUIT

[WITH SINGLE PANEL SUNROOF]

## < COMPONENT DIAGNOSIS >

1. Turn ignition switch OFF.
2. Check continuity between sunroof motor assembly connector and ground.

Sunroof motor assembly connector	Terminal	Ground	Continuity
R5	8		Yes

Is the inspection result normal?

- YES >> GO TO 5  
 NO >> Repair or replace harness.

### 3. CHECK SUNROOF MOTOR CIRCUIT

1. Turn ignition switch OFF.
2. Disconnect BCM.
3. Check continuity between BCM connector (A) and sunroof motor assembly connector (B).

BCM connector	Terminal	Sunroof motor assembly connector	Terminal	Continuity
M16 (A)	2	R5 (B)	10	Yes
	3		4	

4. Check continuity between BCM connector (A) and ground.

BCM connector	Terminal	Ground	Continuity
M16 (A)	2		No
	3	No	

Is the inspection result normal?

- YES >> GO TO 4  
 NO >> Repair or replace harness.

### 4. CHECK BCM OUTPUT SIGNAL

1. Connect BCM.
2. Turn ignition switch ON.
3. Check voltage between BCM connector and ground.

Terminals		Voltage (V) (Approx.)
(+)	(-)	
BCM connector	Terminal	Battery voltage
M16	2	
	3	Ground

Is the measurement value within the specification?

- YES >> Check condition of harness and connector.  
 NO >> Replace BCM. Refer to [BCS-87. "Removal and Installation"](#).

### 5. CHECK SUNROOF SWITCH INPUT SIGNAL

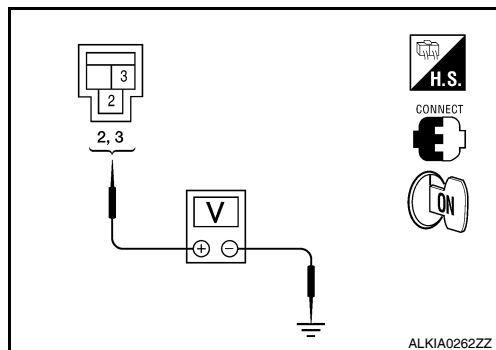
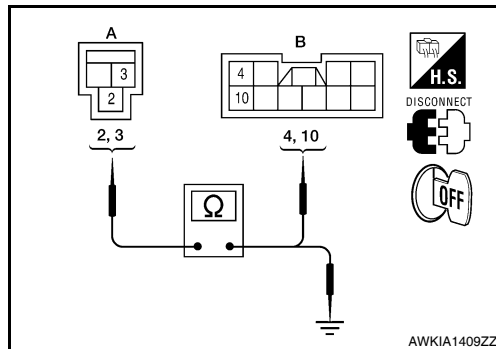
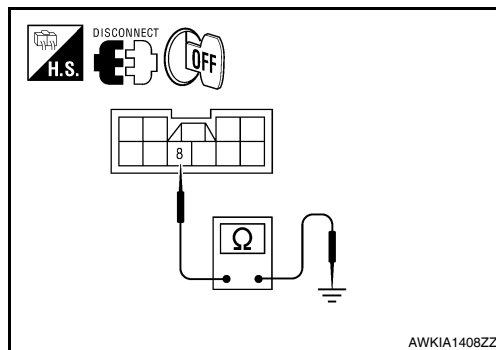

A  
B  
C  
D  
E  
F  
G  
H  
I  
J  
RF  
L  
M  
N  
O  
P

# POWER SUPPLY AND GROUND CIRCUIT

[WITH SINGLE PANEL SUNROOF]

## < COMPONENT DIAGNOSIS >

1. Connect sunroof motor assembly.
2. Turn ignition switch ON.
3. Check voltage between sunroof motor assembly connector and ground.

Sunroof motor assembly connector	Terminals		Condition	Voltage (V) (Approx.)
	(+)	(-)		
R5	6	Ground	Sunroof switch is operated TILT DOWN or SLIDE OPEN	0
			Other than above	Battery voltage
	2		Sunroof switch is operated TILT UP or SLIDE CLOSE	0
			Other than above	Battery voltage

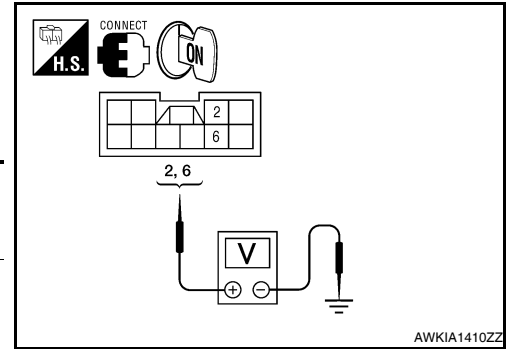

Is the measurement value within the specification?

YES >> GO TO 8

NO >> GO TO 6

## 6. CHECK SUNROOF SWITCH CIRCUIT

1. Turn ignition switch OFF.
2. Disconnect sunroof motor assembly and sunroof switch.
3. Check continuity between sunroof motor assembly connector (A) and sunroof switch connector (B).

Sunroof motor assembly connector	Terminal	Sunroof switch connector	Terminal	Continuity
R5 (A)	6	R6 (B)	1	Yes
	2		3	

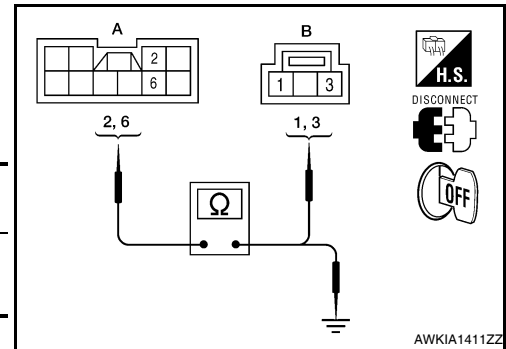

4. Check continuity between sunroof motor assembly connector (A) and ground.

Sunroof motor assembly connector	Terminal	Ground	Continuity
R5 (A)	6	Ground	No
	2		

Is the inspection result normal?

YES >> GO TO 7

NO >> Repair or replace harness.

## 7. CHECK SUNROOF SWITCH GROUND CIRCUIT

1. Connect sunroof motor assembly.
2. Check continuity between sunroof switch connector and ground.

Sunroof switch connector	Terminal	Ground	Continuity
R6	2	Ground	Yes

Is the inspection result normal?

YES >> Refer to [RF-17. "SUNROOF MOTOR ASSEMBLY : Component Inspection"](#).

NO >> Repair or replace harness.

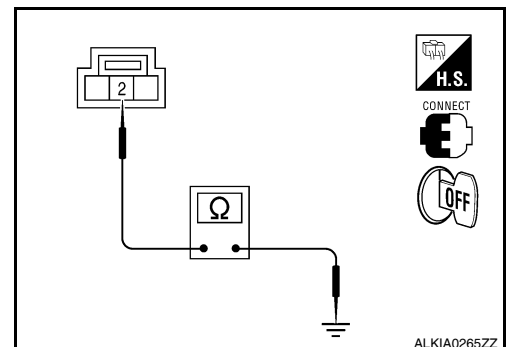

## 8. CHECK COMBINATION METER SIGNAL



# POWER SUPPLY AND GROUND CIRCUIT

[WITH SINGLE PANEL SUNROOF]

## < COMPONENT DIAGNOSIS >

1. Connect sunroof motor assembly.
2. Turn ignition switch ON.
3. Check signal between sunroof motor assembly connector and ground with oscilloscope.

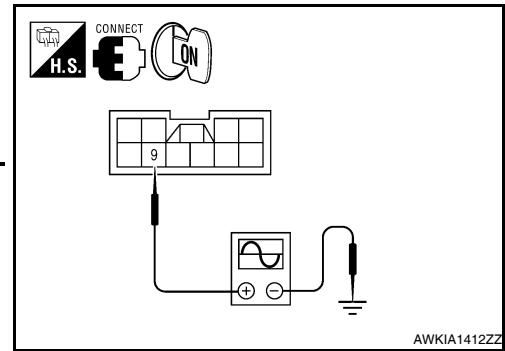

Terminals		Condition	Signal (Reference value)
(+)	(-)		
Sunroof motor assembly connector	Terminal		
R5	9	Speedometer operated [When vehicle speed is approx. 40km/h (25MPH)]	

ELF1080D

Is the inspection result normal?

YES >> Replace sunroof motor assembly. Refer to [RF-84, "Removal and Installation"](#). After that, refer to [RF-7, "ADDITIONAL SERVICE WHEN REPLACING CONTROL UNIT : Special Repair Requirement"](#).

NO >> GO TO 9

## 9. CHECK COMBINATION METER CIRCUIT

1. Turn ignition switch OFF.
2. Disconnect combination meter.
3. Check continuity between combination meter connector (A) and sunroof motor assembly connector (B).

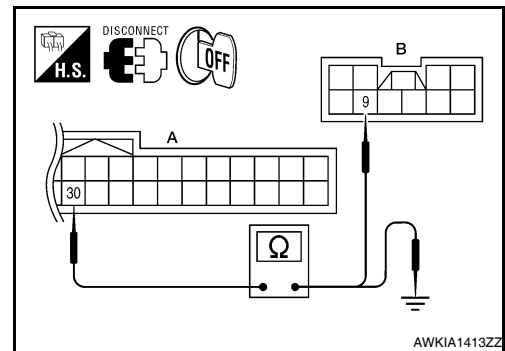

Combination meter connector	Terminal	Sunroof motor assembly connector	Terminal	Continuity
M24 (A)	30	R5 (B)	9	Yes

4. Check continuity between combination meter connector (A) and ground.

Combination meter connector	Terminal	Ground	Continuity
M24 (A)	30		No

Is the inspection result normal?

YES >> Replace combination meter. Refer to [MWI-140, "Removal and Installation"](#).

NO >> Repair or replace harness.

## SUNROOF MOTOR ASSEMBLY : Component Inspection

INFOID:000000005461817

### SUNROOF SWITCH

#### 1. CHECK SUNROOF SWITCH

# POWER SUPPLY AND GROUND CIRCUIT

< COMPONENT DIAGNOSIS >

[WITH SINGLE PANEL SUNROOF]

1. Turn ignition switch OFF.
2. Disconnect sunroof switch.
3. Check continuity between sunroof switch terminals.

Terminals	Condition	Continuity
1	Sunroof switch is operated TILT DOWN or SLIDE OPEN	Yes
	Other than above	No
3	Sunroof switch is operated TILT UP or SLIDE CLOSE	Yes
	Other than above	No

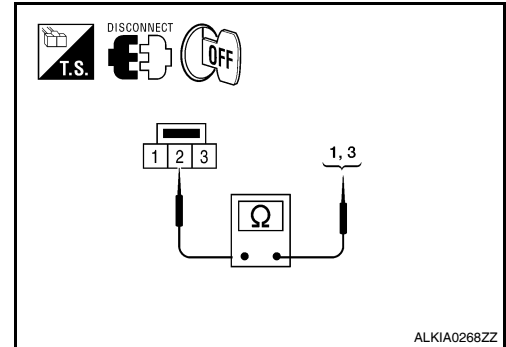

Is the inspection result normal?

YES >> Sunroof switch is OK.

NO >> Replace sunroof switch (map lamp assembly). Refer to [INL-97, "Removal and Installation"](#).

## SUNROOF MOTOR ASSEMBLY : Special Repair Requirement

INFOID:000000005461818

### 1. PERFORM INITIALIZATION PROCEDURE

Perform initialization procedure.

Refer to [RF-7, "ADDITIONAL SERVICE WHEN REPLACING CONTROL UNIT : Special Repair Requirement"](#).

>> GO TO 2

### 2. CHECK ANTI-PINCH OPERATION

Check anti-pinch operation.

Refer to [RF-7, "ADDITIONAL SERVICE WHEN REPLACING CONTROL UNIT : Special Repair Requirement"](#).

Is the inspection result normal?

YES >> Inspection End.

NO >> Check fitting adjustment. Refer to [RF-80, "Inspection"](#).

# DOOR SWITCH

< COMPONENT DIAGNOSIS >

[WITH SINGLE PANEL SUNROOF]

## DOOR SWITCH

### Description

INFOID:000000005461819

Detects door open/close condition.

### Component Function Check

INFOID:000000005461820

### 1.CHECK FUNCTION

#### With CONSULT-III

Check door switches DOOR SW-DR, DOOR SW-AS in Data Monitor mode with CONSULT-III.

Monitor item	Condition
DOOR SW-DR	CLOSE → OPEN: OFF → ON
DOOR SW-AS	

#### Is the inspection result normal?

- YES >> Door switch is OK.
- NO >> Refer to [RF-19, "Diagnosis Procedure"](#).

### Diagnosis Procedure

INFOID:000000005461821

Regarding Wiring Diagram information, refer to [RF-60, "Wiring Diagram"](#).

### 1.CHECK DOOR SWITCH INPUT SIGNAL

1. Turn ignition switch OFF.
2. Check signal between BCM connector and ground with oscilloscope.

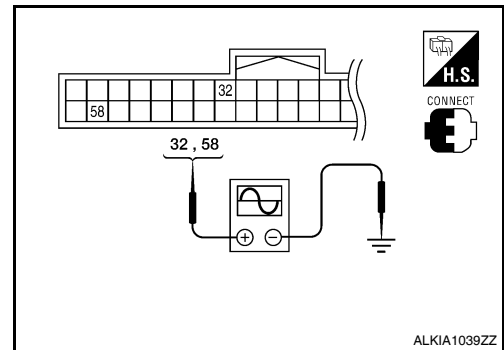

# DOOR SWITCH

< COMPONENT DIAGNOSIS >

[WITH SINGLE PANEL SUNROOF]

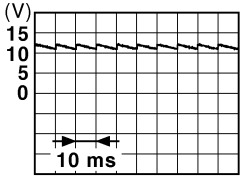
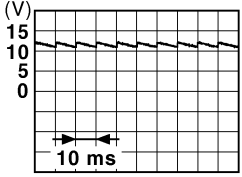
Terminals		(-)	Door condition	Voltage (V) (Approx.)
(+)				
BCM connector	Terminal			
A: M18	58	Ground	OPEN	0
			CLOSE	 <p style="text-align: right; font-size: small;">JPMA0011GB</p>
	OPEN		0	
	CLOSE		 <p style="text-align: right; font-size: small;">JPMA0011GB</p>	
32		Passenger side		

Is the inspection result normal?

- YES >> GO TO 4
- NO >> GO TO 2

## 2. CHECK DOOR SWITCH CIRCUIT

1. Disconnect BCM connector.
2. Check continuity between BCM connector and door switch connector.

BCM connector	Terminal	Door switch connector	Terminal	Continuity
A: M18	58	C: B8 (Driver side)	2	Yes
	32	C: B108 (Passenger side)		

3. Check continuity between BCM connector and ground.

BCM connector	Terminal	Ground	Continuity
A: M18	58	Ground	No
	32		

Is the inspection result normal?

- YES >> GO TO 3
- NO >> Repair or replace harness between BCM and door switch.

## 3. CHECK DOOR SWITCH

Refer to [RF-21. "Component Inspection"](#).

Is the inspection result normal?

- YES >> GO TO 4
- NO >> Replace malfunctioning door switch.

## 4. CHECK INTERMITTENT INCIDENT

Refer to [GI-39. "Intermittent Incident"](#).

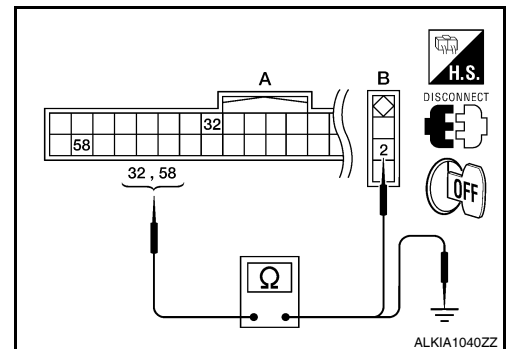

# DOOR SWITCH

[WITH SINGLE PANEL SUNROOF]

< COMPONENT DIAGNOSIS >

>> Inspection End.

## Component Inspection

INFOID:000000005461822

### 1. CHECK DOOR SWITCH

1. Turn ignition switch OFF.
2. Disconnect door switch connector.
3. Check door switch.

Terminal		Door switch condition	Continuity
Door switch			
2	Ground part of door switch	Pressed	No
		Released	Yes

Is the inspection result normal?

- YES >> Inspection End.  
NO >> Replace malfunctioning door switch.

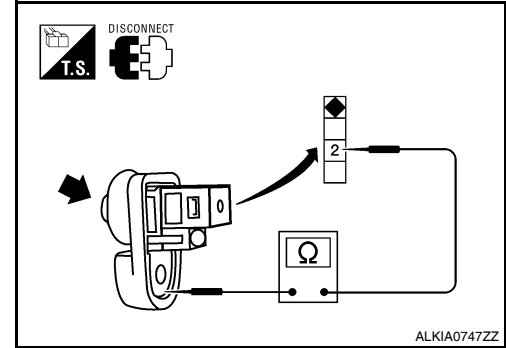

A  
B  
C  
D  
E  
F  
G  
H  
I  
J  
RF  
L  
M  
N  
O  
P

# BCM (BODY CONTROL MODULE)

< ECU DIAGNOSIS >

[WITH SINGLE PANEL SUNROOF]

## ECU DIAGNOSIS

### BCM (BODY CONTROL MODULE)

Reference Value

INFOID:00000000511859

#### VALUES ON THE DIAGNOSIS TOOL

Monitor Item	Condition	Value/Status
FR WIPER HI	Other than front wiper switch HI	OFF
	Front wiper switch HI	ON
FR WIPER LOW	Other than front wiper switch LO	OFF
	Front wiper switch LO	ON
FR WASHER SW	Front washer switch OFF	OFF
	Front washer switch ON	ON
FR WIPER INT	Other than front wiper switch INT	OFF
	Front wiper switch INT	ON
FR WIPER STOP	Front wiper is not in STOP position	OFF
	Front wiper is in STOP position	ON
INT VOLUME	Wiper intermittent dial is in a dial position 1 - 7	Wiper intermittent dial position
TURN SIGNAL R	Other than turn signal switch RH	OFF
	Turn signal switch RH	ON
TURN SIGNAL L	Other than turn signal switch LH	OFF
	Turn signal switch LH	ON
TAIL LAMP SW	Other than lighting switch 1ST and 2ND	OFF
	Lighting switch 1ST or 2ND	ON
HI BEAM SW	Other than lighting switch HI	OFF
	Lighting switch HI	ON
HEAD LAMP SW 1	Other than lighting switch 2ND	OFF
	Lighting switch 2ND	ON
HEAD LAMP SW 2	Other than lighting switch 2ND	OFF
	Lighting switch 2ND	ON
PASSING SW	Other than lighting switch PASS	OFF
	Lighting switch PASS	ON
AUTO LIGHT SW	Other than lighting switch AUTO	OFF
	Lighting switch AUTO	ON
FR FOG SW	Front fog lamp switch OFF	OFF
	Front fog lamp switch ON	ON
DOOR SW-DR	Driver door closed	OFF
	Driver door opened	ON
DOOR SW-AS	Passenger door closed	OFF
	Passenger door opened	ON
DOOR SW-RR	Rear door RH closed	OFF
	Rear door RH opened	ON
DOOR SW-RL	Rear door LH closed	OFF
	Rear door LH opened	ON

# BCM (BODY CONTROL MODULE)

< ECU DIAGNOSIS >

[WITH SINGLE PANEL SUNROOF]

Monitor Item	Condition	Value/Status	
CDL LOCK SW	Other than power door lock switch LOCK	OFF	A
	Power door lock switch LOCK	ON	
CDL UNLOCK SW	Other than power door lock switch UNLOCK	OFF	B
	Power door lock switch UNLOCK	ON	
KEY CYL LK-SW	Other than driver door key cylinder LOCK position	OFF	C
	Driver door key cylinder LOCK position	ON	
KEY CYL UN-SW	Other than driver door key cylinder UNLOCK position	OFF	D
	Driver door key cylinder UNLOCK position	ON	
HAZARD SW	When hazard switch is not pressed	OFF	E
	When hazard switch is pressed	ON	
REAR DEF SW	When rear window defogger switch is pressed	ON	E
TR CANCEL SW	Trunk lid opener cancel switch OFF	OFF	F
	Trunk lid opener cancel switch ON	ON	
TR/BD OPEN SW	Trunk lid opener switch OFF	OFF	F
	While the trunk lid opener switch is turned ON	ON	
TRNK/HAT MNTR	Trunk lid closed	OFF	G
	Trunk lid opened	ON	
RKE-LOCK	When LOCK button of Intelligent Key is not pressed	OFF	H
	When LOCK button of Intelligent Key is pressed	ON	
RKE-UNLOCK	When UNLOCK button of Intelligent Key is not pressed	OFF	I
	When UNLOCK button of Intelligent Key is pressed	ON	
RKE-TR/BD	When TRUNK OPEN button of Intelligent Key is not pressed	OFF	J
	When TRUNK OPEN button of Intelligent Key is pressed	ON	
RKE-PANIC	When PANIC button of Intelligent Key is not pressed	OFF	J
	When PANIC button of Intelligent Key is pressed	ON	
RKE-P/W OPEN	When UNLOCK button of Intelligent Key is not pressed and held	OFF	RF
	When UNLOCK button of Intelligent Key is pressed and held	ON	
RKE-MODE CHG	When LOCK/UNLOCK button of Intelligent Key is not pressed and held simultaneously	OFF	L
	When LOCK/UNLOCK button of Intelligent Key is pressed and held simultaneously	ON	
OPTICAL SENSOR	When outside of the vehicle is bright	Close to 5 V	M
	When outside of the vehicle is dark	Close to 0 V	
REQ SW-DR	When front door request switch is not pressed (driver side)	OFF	N
	When front door request switch is pressed (driver side)	ON	
REQ SW-AS	When front door request switch is not pressed (passenger side)	OFF	O
	When front door request switch is pressed (passenger side)	ON	
REQ SW-RL	When rear door request switch is not pressed (driver side)	OFF	P
	When rear door request switch is pressed (driver side)	ON	
REQ SW-RR	When rear door request switch is not pressed (passenger side)	OFF	P
	When rear door request switch is pressed (passenger side)	ON	
REQ SW-BD/TR	When trunk request switch is not pressed	OFF	
	When trunk request switch is pressed	ON	
PUSH SW	When engine switch (push switch) is not pressed	OFF	
	When engine switch (push switch) is pressed	ON	

# BCM (BODY CONTROL MODULE)

< ECU DIAGNOSIS >

[WITH SINGLE PANEL SUNROOF]

Monitor Item	Condition	Value/Status
IGN RLY 2-F/B	Ignition switch OFF or ACC	OFF
	Ignition switch ON	ON
ACC RLY-F/B	Ignition switch OFF	OFF
	Ignition switch ACC or ON	ON
BRAKE SW 1	When the brake pedal is not depressed	ON
	When the brake pedal is depressed	OFF
DETE/CANCL SW	When selector lever is in P position	OFF
	When selector lever is in any position other than P	ON
SFT PN/N SW	When selector lever is in any position other than P or N	OFF
	When selector lever is in P or N position	ON
S/L-LOCK*	Electronic steering column lock LOCK status	OFF
	Electronic steering column lock UNLOCK status	ON
S/L-UNLOCK*	Electronic steering column lock UNLOCK status	OFF
	Electronic steering column lock LOCK status	ON
S/L RELAY-F/B*	Ignition switch OFF or ACC	OFF
	Ignition switch ON	ON
UNLK SEN-DR	Driver door UNLOCK status	OFF
	Driver door LOCK status	ON
PUSH SW-IPDM	When engine switch (push switch) is not pressed	OFF
	When engine switch (push switch) is pressed	ON
IGN RLY1 F/B	Ignition switch OFF or ACC	OFF
	Ignition switch ON	ON
DETE SW -IPDM	When selector lever is in P position	OFF
	When selector lever is in any position other than P	ON
SFT PN -IPDM	When selector lever is in any position other than P or N	OFF
	When selector lever is in P or N position	ON
SFT P-MET	When selector lever is in any position other than P	OFF
	When selector lever is in P position	ON
SFT N-MET	When selector lever is in any position other than N	OFF
	When selector lever is in N position	ON
ENGINE STATE	Engine stopped	STOP
	While the engine stalls	STALL
	At engine cranking	CRANK
	Engine running	RUN
S/L LOCK-IPDM*	Electronic steering column lock LOCK status	OFF
	Electronic steering column lock UNLOCK status	ON
S/L UNLK-IPDM*	Electronic steering column lock UNLOCK status	OFF
	Electronic steering column lock LOCK status	ON
S/L RELAY-REQ*	Ignition switch OFF or ACC	OFF
	Ignition switch ON	ON
VEH SPEED 1	While driving	Equivalent to speedometer reading
VEH SPEED 2	While driving	Equivalent to speedometer reading



## BCM (BODY CONTROL MODULE)

< ECU DIAGNOSIS >

[WITH SINGLE PANEL SUNROOF]

Monitor Item	Condition	Value/Status	
DOOR STAT-DR	Driver door LOCK status	LOCK	A
	Wait with selective UNLOCK operation (5 seconds)	READY	
	Driver door UNLOCK status	UNLK	B
DOOR STAT-AS	Passenger door LOCK status	LOCK	
	Wait with selective UNLOCK operation (5 seconds)	READY	C
	Passenger door UNLOCK status	UNLK	
ID OK FLAG	Ignition switch ACC or ON	RESET	
	Ignition switch OFF	SET	D
PRMT ENG STRT	When the engine start is prohibited	RESET	
	When the engine start is permitted	SET	
KEY SW -SLOT	When Intelligent Key is not inserted into key slot	OFF	E
	When Intelligent Key is inserted into key slot	ON	
RKE OPE COUN1	During the operation of Intelligent Key	Operation frequency of Intelligent Key	F
CONFRM ID ALL	The key ID that the key slot receives does not accord with any key ID registered to BCM.	YET	
	The key ID that the key slot receives accords with any key ID registered to BCM.	DONE	G
CONFIRM ID4	The key ID that the key slot receives does not accord with the fourth key ID registered to BCM.	YET	
	The key ID that the key slot receives accords with the fourth key ID registered to BCM.	DONE	H
CONFIRM ID3	The key ID that the key slot receives does not accord with the third key ID registered to BCM.	YET	I
	The key ID that the key slot receives accords with the third key ID registered to BCM.	DONE	
CONFIRM ID2	The key ID that the key slot receives does not accord with the second key ID registered to BCM.	YET	J
	The key ID that the key slot receives accords with the second key ID registered to BCM.	DONE	RF
CONFIRM ID1	The key ID that the key slot receives does not accord with the first key ID registered to BCM.	YET	
	The key ID that the key slot receives accords with the first key ID registered to BCM.	DONE	L
TP 4	The ID of fourth key is not registered to BCM	YET	
	The ID of fourth key is registered to BCM	DONE	M
TP 3	The ID of third key is not registered to BCM	YET	
	The ID of third key is registered to BCM	DONE	N
TP 2	The ID of second key is not registered to BCM	YET	
	The ID of second key is registered to BCM	DONE	
TP 1	The ID of first key is not registered to BCM	YET	O
	The ID of first key is registered to BCM	DONE	
AIR PRESS FL	Ignition switch ON (only when the signal from the transmitter is received)	Air pressure of front LH tire	P
AIR PRESS FR	Ignition switch ON (only when the signal from the transmitter is received)	Air pressure of front RH tire	
AIR PRESS RR	Ignition switch ON (only when the signal from the transmitter is received)	Air pressure of rear RH tire	
AIR PRESS RL	Ignition switch ON (only when the signal from the transmitter is received)	Air pressure of rear LH tire	

# BCM (BODY CONTROL MODULE)

< ECU DIAGNOSIS >

[WITH SINGLE PANEL SUNROOF]

Monitor Item	Condition	Value/Status
ID REGST FL1	When ID of front LH tire transmitter is registered	DONE
	When ID of front LH tire transmitter is not registered	YET
ID REGST FR1	When ID of front RH tire transmitter is registered	DONE
	When ID of front RH tire transmitter is not registered	YET
ID REGST RR1	When ID of rear RH tire transmitter is registered	DONE
	When ID of rear RH tire transmitter is not registered	YET
ID REGST RL1	When ID of rear LH tire transmitter is registered	DONE
	When ID of rear LH tire transmitter is not registered	YET
WARNING LAMP	Tire pressure indicator OFF	OFF
	Tire pressure indicator ON	ON
BUZZER	Tire pressure warning alarm is not sounding	OFF
	Tire pressure warning alarm is sounding	ON

\* : With electronic steering column lock

# BCM (BODY CONTROL MODULE)

[WITH SINGLE PANEL SUNROOF]

< ECU DIAGNOSIS >

## Terminal Layout

INFOID:000000005511860

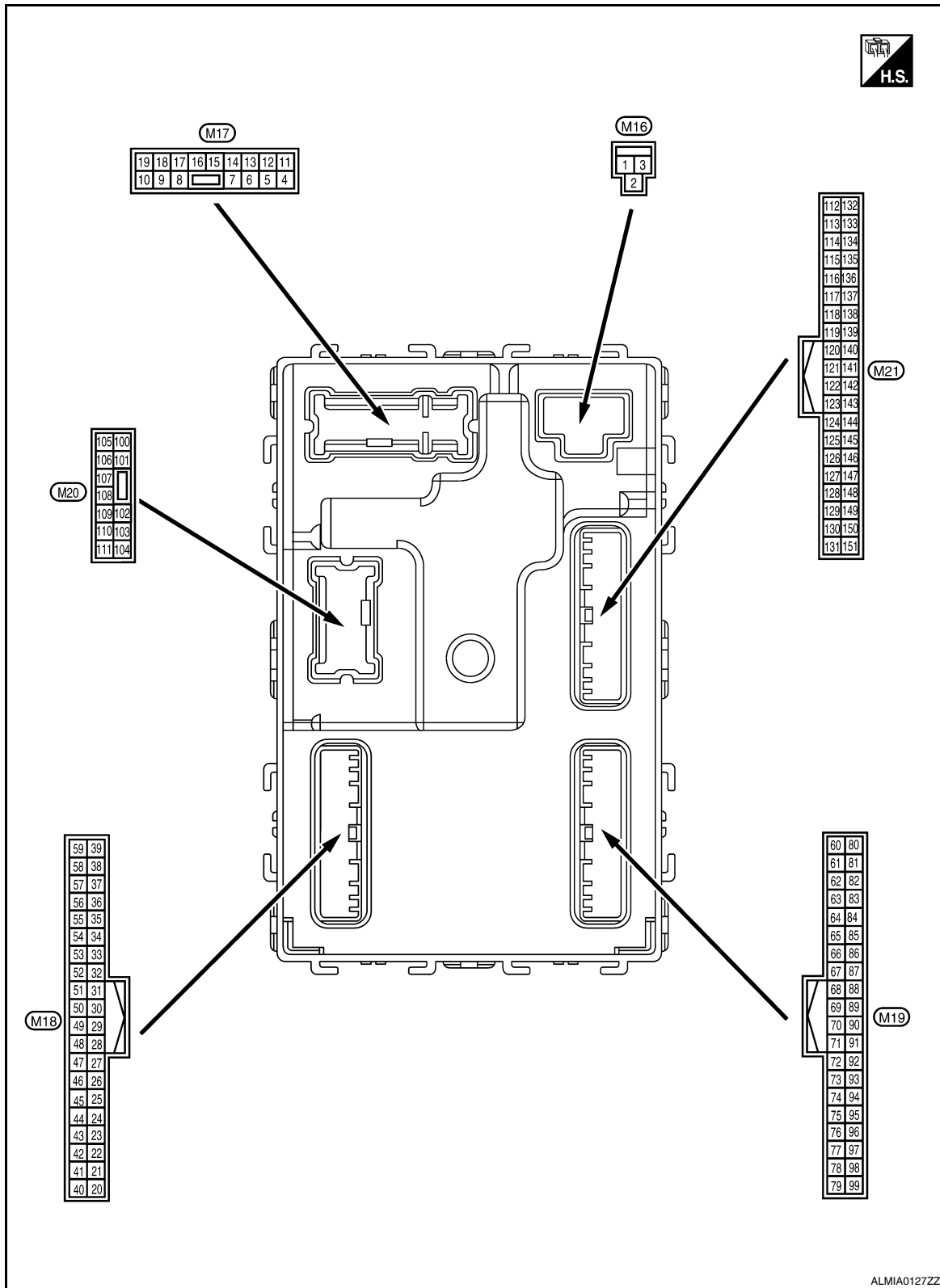

A  
B  
C  
D  
E  
F  
G  
H  
I  
J  
RF  
L  
M  
N  
O  
P

## Physical Values

INFOID:000000005511861

# BCM (BODY CONTROL MODULE)

< ECU DIAGNOSIS >

[WITH SINGLE PANEL SUNROOF]

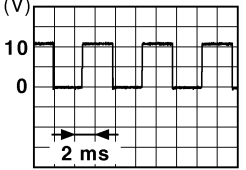
Terminal No. (Wire color)		Description		Condition		Value (Approx.)
		Signal name	Input/ Output			
(+)	(-)					
1 (W/B)	Ground	Battery power supply	Input	Ignition switch OFF		Battery voltage
2 (R/Y)	Ground	Battery power supply output	Output	Ignition switch OFF		Battery voltage
3 (L/W)	Ground	Ignition power supply output	Output	Ignition switch ON		Battery voltage
4 (P/W)	Ground	Interior room lamp power supply	Output	After passing the interior room lamp battery saver operation time		0V
				Any other time after passing the interior room lamp battery saver operation time		Battery voltage
5 (G)	Ground	Front door RH UNLOCK	Output	Front door RH	UNLOCK (actuator is activated)	Battery voltage
					Other than UNLOCK (actuator is not activated)	0V
7 (R/W)	Ground	Step lamp	Output	Step lamp	ON	0V
					OFF	Battery voltage
8 (V)	Ground	All doors LOCK	Output	All doors	LOCK (actuator is activated)	Battery voltage
					Other than LOCK (actuator is not activated)	0V
9 (L)	Ground	Front door LH UNLOCK	Output	Front door LH	UNLOCK (actuator is activated)	Battery voltage
					Other than UNLOCK (actuator is not activated)	0V
10 (G)	Ground	Rear door RH and rear door LH UNLOCK	Output	Rear door RH and rear door LH	UNLOCK (actuator is activated)	Battery voltage
					Other than UNLOCK (actuator is not activated)	0V
11 (Y/R)	Ground	Battery power supply	Input	Ignition switch OFF		Battery voltage
13 (B)	Ground	Ground	—	Ignition switch ON		0V
14 (GR/W)	Ground	Engine switch (push switch) illumination ground	Input	Tail lamp	OFF	0V
					ON	<b>NOTE:</b> When the illumination brightening/dimming level is in the neutral position 
15 (Y/L)	Ground	ACC indicator lamp	Output	Ignition switch	OFF	Battery voltage
					ACC or ON	0V

JSNIA0010GB

# BCM (BODY CONTROL MODULE)

[WITH SINGLE PANEL SUNROOF]

< ECU DIAGNOSIS >

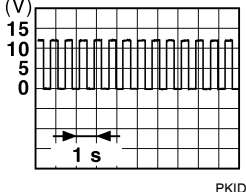
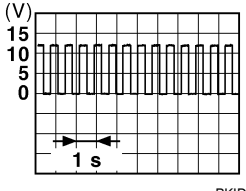
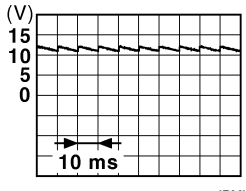
Terminal No. (Wire color)		Description		Condition		Value (Approx.)
(+)	(-)	Signal name	Input/ Output			
17 (G/B)	Ground	Turn signal (RH)	Output	Ignition switch ON	Turn signal switch OFF	0V
					Turn signal switch RH	
18 (G/Y)	Ground	Turn signal (LH)	Output	Ignition switch ON	Turn signal switch OFF	0V
					Turn signal switch LH	
19 (Y)	Ground	Room lamp timer control	Output	Interior room lamp	OFF	Battery voltage
					ON	0V
21 (P/B)	Ground	Optical sensor signal	Input	Ignition switch ON	When outside of the vehi- cle is bright	Close to 5V
					When outside of the vehi- cle is dark	Close to 0V
24 (R/W)	Ground	Stop lamp switch 1	Input	—	—	Battery voltage
26 (O/L)	Ground	Stop lamp switch 2	Input	Stop lamp switch	OFF (brake pedal is re- leased)	0V
					ON (brake pedal is de- pressed)	Battery voltage
27 (O)	Ground	Front door lock as- sembly LH (unlock sensor)	Input	Front door LH	LOCK status	
					UNLOCK status	0V
29 (Y)	Ground	Key slot switch	Input	When Intelligent Key is inserted into key slot	—	Battery voltage
				When Intelligent Key is not inserted into key slot	—	0V
30 (V/Y)	Ground	ACC feedback signal	Input	Ignition switch	OFF	0
					ACC or ON	Battery voltage
31 (G)	Ground	Rear window defog- ger feedback signal	Input	Rear window de- fogger switch	OFF	0V
					ON	Battery voltage



A  
B  
C  
D  
E  
F  
G  
H  
I  
J  
L  
M  
N  
O  
P

RF

# BCM (BODY CONTROL MODULE)

< ECU DIAGNOSIS >

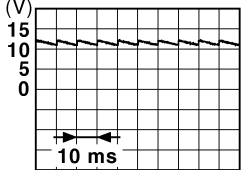
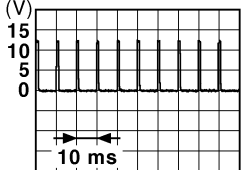
[WITH SINGLE PANEL SUNROOF]

Terminal No. (Wire color)		Description		Condition		Value (Approx.)
(+)	(-)	Signal name	Input/ Output			
32 (R/B)	Ground	Front door RH switch	Input	Front door RH switch	OFF (when front door RH closes)	 <small>JPMIA0011GB</small> 11.8 V
					ON (when front door RH opens)	0V
37 (O)	Ground	Trunk lid opener cancel switch	Input	Trunk lid opener cancel switch	CANCEL	 <small>JPMIA0012GB</small> 1.1V
					ON	0V
38 (GR/W)	Ground	Rear window defogger ON signal	Input	Rear window defogger switch	OFF	5V
					ON	0V
40 (Y/G)	Ground	Power window serial link	Input/ Output	Ignition switch ON	 <small>JPMIA0013GB</small> 10.2V	
				Ignition switch OFF or ACC	0V	
41 (W)	Ground	Engine switch (push switch) illumination	Output	Engine switch (push switch) illumination	ON	5.5V
					OFF	0V
42 (R)	Ground	LOCK indicator lamp	Output	LOCK indicator lamp	ON	0V
					OFF	Battery voltage
45 (P)	Ground	Receiver & sensor ground	Input	Ignition switch ON		0V
46 (V/W)	Ground	Receiver & sensor power supply output	Output	Ignition switch	OFF	0V
					ACC or ON	5.0V

# BCM (BODY CONTROL MODULE)

[WITH SINGLE PANEL SUNROOF]

< ECU DIAGNOSIS >

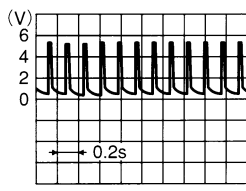
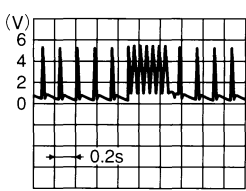
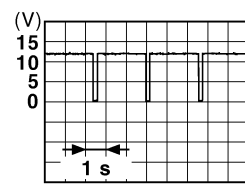
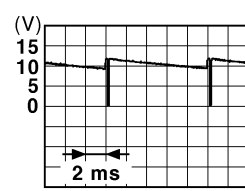
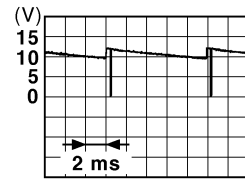
Terminal No. (Wire color)		Description		Condition	Value (Approx.)
(+)	(-)	Signal name	Input/ Output		
47 <sup>1</sup> (G/O)	Ground	Tire pressure receiver signal	Input/ Output	Ignition switch ON	Standby state  
				When receiving the signal from the transmitter  	
48 (R/G)	Ground	Selector lever transmission range switch signal	Input	Selector lever	P or N position 12.0V
				Except P and N positions	0V
49 (L/O)	Ground	Security indicator signal	Output	Security indicator	ON 0V
				Blinking  	11.3V
50 (LG/B)	Ground	Combination switch OUTPUT 5	Output	Combination switch (Wiper intermittent dial 4)	All switch OFF 0V
				Lighting switch 1ST	
				Lighting switch high-beam	
				Lighting switch 2ND	
				Turn signal switch RH	
10.7V					
51 (L/W)	Ground	Combination switch OUTPUT 1	Output	Combination switch	All switch OFF (Wiper intermittent dial 4) 0V
				Front wiper switch HI (Wiper intermittent dial 4)	
				Any of the conditions below with all switch OFF <ul style="list-style-type: none"> <li>• Wiper intermittent dial 1</li> <li>• Wiper intermittent dial 2</li> <li>• Wiper intermittent dial 3</li> <li>• Wiper intermittent dial 6</li> <li>• Wiper intermittent dial 7</li> </ul>	

A  
B  
C  
D  
E  
F  
G  
H  
I  
J  
K  
L  
M  
N  
O  
P

RF

# BCM (BODY CONTROL MODULE)

[WITH SINGLE PANEL SUNROOF]

< ECU DIAGNOSIS >

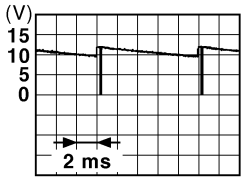
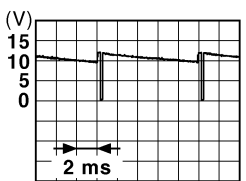
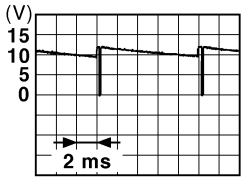
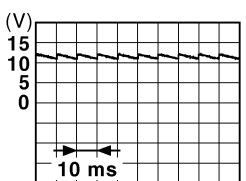
Terminal No. (Wire color)		Description		Condition	Value (Approx.)
(+)	(-)	Signal name	Input/ Output		
52 (G/B)	Ground	Combination switch OUTPUT 2	Output	Combination switch	All switch OFF (Wiper intermittent dial 4)
				Combination switch	Front washer switch ON (Wiper intermittent dial 4)
				Any of the conditions below with all switch OFF	 <p style="text-align: right;">10.7V</p>
53 (LG/ R)	Ground	Combination switch OUTPUT 3	Output	Combination switch (Wiper intermit- tent dial 4)	All switch OFF
				Combination switch (Wiper intermit- tent dial 4)	Front wiper switch INT
				Lighting switch AUTO	 <p style="text-align: right;">10.7V</p>
54 (G/Y)	Ground	Combination switch OUTPUT 4	Output	Combination switch (Wiper intermit- tent dial 4)	All switch OFF
				Combination switch (Wiper intermit- tent dial 4)	Front fog lamp switch ON
				Lighting switch 2ND	 <p style="text-align: right;">10.7V</p>
				Lighting switch flash-to- pass	
				Turn signal switch LH	
57 <sup>1</sup> (W)	Ground	Tire pressure warn- ing check switch	Input	—	5V
58 (SB)	Ground	Front door LH switch	Input	Front door LH switch	OFF (front door LH CLOSE)
					ON (front door LH OPEN)
					 <p style="text-align: right;">11.8V</p>
59 (G/R)	Ground	Rear window defog- ger relay	Output	Rear window de- fogger	Active
				Rear window de- fogger	Not activated
					Battery voltage
					0V



# BCM (BODY CONTROL MODULE)

[WITH SINGLE PANEL SUNROOF]

< ECU DIAGNOSIS >

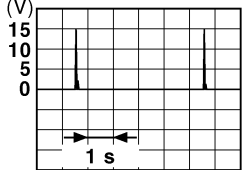
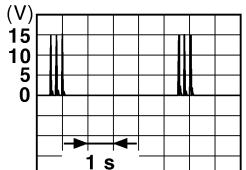
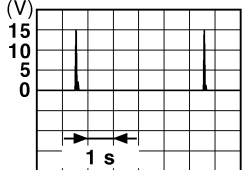
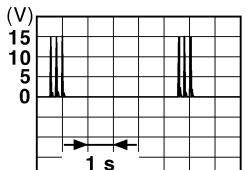
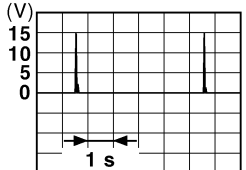
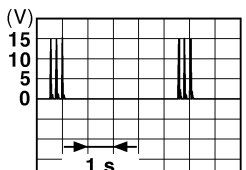
Terminal No. (Wire color)		Description		Condition	Value (Approx.)
(+)	(-)	Signal name	Input/ Output		
60 (B/R)	Ground	Front console antenna 2 (-)	Output	Ignition switch OFF	 <p>JMKIA0062GB</p>
				When Intelligent Key is not in the passenger compartment	 <p>JMKIA0063GB</p>
61 (W/R)	Ground	Center console antenna 2 (+)	Output	Ignition switch OFF	 <p>JMKIA0062GB</p>
				When Intelligent Key is not in the passenger compartment	 <p>JMKIA0063GB</p>
62 (V)	Ground	Front outside handle RH antenna (-)	Output	When the front door RH request switch is operated with ignition switch OFF	 <p>JMKIA0062GB</p>
				When Intelligent Key is not in the antenna detection area	 <p>JMKIA0063GB</p>

A  
B  
C  
D  
E  
F  
G  
H  
I  
J  
L  
M  
N  
O  
P

RF

# BCM (BODY CONTROL MODULE)

[WITH SINGLE PANEL SUNROOF]

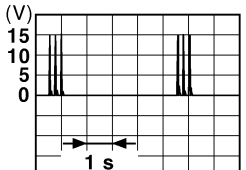
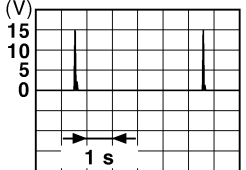
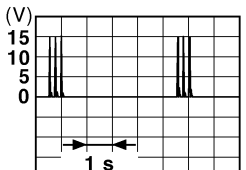
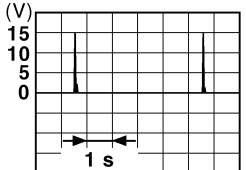
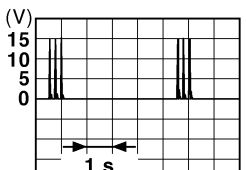

< ECU DIAGNOSIS >

Terminal No. (Wire color)		Description		Condition	Value (Approx.)
(+)	(-)	Signal name	Input/ Output		
63 (P)	Ground	Front outside handle RH antenna (+)	Output		
				When the front door RH request switch is operat- ed with ignition switch OFF	 <p style="text-align: right; font-size: small;">JMKIA0063GB</p>
64 (V)	Ground	Front outside handle LH antenna (-)	Output	When Intelligent Key is in the antenna detection area	 <p style="text-align: right; font-size: small;">JMKIA0062GB</p>
				When the front door LH request switch is operat- ed with ignition switch OFF	 <p style="text-align: right; font-size: small;">JMKIA0063GB</p>
65 (P)	Ground	Front outside handle LH antenna (+)	Output	When Intelligent Key is in the antenna detection area	 <p style="text-align: right; font-size: small;">JMKIA0062GB</p>
				When the front door LH request switch is operat- ed with ignition switch OFF	 <p style="text-align: right; font-size: small;">JMKIA0063GB</p>

# BCM (BODY CONTROL MODULE)

[WITH SINGLE PANEL SUNROOF]

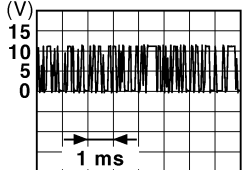
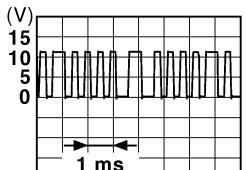
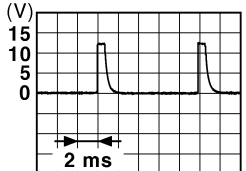
< ECU DIAGNOSIS >

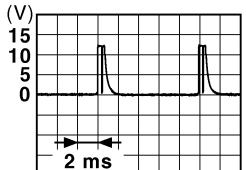

Terminal No. (Wire color)		Description		Condition	Value (Approx.)	
		Signal name	Input/ Output			
(+)	(-)					
68 (G/O)	Ground	NATS antenna amp (built in key slot)	Input/ Output	During waiting	Ignition switch is pressed while inserting the Intelligent Key into the key slot.	Just after pressing ignition switch. Pointer of tester should move.
69 (O)	Ground	NATS antenna amp (built in key slot)	Input/ Output	During waiting	Ignition switch is pressed while inserting the Intelligent Key into the key slot.	Just after pressing ignition switch. Pointer of tester should move.
70 (R/B)	Ground	Ignition relay-2 control	Output	Ignition switch	OFF or ACC	0V
					ON	Battery voltage
71 (L/O)	Ground	Remote keyless entry receiver signal	Input/ Output	During waiting		 <p style="text-align: right; font-size: small;">JMKIA0064GB</p>
				When operating either button on Intelligent Key		 <p style="text-align: right; font-size: small;">JMKIA0065GB</p>
75 (R/Y)	Ground	Combination switch INPUT 5	Input	Combination switch	All switch OFF (Wiper intermittent dial 4)	 <p style="text-align: right; font-size: small;">JPMIA0041GB</p> <p style="text-align: center;">1.4V</p>
				Combination switch	Front fog lamp switch ON (Wiper intermittent dial 4)	 <p style="text-align: right; font-size: small;">JPMIA0037GB</p> <p style="text-align: center;">1.3V</p>
				Combination switch	Any of the conditions below with all switch OFF	 <p style="text-align: right; font-size: small;">JPMIA0040GB</p> <p style="text-align: center;">1.3V</p>

A  
B  
C  
D  
E  
F  
G  
H  
I  
J  
RF  
L  
M  
N  
O  
P

# BCM (BODY CONTROL MODULE)

< ECU DIAGNOSIS >

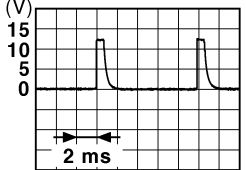
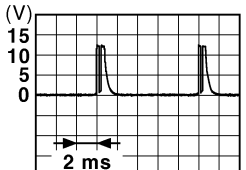
[WITH SINGLE PANEL SUNROOF]

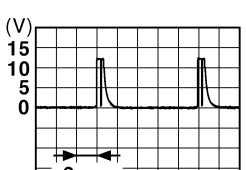
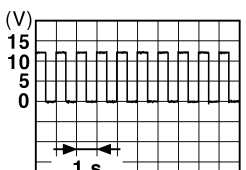
Terminal No. (Wire color)		Description		Condition	Value (Approx.)	
(+)	(-)	Signal name	Input/ Output			
76 (R/G)	Ground	Combination switch INPUT 3	Input	Combination switch	All switch OFF (Wiper intermittent dial 4)	 <small>JPMIA0041GB</small> 1.4V
					Lighting switch high-beam (Wiper intermittent dial 4)	 <small>JPMIA0036GB</small> 1.3V
					Lighting switch 2ND (Wiper intermittent dial 4)	 <small>JPMIA0037GB</small> 1.3V
					Any of the conditions below with all switch OFF • Wiper intermittent dial 1 • Wiper intermittent dial 2 • Wiper intermittent dial 3	 <small>JPMIA0040GB</small> 1.3V
77 <sup>2</sup> (BR)	Ground	Engine switch (push switch)	Input	Engine switch (push switch)	Pressed Not pressed	0V Battery voltage
78 (P)	Ground	CAN-L	Input/ Output	—	—	—
79 (L)	Ground	CAN-H	Input/ Output	—	—	—
80 (R/L)	Ground	Key slot illumination	Output	Key slot illumina- tion	OFF	0V
					Blinking	 <small>JPMIA0015GB</small> 6.5V
					ON	Battery voltage

# BCM (BODY CONTROL MODULE)

< ECU DIAGNOSIS >

[WITH SINGLE PANEL SUNROOF]

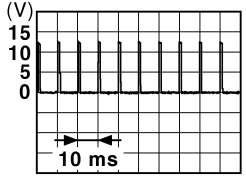
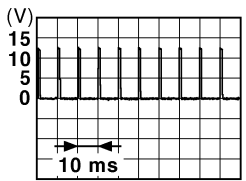

Terminal No. (Wire color)		Description		Condition		Value (Approx.)
		Signal name	Input/ Output			
(+)	(-)					
81 (LG)	Ground	ON indicator lamp	Output	Ignition switch	OFF or ACC	0V
					ON	Battery voltage
83 (L)	Ground	ACC relay control	Output	Ignition switch	OFF	0V
					ACC or ON	Battery voltage
84 (Y/R)	Ground	CVT shift selector	Output	—		Battery voltage
85 <sup>3</sup> (L/O)	Ground	Electronic steering column lock condition No. 1	Input	Electronic steering column lock	Lock status	0V
					Unlock status	Battery voltage
86 <sup>3</sup> (G/R)	Ground	Electronic steering column lock condition No. 2	Input	Electronic steering column lock	Lock status	Battery voltage
					Unlock status	0V
87 (G/B)	Ground	Selector lever P position switch	Input	Selector lever	P position	0V
					Any position other than P	Battery voltage
88 (R)	Ground	Front door RH request switch	Input	Front door RH request switch	ON (pressed)	0V
					OFF (not pressed)	 <p style="text-align: right; font-size: small;">JPMIA0016GB 1.0V</p>
89 (R)	Ground	Front door LH request switch	Input	Front door LH request switch	ON (pressed)	0V
					OFF (not pressed)	 <p style="text-align: right; font-size: small;">JPMIA0016GB 1.0V</p>
90 (Y)	Ground	Blower fan motor relay control	Output	Ignition switch	OFF or ACC	0V
					ON	Battery voltage
91 (L/R)	Ground	Remote keyless entry receiver power supply	Output	Ignition switch OFF		Battery voltage
94 <sup>3</sup> (G/Y)	Ground	Steering wheel lock unit power supply	Output	Ignition switch	OFF or ACC	Battery voltage
					ON	0V

A  
B  
C  
D  
E  
F  
G  
H  
I  
J  
RF  
L  
M  
N  
O  
P

# BCM (BODY CONTROL MODULE)

[WITH SINGLE PANEL SUNROOF]

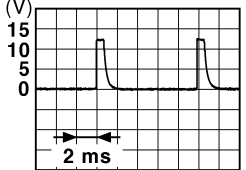
< ECU DIAGNOSIS >

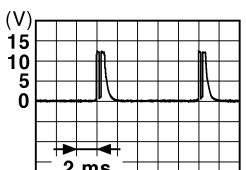
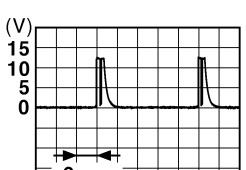
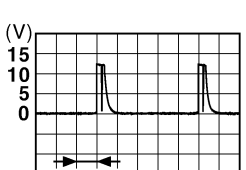
Terminal No. (Wire color)		Description		Condition	Value (Approx.)
(+)	(-)	Signal name	Input/ Output		
95 (R/W)	Ground	Combination switch INPUT 1	Input	All switch OFF	 1.4V
				Turn signal switch LH	 1.3V
				Turn signal switch RH	 1.3V
				Front wiper switch LO	 1.3V
				Front washer switch ON	 1.3V

# BCM (BODY CONTROL MODULE)

[WITH SINGLE PANEL SUNROOF]

< ECU DIAGNOSIS >

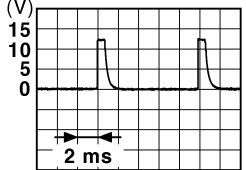
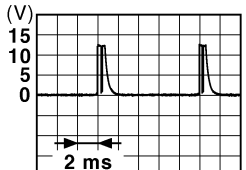
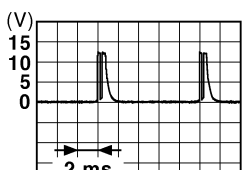
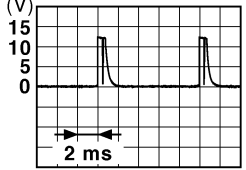
Terminal No. (Wire color)		Description		Condition	Value (Approx.)
(+)	(-)	Signal name	Input/ Output		
96 (P/B)	Ground	Combination switch INPUT 4	Input	Combination switch	All switch OFF (Wiper intermittent dial 4)  1.4V
					Lighting switch AUTO (Wiper intermittent dial 4)  1.3V
					Lighting switch 1ST (Wiper intermittent dial 4)  1.3V
					Any of the conditions below with all switch OFF <ul style="list-style-type: none"> <li>• Wiper intermittent dial 1</li> <li>• Wiper intermittent dial 5</li> <li>• Wiper intermittent dial 6</li> </ul>  1.3V

A  
B  
C  
D  
E  
F  
G  
H  
I  
J  
RF  
L  
M  
N  
O  
P

# BCM (BODY CONTROL MODULE)

[WITH SINGLE PANEL SUNROOF]

< ECU DIAGNOSIS >

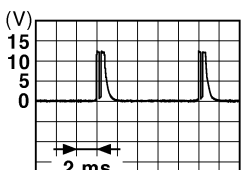
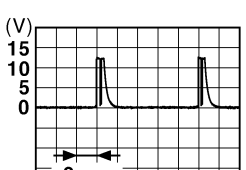
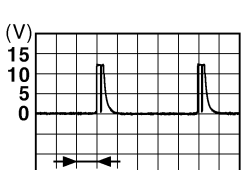
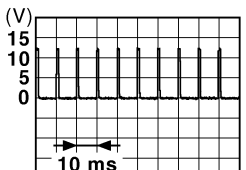
Terminal No. (Wire color)		Description		Condition	Value (Approx.)	
(+)	(-)	Signal name	Input/ Output			
97 (R/B)	Ground	Combination switch INPUT 2	Input			Combination switch (Wiper intermittent dial 4)
				Lighting switch flash-to-pass	 1.3V	
				Lighting switch 2ND	 1.3V	
				Front wiper switch INT	 1.3V	
				Front wiper switch HI	 1.3V	
				Pressed	0 V	
98 (G/O)	Ground	Hazard switch	Input	Hazard switch	Not pressed	 1.1V



# BCM (BODY CONTROL MODULE)

[WITH SINGLE PANEL SUNROOF]

< ECU DIAGNOSIS >

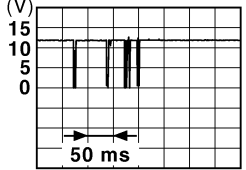
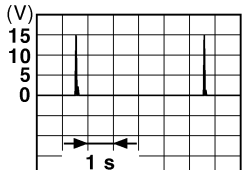
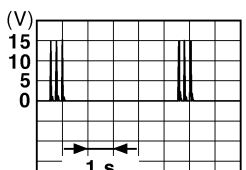
Terminal No. (Wire color)		Description		Condition	Value (Approx.)	
(+)	(-)	Signal name	Input/ Output			
99 <sup>3</sup> (L/Y)	Ground	Electronic steering column lock unit com- munication	Input/ Output	Electronic steer- ing column lock	LOCK status	Battery voltage
					LOCK or UNLOCK	 <p style="text-align: right; font-size: small;">JMKIA0066GB</p>
					For 15 seconds after UN- LOCK	Battery voltage
					15 seconds or later after UNLOCK	0V
103 (V)	Ground	Trunk lid opening.	Output	Trunk lid	Open (trunk lid opener ac- tuator is activated)	Battery voltage
					Close (trunk lid opener ac- tuator is not activated)	0V
110 (V/W)	Ground	Trunk room lamp	Output	Trunk room lamp	ON	0V
					OFF	Battery voltage
114 (B)	Ground	Trunk room antenna 1 (-)	Output	Ignition switch OFF	When Intelligent Key is in the passenger compart- ment	 <p style="text-align: right; font-size: small;">JMKIA0062GB</p>
					When Intelligent Key is not in the passenger compart- ment	 <p style="text-align: right; font-size: small;">JMKIA0063GB</p>

A  
B  
C  
D  
E  
F  
G  
H  
I  
J  
RF  
L  
M  
N  
O  
P

# BCM (BODY CONTROL MODULE)

[WITH SINGLE PANEL SUNROOF]

< ECU DIAGNOSIS >

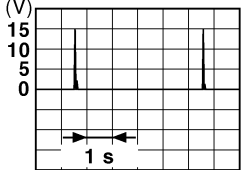
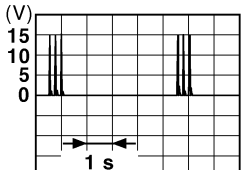
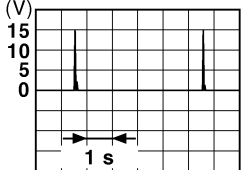
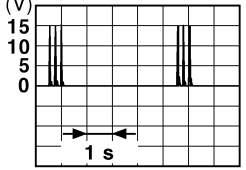
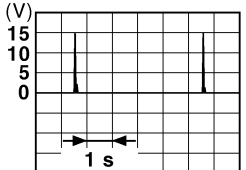
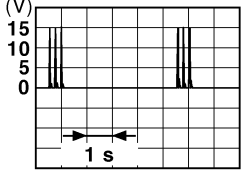
Terminal No. (Wire color)		Description		Condition	Value (Approx.)
(+)	(-)	Signal name	Input/ Output		
115 (W)	Ground	Trunk room antenna 1 (+)	Output	Ignition switch OFF	 <p style="text-align: right; font-size: small;">JMKIA0062GB</p>
				When Intelligent Key is not in the passenger compart- ment	 <p style="text-align: right; font-size: small;">JMKIA0063GB</p>
118 (L/O)	Ground	Rear bumper anten- na (-)	Output	When the trunk lid request switch is operated with ignition switch OFF	 <p style="text-align: right; font-size: small;">JMKIA0062GB</p>
				When Intelligent Key is not in the antenna detection area	 <p style="text-align: right; font-size: small;">JMKIA0063GB</p>
119 (BR/ W)	Ground	Rear bumper anten- na (+)	Output	When the trunk lid request switch is operated with ignition switch OFF	 <p style="text-align: right; font-size: small;">JMKIA0062GB</p>
				When Intelligent Key is not in the antenna detection area	 <p style="text-align: right; font-size: small;">JMKIA0063GB</p>

# BCM (BODY CONTROL MODULE)

[WITH SINGLE PANEL SUNROOF]

< ECU DIAGNOSIS >

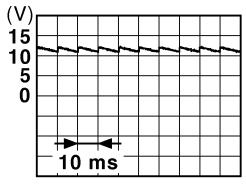
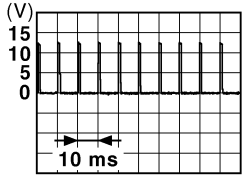
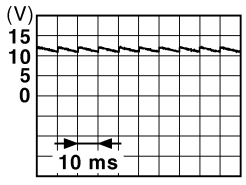
Terminal No. (Wire color)		Description		Condition	Value (Approx.)	
		Signal name	Input/ Output			
(+)	(-)					
127 (BR/ W)	Ground	Ignition relay (IPDM E/R) control	Output	Ignition switch	OFF or ACC	Battery voltage
					ON	0V
130 (W)	Ground	Trunk room lamp switch	Input	Trunk room lamp switch	OFF (trunk is closed)	 <p style="text-align: right; margin-right: 50px;">11.8V</p> <p style="text-align: right; font-size: small;">JPMIA0011GB</p>
					ON (trunk is open)	0V
132 (R)	Ground	Starter motor relay control	Output	Ignition switch ON	When selector lever is in P or N position and the brake is depressed	Battery voltage
					When selector lever is in P or N position and the brake is not depressed	0V
140 <sup>4</sup> (L/R)	Ground	Engine switch (push switch)	Input	Engine switch (push switch)	Pressed	0V
					Not pressed	Battery voltage
141 (BR)	Ground	Trunk request switch	Input	Trunk request switch	ON (pressed)	0V
					OFF (not pressed)	 <p style="text-align: right; margin-right: 50px;">1.0V</p> <p style="text-align: right; font-size: small;">JPMIA0016GB</p>
144 (GR)	Ground	Request switch buzz- er	Output	Request switch buzzer	Sounding	0V
					Not sounding	Battery voltage
147 (L/R)	Ground	Trunk lid opener switch	Input	Trunk lid opener switch	Pressed	0V
					Not pressed	Battery voltage
148 (R/W)	Ground	Rear door RH switch	Input	Rear door RH switch	OFF (when rear door RH closes)	 <p style="text-align: right; margin-right: 50px;">11.8V</p> <p style="text-align: right; font-size: small;">JPMIA0011GB</p>
					ON (when rear door RH opens)	0V

A  
B  
C  
D  
E  
F  
G  
H  
I  
J  
RF  
L  
M  
N  
O  
P

# BCM (BODY CONTROL MODULE)

< ECU DIAGNOSIS >

[WITH SINGLE PANEL SUNROOF]

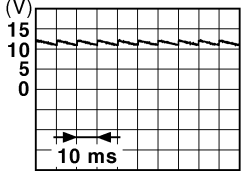
Terminal No. (Wire color)		Description		Condition		Value (Approx.)
(+)	(-)	Signal name	Input/ Output			
149 (R/B)	Ground	Rear door LH switch	Input	Rear door LH switch	OFF (when rear door LH closes)	 <p style="text-align: right; font-size: small;">JPMIA0011GB</p>
				ON (when rear door LH opens)	0V	

- 1 : With low tire pressure monitoring system
- 2 : With electronic steering column lock
- 3 : Early production
- 4 : Without electronic steering column lock

# BCM (BODY CONTROL MODULE)

[WITH SINGLE PANEL SUNROOF]

< ECU DIAGNOSIS >

## Wiring Diagram

INFOID:000000005511862

### BCM (BODY CONTROL MODULE)

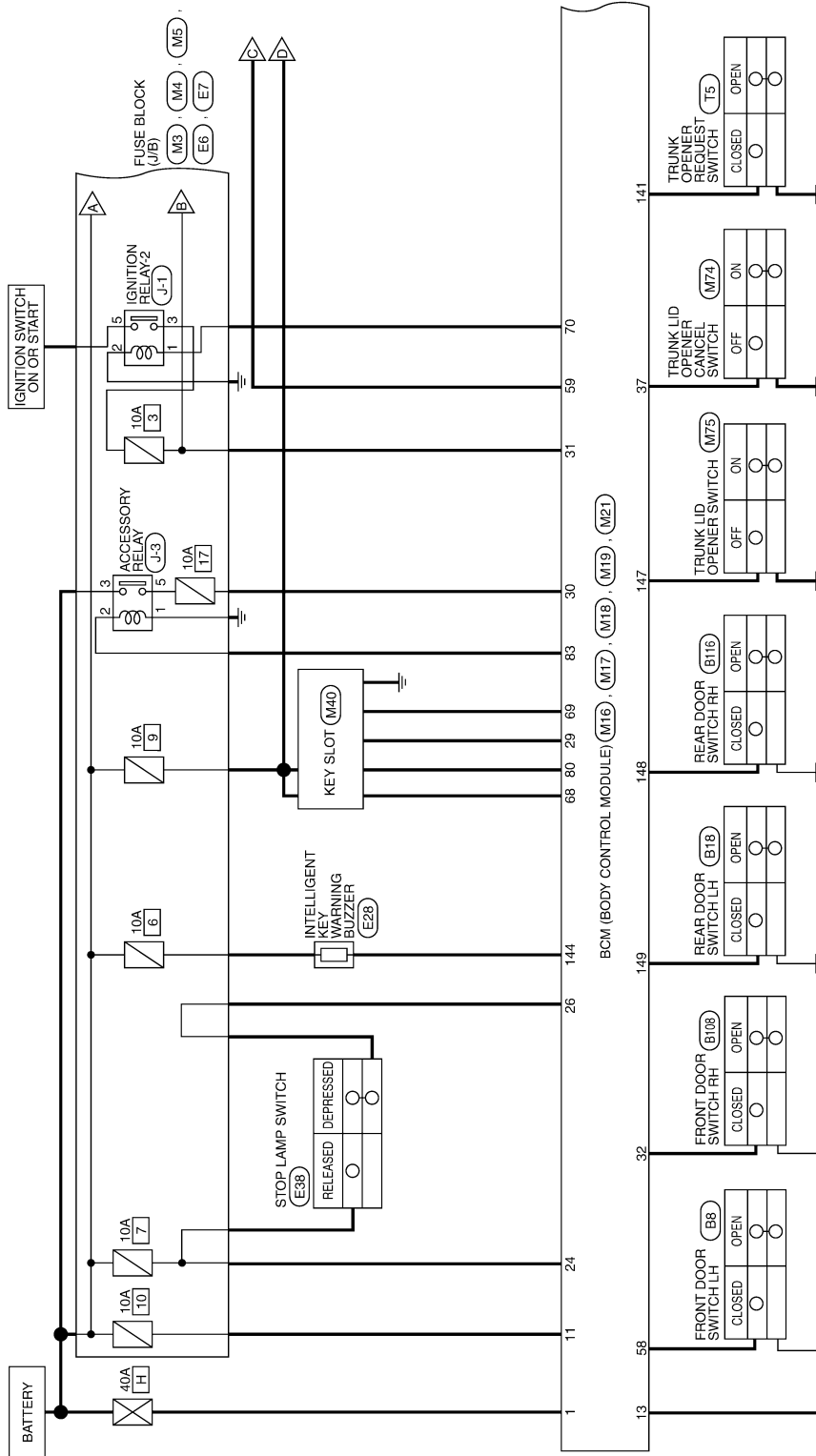

ABMWA0498GI

A  
B  
C  
D  
E  
F  
G  
H  
I  
J  
RF  
L  
M  
N  
O  
P

# BCM (BODY CONTROL MODULE)

[WITH SINGLE PANEL SUNROOF]

< ECU DIAGNOSIS >

- ◊TP◊ : WITH LOW TIRE PRESSURE MONITORING SYSTEM
- ◊EH◊ : WITH ELECTRONIC STEERING COLUMN LOCK
- ◊EJ◊ : WITHOUT ELECTRONIC STEERING COLUMN LOCK

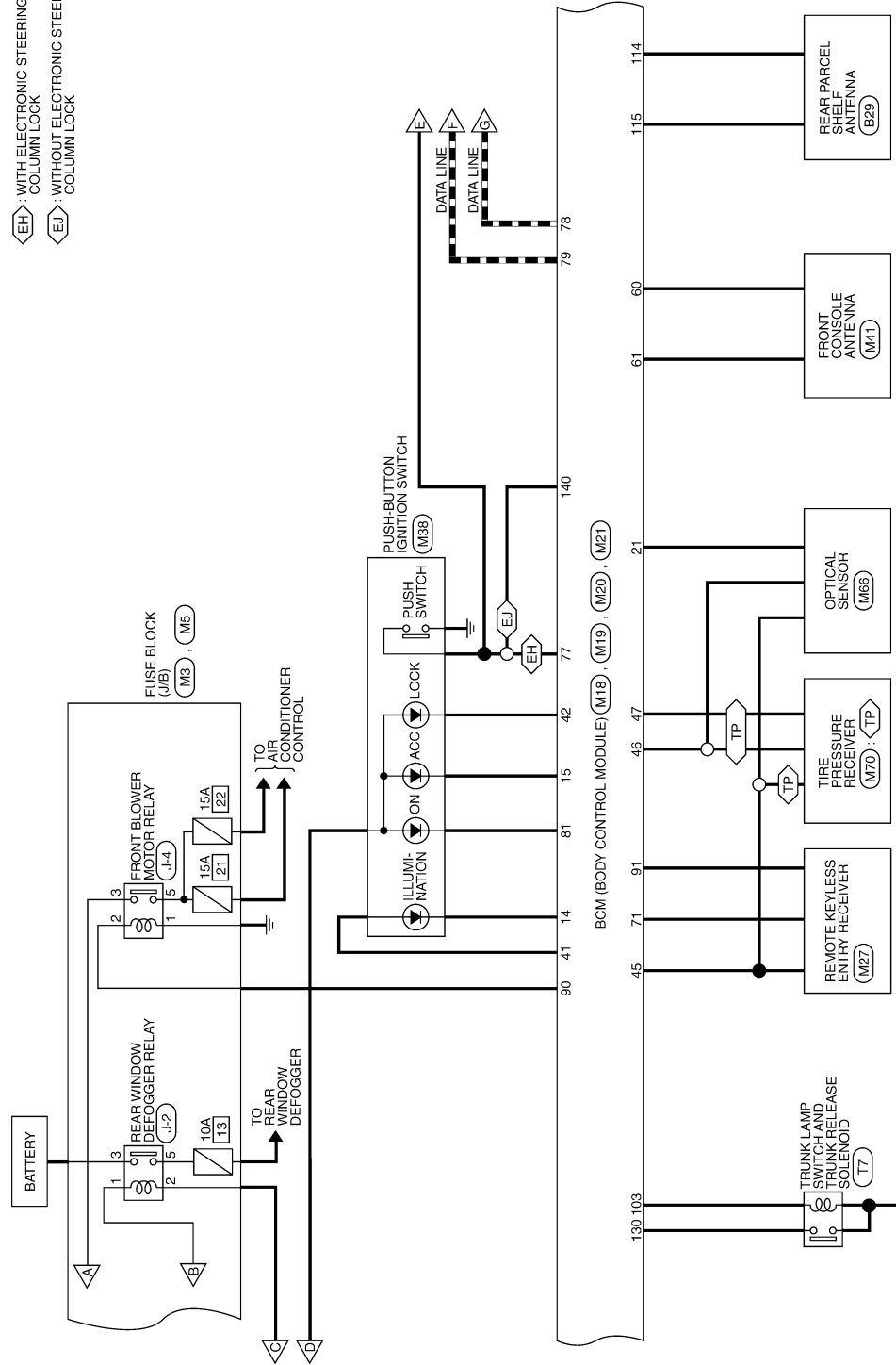

ABMWA0817GI

# BCM (BODY CONTROL MODULE)

< ECU DIAGNOSIS >

[WITH SINGLE PANEL SUNROOF]

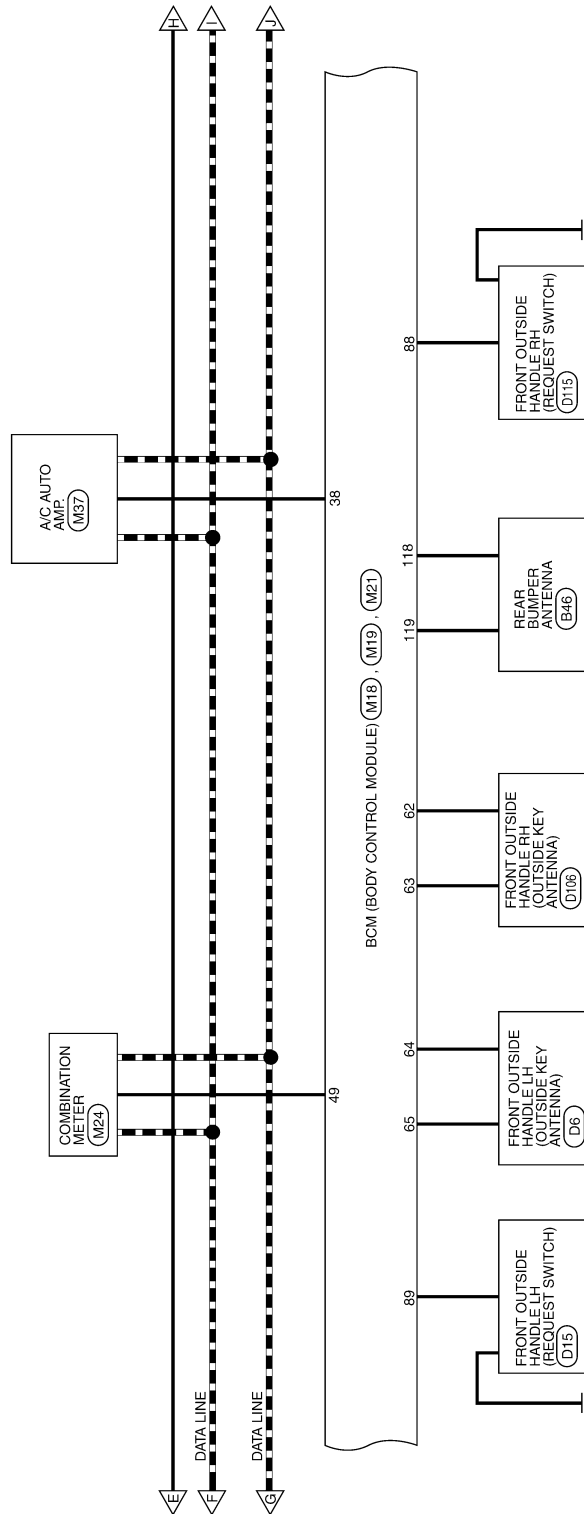

A  
B  
C  
D  
E  
F  
G  
H  
I  
J  
RF  
L  
M  
N  
O  
P

ABMWA0818GI

# BCM (BODY CONTROL MODULE)

< ECU DIAGNOSIS >

[WITH SINGLE PANEL SUNROOF]

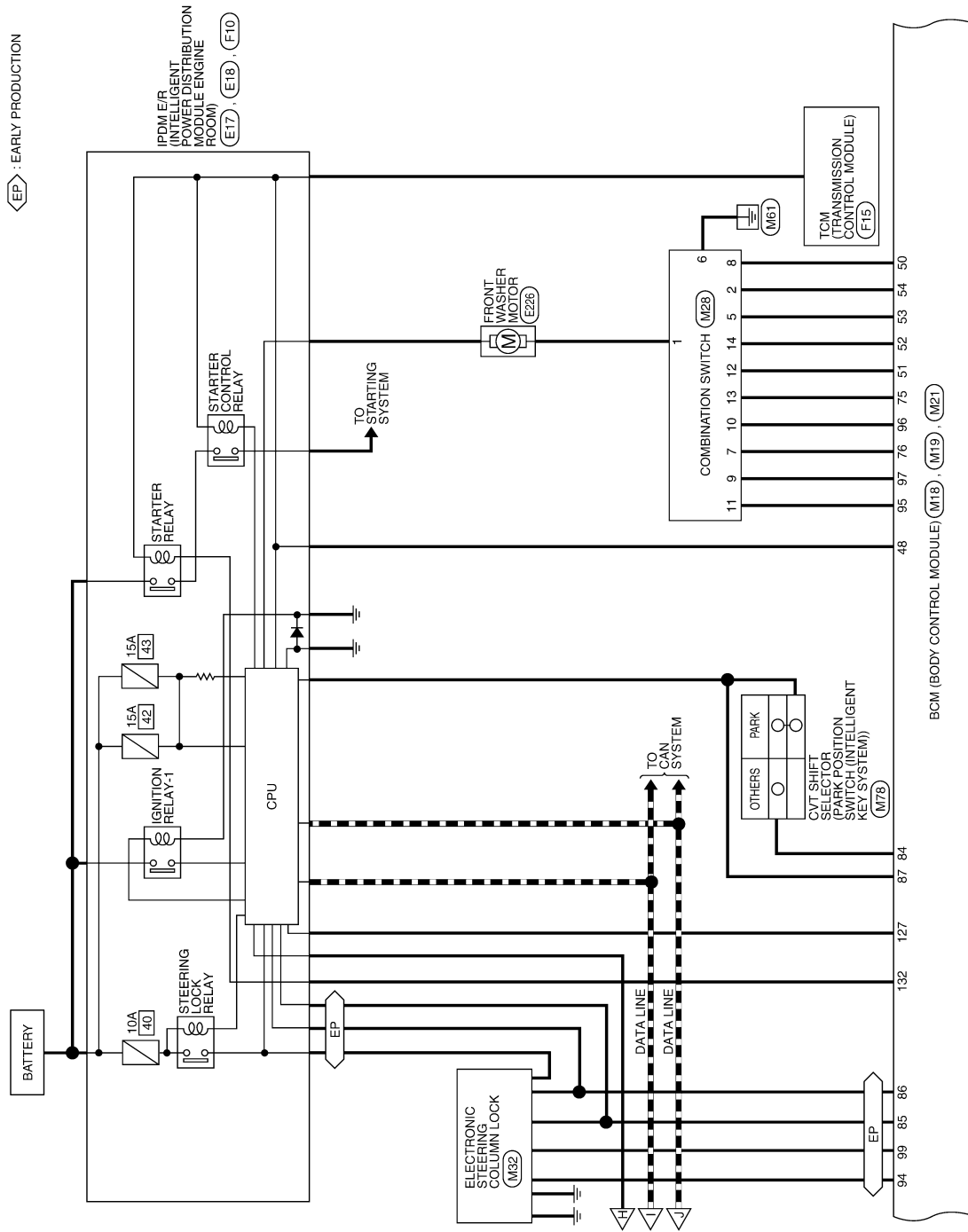

EP : EARLY PRODUCTION

ABMWA0819GI



# BCM (BODY CONTROL MODULE)

[WITH SINGLE PANEL SUNROOF]

< ECU DIAGNOSIS >

- $\langle A2 \rangle$  : WITH LEFT AND RIGHT FRONT POWER WINDOW ANTI-PINCH SYSTEM
- $\langle A3 \rangle$  : WITH FRONT AND REAR POWER WINDOW ANTI-PINCH SYSTEM
- $\langle DP \rangle$  : WITH DUAL PANEL SUNROOF
- $\langle DW \rangle$  : WITHOUT DUAL PANEL SUNROOF

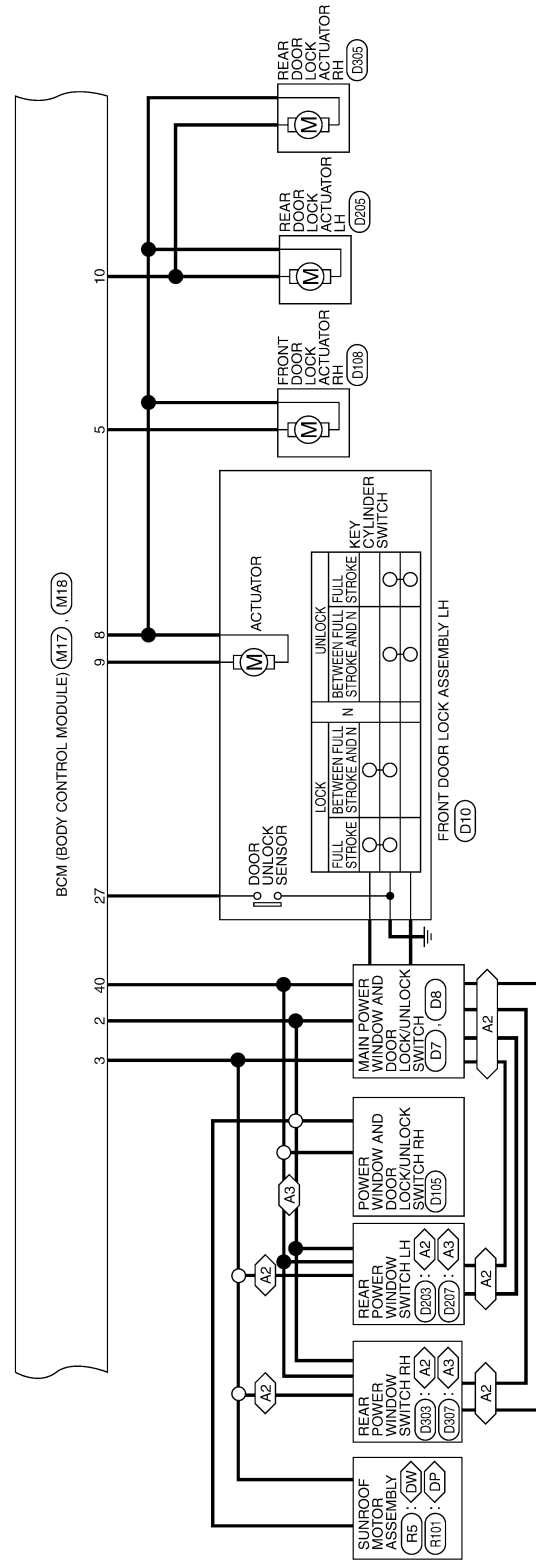

ABMWA0081GI

A  
B  
C  
D  
E  
F  
G  
H  
I  
J  
K  
L  
M  
N  
O  
P

RF

# BCM (BODY CONTROL MODULE)

< ECU DIAGNOSIS >

[WITH SINGLE PANEL SUNROOF]

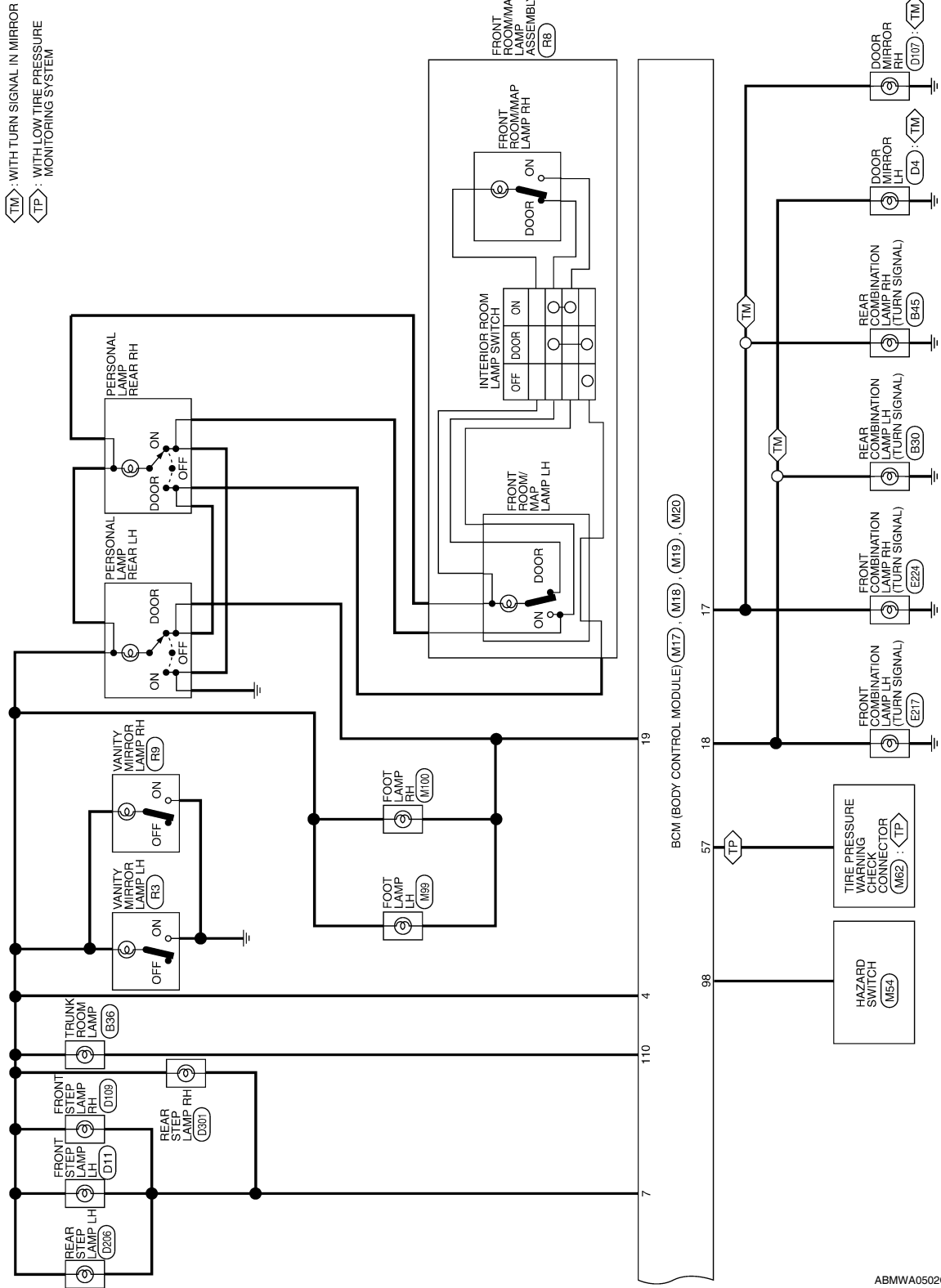

ABMWA0502GI

# BCM (BODY CONTROL MODULE)

[WITH SINGLE PANEL SUNROOF]

< ECU DIAGNOSIS >

## BCM (BODY CONTROL MODULE) CONNECTORS

Connector No.	M16
Connector Name	BCM (BODY CONTROL MODULE)
Connector Color	BLACK



Terminal No.	Color of Wire	Signal Name
1	W/B	BATT (F/L)
2	R/Y	P/W POWER SUPPLY PERM
3	L/W	P/W POWER SUPPLY IGN

Connector No.	M17
Connector Name	BCM (BODY CONTROL MODULE)
Connector Color	WHITE

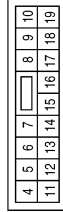

Terminal No.	Color of Wire	Signal Name
4	P/W	R/L POWER SUPPLY
5	G	DOOR UNLOCK OUTPUT AS
6	-	-
7	R/W	STEP LAMP CONT
8	V	DOOR LOCK OUTPUT ALL
9	L	DOOR UNLOCK OUTPUT (DR/FL)

Terminal No.	Color of Wire	Signal Name
10	G	DOOR UNLOCK OUTPUT (RR/RL)
11	Y/R	BAT BCM FUSE
12	-	-
13	B	GND1
14	GR/W	LOW SIDE PUSH LED
15	Y/L	ACC LED
16	-	-
17	G/B	FR FLASHER
18	G/Y	FL FLASHER
19	Y	ROOM LAMP CONT

Connector No.	M18
Connector Name	BCM (BODY CONTROL MODULE)
Connector Color	GREEN

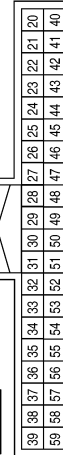

Terminal No.	Color of Wire	Signal Name
20	-	-
21	P/B	A/L SIGNAL TYPE 1
22	-	-
23	-	-
24	R/W	BRAKE SW1
25	-	-
26	O/L	BRAKE SW2

Terminal No.	Color of Wire	Signal Name
27	O	DOOR LOCK STATUS DR
28	-	-
29	Y	FOB IN SW 1
30	V/Y	ACC F/B
31	G	IGN F/B
32	R/B	AS DOOR SW 1
33	-	-
34	-	-
35	-	-
36	-	-
37	O	TRUNK CANCEL SW
38	GR/W	REAR DEFOGGER SW
39	-	-
40	Y/G	PW K-LINE
41	W	RING LED
42	R	S/L LOCK LED
43	-	-
44	-	-

Terminal No.	Color of Wire	Signal Name
45	P	GND RF2 A/L
46	V/W	A/L POWER SUPPLY 5V
47	G/O	RF2 TUNER SIGNAL
48	R/G	SHIFT N/P/NEUTRAL SW
49	L/O	IMMO LED (SECURITY INDICATOR)
50	LG/B	OUTPUT 5
51	L/W	OUTPUT 1
52	G/B	OUTPUT 2
53	LG/R	OUTPUT 3
54	G/Y	OUTPUT 4
55	-	-
56	-	-
57	W	TPMS MODE
58	SB	DR DOOR SW
59	G/R	REAR DEFOGGER

ABMIA1331GB

A B C D E F G H I J K L M N O P

RF

# BCM (BODY CONTROL MODULE)

[WITH SINGLE PANEL SUNROOF]

< ECU DIAGNOSIS >

Connector No.	M19
Connector Name	BCM (BODY CONTROL MODULE)
Connector Color	BLACK



79	78	77	76	75	74	73	72	71	70	69	68	67	66	65	64	63	62	61	60
59	58	57	56	55	54	53	52	51	50	49	48	47	46	45	44	43	42	41	40

Terminal No.	Color of Wire	Signal Name
60	B/R	ROOM ANT 2 B
61	W/R	ROOM ANT 2 A
62	V	AS DOOR ANT B
63	P	AS DOOR ANT A
64	V	DR DOOR ANT B
65	P	DR DOOR ANT A
66	-	-

Terminal No.	Color of Wire	Signal Name
67	-	-
68	G/O	FOB READER CLOCK
69	O	FOB READER DATA
70	R/B	IGN REL OUTPUT 2
71	L/O	RF1 TUNER SIGNAL
72	-	-
73	-	-
74	-	-
75	R/Y	INPUT 5
76	R/G	INPUT 3
77	BR	ENG START SW
78	P	CAN-L
79	L	CAN-H
80	R/L	FOB SLOT ILLUMINATION
81	LG	IGN ON LED
82	-	-
83	L	ACC CONT

Terminal No.	Color of Wire	Signal Name
84	Y/R	AT DEVICE OUT
85	L/O	S/L CONDITION 1
86	G/R	S/L CONDITION 2
87	G/B	SHIFT P/ASCD CANCEL SW
88	R	AS REQUEST SW
89	R	DR REQUEST SW
90	Y	BLOWER FAN RELAY
91	L/R	RF POWER SUPPLY 12V
92	-	-
93	-	-
94	G/Y	S/L POWER SUPPLY 12V
95	R/W	INPUT 1
96	P/B	INPUT 4
97	R/B	INPUT 2
98	G/O	HAZARD SW
99	L/Y	S/L K-LINE

Connector No.	M20
Connector Name	BCM (BODY CONTROL MODULE)
Connector Color	WHITE



100	101	102	103	104		
105	106	107	108	109	110	111

Terminal No.	Color of Wire	Signal Name
100	-	-
101	-	-
102	-	-
103	V	CDL BACK TRUNK

Terminal No.	Color of Wire	Signal Name
104	-	-
105	-	-
106	-	-
107	-	-
108	-	-
109	-	-
110	V/W	TRUNK LAMP CONT
111	-	-

ABMIA1332GB

# BCM (BODY CONTROL MODULE)

[WITH SINGLE PANEL SUNROOF]

< ECU DIAGNOSIS >

Terminal No.	Color of Wire	Signal Name
136	-	-
137	-	-
138	-	-
139	-	-
140	BR	ENG START SW W/O ESCL
141	BR	TRUNK REQUEST SW
142	-	-
143	-	-
144	GR	BUZZER
145	-	-
146	-	-
147	L/R	BACK TRUNK OPENER
148	R/W	RR DOOR SW
149	R/B	RL DOOR SW
150	-	-
151	-	-

Terminal No.	Color of Wire	Signal Name
119	BR/W	BACK DOOR ANT A
120	-	-
121	-	-
122	-	-
123	-	-
124	-	-
125	-	-
126	-	-
127	BR/W	IGN RELAY OUTPUT
128	-	-
129	-	-
130	W	TRUNK SW
131	-	-
132	R	ST RELAY OUTPUT
133	-	-
134	-	-
135	-	-

Terminal No.	Color of Wire	Signal Name
10	P/B	INPUT 4
11	R/W	INPUT 1
12	L/W	OUTPUT 1
13	R/Y	INPUT 5
14	G/B	OUTPUT 2

Connector No.	M21
Connector Name	BCM (BODY CONTROL MODULE)
Connector Color	GRAY

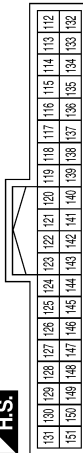

Terminal No.	Color of Wire	Signal Name
112	-	-
113	-	-
114	B	TRUNK ANT 1 B
115	W	TRUNK ANT 1 A
116	-	-
117	-	-
118	L/O	BACK DOOR ANT B

Connector No.	M28
Connector Name	COMBINATION SWITCH
Connector Color	WHITE

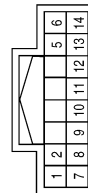

Terminal No.	Color of Wire	Signal Name
1	R/L	-
2	G/Y	OUTPUT 4
5	LG/R	OUTPUT 3
6	B	-
7	R/G	INPUT 3
8	LG/B	OUTPUT 5
9	R/B	INPUT 2

ABMIA2102GB

INFOID:000000005511863

## Fail Safe

Display contents of CONSULT	Fail-safe	Cancellation
B2013: ID DISCORD BCM-S/L*	Inhibit engine cranking	Erase DTC
B2014: CHAIN OF S/L-BCM*	Inhibit engine cranking	Erase DTC
B2190: NATS ANTENNA AMP	Inhibit engine cranking	Erase DTC

A  
B  
C  
D  
E  
F  
G  
H  
I  
J  
K  
L  
M  
N  
O  
P

RF

# BCM (BODY CONTROL MODULE)

< ECU DIAGNOSIS >

[WITH SINGLE PANEL SUNROOF]

Display contents of CONSULT	Fail-safe	Cancellation
B2191: DIFFERENCE OF KEY	Inhibit engine cranking	Erase DTC
B2192: ID DISCORD BCM-ECM	Inhibit engine cranking	Erase DTC
B2193: CHAIN OF BCM-ECM	Inhibit engine cranking	Erase DTC
B2195: ANTI-SCANNING	Inhibit engine cranking	Erase DTC
B2557: VEHICLE SPEED*	Inhibit electronic steering column lock	When normal vehicle speed signals have been received from ABS actuator and electric unit (control unit) for 500 ms
B2560: STARTER CONT RELAY	Inhibit engine cranking	500 ms after the following CAN signal communication status has become consistent <ul style="list-style-type: none"> <li>• Starter control relay signal</li> <li>• Starter relay status signal</li> </ul>
B2562: LO VOLTAGE	<ul style="list-style-type: none"> <li>• Inhibit engine cranking</li> <li>• Inhibit electronic steering column lock*</li> </ul>	100 ms after the power supply voltage increases to more than 8.8 V
B2601: SHIFT POSITION*	Inhibit electronic steering column lock	500 ms after the following signal reception status becomes consistent <ul style="list-style-type: none"> <li>• Selector lever P position switch signal</li> <li>• P range signal (CAN)</li> </ul>
B2602: SHIFT POSITION*	Inhibit electronic steering column lock	5 seconds after the following BCM recognition conditions are fulfilled <ul style="list-style-type: none"> <li>• Ignition switch is in the ON position</li> <li>• Selector lever P position switch signal: Except P position (battery voltage)</li> <li>• Vehicle speed: 4 km/h or more</li> </ul>
B2603: SHIFT POSI STATUS*	Inhibit electronic steering column lock	500 ms after the following BCM recognition conditions are fulfilled <ul style="list-style-type: none"> <li>• Ignition switch is in the ON position</li> <li>• Selector lever P position switch signal: Except P position (battery voltage)</li> <li>• Selector lever transmission range switch signal: Except P and N positions (0 V)</li> </ul>
B2604: TRANSMISSION RANGE SWITCH*	Inhibit electronic steering column lock	500 ms after any of the following BCM recognition conditions is fulfilled <ul style="list-style-type: none"> <li>• Status 1               <ul style="list-style-type: none"> <li>- Ignition switch is in the ON position</li> <li>- Selector lever transmission range switch signal: P and N position (battery voltage)</li> <li>- P range signal or N range signal (CAN): ON</li> </ul> </li> <li>• Status 2               <ul style="list-style-type: none"> <li>- Ignition switch is in the ON position</li> <li>- Selector lever transmission range switch signal: Except P and N positions (0 V)</li> <li>- P range signal and N range signal (CAN): OFF</li> </ul> </li> </ul>
B2605: TRANSMISSION RANGE SWITCH*	Inhibit electronic steering column lock	500 ms after any of the following BCM recognition conditions is fulfilled <ul style="list-style-type: none"> <li>• Ignition switch is in the ON position</li> <li>- Power position: IGN</li> <li>- Selector lever transmission range switch signal: Except P and N positions (0 V)</li> <li>- Transmission range switch signal (CAN): OFF</li> <li>• Status 2               <ul style="list-style-type: none"> <li>- Ignition switch is in the ON position</li> <li>- Selector lever transmission range switch signal: P or N position (battery voltage)</li> <li>- Transmission range switch signal (CAN): ON</li> </ul> </li> </ul>
B2606: S/L RELAY*	Inhibit engine cranking	500 ms after the following CAN signal communication status has become consistent <ul style="list-style-type: none"> <li>• Electronic steering column lock relay signal (Request signal)</li> <li>• Electronic steering column lock relay signal (Condition signal)</li> </ul>

# BCM (BODY CONTROL MODULE)

< ECU DIAGNOSIS >

[WITH SINGLE PANEL SUNROOF]

Display contents of CONSULT	Fail-safe	Cancellation
B2607: S/L RELAY*	Inhibit engine cranking	500 ms after the following CAN signal communication status has become consistent <ul style="list-style-type: none"> <li>Electronic steering column lock relay signal (Request signal)</li> <li>Electronic steering column lock relay signal (Condition signal)</li> </ul>
B2608: STARTER RELAY	Inhibit engine cranking	500 ms after the following signal communication status becomes consistent <ul style="list-style-type: none"> <li>Starter motor relay control signal</li> <li>Starter relay status signal (CAN)</li> </ul>
B2609: S/L STATUS*	<ul style="list-style-type: none"> <li>Inhibit engine cranking</li> <li>Inhibit electronic steering column lock</li> </ul>	When the following electronic steering column lock conditions agree <ul style="list-style-type: none"> <li>BCM electronic steering column lock control status</li> <li>Electronic steering column lock condition No. 1 signal status</li> <li>Electronic steering column lock condition No. 2 signal status</li> </ul>
B260A: IGNITION RELAY	Inhibit engine cranking	500 ms after the following conditions are fulfilled <ul style="list-style-type: none"> <li>IGN relay (IPDM E/R) control signal: OFF (Battery voltage)</li> <li>Ignition ON signal (CAN to IPDM E/R): OFF (Request signal)</li> <li>Ignition ON signal (CAN from IPDM E/R): OFF (Condition signal)</li> </ul>
B260F: ENG STATE SIG LOST	Maintains the power supply position attained at the time of DTC detection	When any of the following conditions is fulfilled <ul style="list-style-type: none"> <li>Power position changes to ACC</li> <li>Receives engine status signal (CAN)</li> </ul>
B2612: S/L STATUS*	<ul style="list-style-type: none"> <li>Inhibit engine cranking</li> <li>Inhibit electronic steering column lock</li> </ul>	When any of the following conditions is fulfilled <ul style="list-style-type: none"> <li>Electronic steering column lock unit status signal (CAN) is received normally</li> <li>The BCM electronic steering column lock control status matches the electronic steering column lock status recognized by the electronic steering column lock unit status signal (CAN from IPDM E/R)</li> </ul>
B2617: STARTER RELAY CIRC	Inhibit engine cranking	1 second after the starter motor relay control inside BCM becomes normal
B2618: BCM	Inhibit engine cranking	1 second after the ignition relay (IPDM E/R) control inside BCM becomes normal
B2619: BCM*	Inhibit engine cranking	1 second after the electronic steering column lock unit power supply output control inside BCM becomes normal
B26E1: ENG STATE NO RECIV	Inhibit engine cranking	When any of the following conditions are fulfilled <ul style="list-style-type: none"> <li>Power position changes to ACC</li> <li>Receives engine status signal (CAN)</li> </ul>

\* : With electronic steering column lock

## DTC Inspection Priority Chart

INFOID:000000005511864

If some DTCs are displayed at the same time, perform inspections one by one based on the following priority chart.

Priority	DTC
1	<ul style="list-style-type: none"> <li>B2562: LO VOLTAGE</li> </ul>
2	<ul style="list-style-type: none"> <li>U1000: CAN COMM CIRCUIT</li> <li>U1010: CONTROL UNIT (CAN)</li> </ul>
3	<ul style="list-style-type: none"> <li>B2190: NATS ANTENNA AMP</li> <li>B2191: DIFFERENCE OF KEY</li> <li>B2192: ID DISCORD BCM-ECM</li> <li>B2193: CHAIN OF BCM-ECM</li> </ul>

# BCM (BODY CONTROL MODULE)

< ECU DIAGNOSIS >

[WITH SINGLE PANEL SUNROOF]

Priority	DTC
4	<ul style="list-style-type: none"> <li>• B2013: ID DISCORD BCM-S/L*</li> <li>• B2014: CHAIN OF S/L-BCM*</li> <li>• B2553: IGNITION RELAY</li> <li>• B2555: STOP LAMP</li> <li>• B2556: PUSH-BTN IGN SW</li> <li>• B2557: VEHICLE SPEED</li> <li>• B2560: STARTER CONT RELAY</li> <li>• B2601: SHIFT POSITION</li> <li>• B2602: SHIFT POSITION</li> <li>• B2603: SHIFT POSI STATUS</li> <li>• B2604: TRANSMISSION RANGE SWITCH</li> <li>• B2605: TRANSMISSION RANGE SWITCH</li> <li>• B2606: S/L RELAY*</li> <li>• B2607: S/L RELAY*</li> <li>• B2608: STARTER RELAY</li> <li>• B2609: S/L STATUS*</li> <li>• B260A: IGNITION RELAY</li> <li>• B260B: STEERING LOCK UNIT*</li> <li>• B260C: STEERING LOCK UNIT*</li> <li>• B260D: STEERING LOCK UNIT*</li> <li>• B260F: ENG STATE SIG LOST</li> <li>• B2612: S/L STATUS*</li> <li>• B2614: ACC RELAY CIRC</li> <li>• B2615: BLOWER RELAY CIRC</li> <li>• B2616: IGN RELAY CIRC</li> <li>• B2617: STARTER RELAY CIRC</li> <li>• B2618: BCM</li> <li>• B2619: BCM*</li> <li>• B261A: PUSH-BTN IGN SW</li> <li>• B26E1: ENG STATE NO RECIV</li> <li>• C1729: VHCL SPEED SIG ERR</li> <li>• U0415: VEHICLE SPEED SIG</li> </ul>
5	<ul style="list-style-type: none"> <li>• C1704: LOW PRESSURE FL</li> <li>• C1705: LOW PRESSURE FR</li> <li>• C1706: LOW PRESSURE RR</li> <li>• C1707: LOW PRESSURE RL</li> <li>• C1708: [NO DATA] FL</li> <li>• C1709: [NO DATA] FR</li> <li>• C1710: [NO DATA] RR</li> <li>• C1711: [NO DATA] RL</li> <li>• C1712: [CHECKSUM ERR] FL</li> <li>• C1713: [CHECKSUM ERR] FR</li> <li>• C1714: [CHECKSUM ERR] RR</li> <li>• C1715: [CHECKSUM ERR] RL</li> <li>• C1716: [PRESSDATA ERR] FL</li> <li>• C1717: [PRESSDATA ERR] FR</li> <li>• C1718: [PRESSDATA ERR] RR</li> <li>• C1719: [PRESSDATA ERR] RL</li> <li>• C1720: [CODE ERR] FL</li> <li>• C1721: [CODE ERR] FR</li> <li>• C1722: [CODE ERR] RR</li> <li>• C1723: [CODE ERR] RL</li> <li>• C1724: [BATT VOLT LOW] FL</li> <li>• C1725: [BATT VOLT LOW] FR</li> <li>• C1726: [BATT VOLT LOW] RR</li> <li>• C1727: [BATT VOLT LOW] RL</li> <li>• C1734: CONTROL UNIT</li> </ul>
6	<ul style="list-style-type: none"> <li>• B2622: INSIDE ANTENNA</li> <li>• B2623: INSIDE ANTENNA</li> </ul>

\* : With electronic steering column lock



# BCM (BODY CONTROL MODULE)

[WITH SINGLE PANEL SUNROOF]

< ECU DIAGNOSIS >

## DTC Index

INFOID:000000005511865

### NOTE:

- Details of time display
- CRNT: Displays when there is a malfunction now or after returning to the normal condition until turning ignition switch OFF → ON again.
- 1 - 39: Displayed if any previous malfunction is present when current condition is normal. It increases 1 → 2 → 3...38 → 39 after returning to the normal condition whenever ignition switch OFF → ON. The counter remains at 39 even if the number of cycles exceeds it. It is counted from 1 again when turning ignition switch OFF → ON after returning to the normal condition if the malfunction is detected again.

CONSULT display	Fail-safe	Intelligent Key warning lamp ON	Tire pressure monitor warning lamp ON	Reference page
No DTC is detected. further testing may be required.	—	—	—	—
U1000: CAN COMM CIRCUIT	—	—	—	<a href="#">BCS-36</a>
U1010: CONTROL UNIT (CAN)	—	—	—	<a href="#">BCS-37</a>
U0415: VEHICLE SPEED SIG	—	—	—	<a href="#">BCS-38</a>
B2013: ID DISCORD BCM-S/L*	×	—	—	<a href="#">SEC-39</a>
B2014: CHAIN OF S/L-BCM*	×	—	—	<a href="#">SEC-40</a>
B2190: NATS ANTENNA AMP	×	—	—	<a href="#">SEC-43</a>
B2191: DIFFERENCE OF KEY	×	—	—	<a href="#">SEC-46</a>
B2192: ID DISCORD BCM-ECM	×	—	—	<a href="#">SEC-47</a>
B2193: CHAIN OF BCM-ECM	×	—	—	<a href="#">SEC-48</a>
B2553: IGNITION RELAY	—	—	—	<a href="#">PCS-55</a>
B2555: STOP LAMP	—	—	—	<a href="#">SEC-49</a>
B2556: PUSH-BTN IGN SW	—	×	—	<a href="#">SEC-52</a>
B2557: VEHICLE SPEED	×	×	—	<a href="#">SEC-54</a>
B2560: STARTER CONT RELAY	×	×	—	<a href="#">SEC-55</a>
B2562: LOW VOLTAGE	—	—	—	<a href="#">BCS-39</a>
B2601: SHIFT POSITION	×	×	—	<a href="#">SEC-56</a>
B2602: SHIFT POSITION	×	×	—	<a href="#">SEC-59</a>
B2603: SHIFT POSI STATUS	×	×	—	<a href="#">SEC-62</a>
B2604: TRANSMISSION RANGE SWITCH	×	×	—	<a href="#">SEC-65</a>
B2605: TRANSMISSION RANGE SWITCH	×	×	—	<a href="#">SEC-67</a>
B2606: S/L RELAY*	×	×	—	<a href="#">SEC-69</a>
B2607: S/L RELAY*	×	×	—	<a href="#">SEC-70</a>
B2608: STARTER RELAY	×	×	—	<a href="#">SEC-72</a>
B2609: S/L STATUS*	×	×	—	<a href="#">SEC-74</a>
B260A: IGNITION RELAY	×	×	—	<a href="#">PCS-57</a>
B260B: STEERING LOCK UNIT*	—	×	—	<a href="#">SEC-78</a>
B260C: STEERING LOCK UNIT*	—	×	—	<a href="#">SEC-79</a>
B260D: STEERING LOCK UNIT*	—	×	—	<a href="#">SEC-80</a>
B260F: ENG STATE SIG LOST	×	×	—	<a href="#">SEC-81</a>
B2612: S/L STATUS*	×	×	—	<a href="#">SEC-83</a>
B2614: ACC RELAY CIRC	—	×	—	<a href="#">PCS-59</a>

# BCM (BODY CONTROL MODULE)

< ECU DIAGNOSIS >

[WITH SINGLE PANEL SUNROOF]

CONSULT display	Fail-safe	Intelligent Key warning lamp ON	Tire pressure monitor warning lamp ON	Reference page
B2615: BLOWER RELAY CIRC	—	×	—	<a href="#">PCS-62</a>
B2616: IGN RELAY CIRC	—	×	—	<a href="#">PCS-65</a>
B2617: STARTER RELAY CIRC	×	×	—	<a href="#">PCS-65</a>
B2618: BCM	×	×	—	<a href="#">PCS-68</a>
B2619: BCM*	×	×	—	<a href="#">SEC-89</a>
B261A: PUSH-BTN IGN SW	—	×	—	<a href="#">SEC-90</a>
B2622: INSIDE ANTENNA	—	—	—	<a href="#">DLK-60</a>
B2623: INSIDE ANTENNA	—	—	—	<a href="#">DLK-63</a>
B26E1: ENG STATE NO RES	×	×	—	<a href="#">SEC-82</a>
C1704: LOW PRESSURE FL	—	—	×	<a href="#">WT-48</a>
C1705: LOW PRESSURE FR	—	—	×	<a href="#">WT-48</a>
C1706: LOW PRESSURE RR	—	—	×	<a href="#">WT-48</a>
C1707: LOW PRESSURE RL	—	—	×	<a href="#">WT-48</a>
C1708: [NO DATA] FL	—	—	×	<a href="#">WT-14</a>
C1709: [NO DATA] FR	—	—	×	<a href="#">WT-14</a>
C1710: [NO DATA] RR	—	—	×	<a href="#">WT-14</a>
C1711: [NO DATA] RL	—	—	×	<a href="#">WT-14</a>
C1712: [CHECKSUM ERR] FL	—	—	×	<a href="#">WT-16</a>
C1713: [CHECKSUM ERR] FR	—	—	×	<a href="#">WT-16</a>
C1714: [CHECKSUM ERR] RR	—	—	×	<a href="#">WT-16</a>
C1715: [CHECKSUM ERR] RL	—	—	×	<a href="#">WT-16</a>
C1716: [PRESSDATA ERR] FL	—	—	×	<a href="#">WT-18</a>
C1717: [PRESSDATA ERR] FR	—	—	×	<a href="#">WT-18</a>
C1718: [PRESSDATA ERR] RR	—	—	×	<a href="#">WT-18</a>
C1719: [PRESSDATA ERR] RL	—	—	×	<a href="#">WT-18</a>
C1720: [CODE ERR] FL	—	—	×	<a href="#">WT-16</a>
C1721: [CODE ERR] FR	—	—	×	<a href="#">WT-16</a>
C1722: [CODE ERR] RR	—	—	×	<a href="#">WT-16</a>
C1723: [CODE ERR] RL	—	—	×	<a href="#">WT-16</a>
C1724: [BATT VOLT LOW] FL	—	—	×	<a href="#">WT-16</a>
C1725: [BATT VOLT LOW] FR	—	—	×	<a href="#">WT-16</a>
C1726: [BATT VOLT LOW] RR	—	—	×	<a href="#">WT-16</a>
C1727: [BATT VOLT LOW] RL	—	—	×	<a href="#">WT-16</a>
C1729: VHCL SPEED SIG ERR	—	—	×	<a href="#">WT-20</a>
C1734: CONTROL UNIT	—	—	×	<a href="#">WT-21</a>

\* : With electronic steering column lock

# SUNROOF SYSTEM

[WITH SINGLE PANEL SUNROOF]

< ECU DIAGNOSIS >

## SUNROOF SYSTEM

Reference Value

INFOID:000000005461830

### TERMINAL LAYOUT

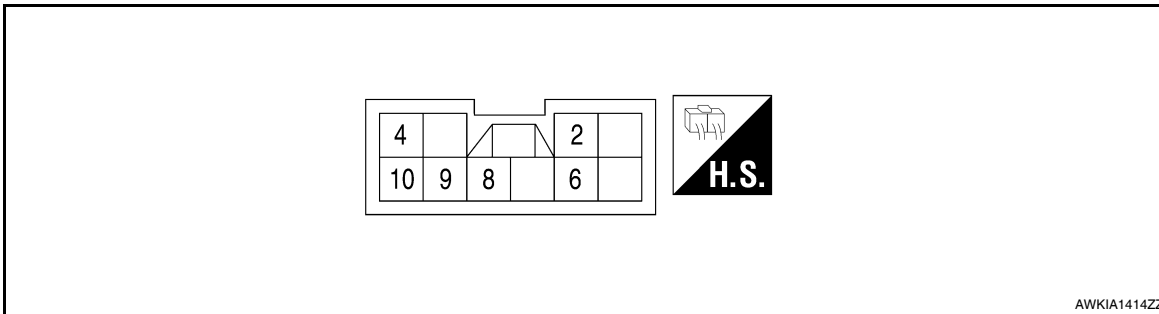

### PHYSICAL VALUES

Terminal No. (Wire color)		Description		Condition	Voltage (V)
+	-	Signal name	Input/ Output		
2 (LG)	Ground	Sunroof close switch (BIT 1) signal	Input	Sunroof switch in following position • TILT UP • SLIDE CLOSE	0
				Other than above	Battery voltage
4 (L/W)	Ground	RAP signal	Input	Ignition switch ON	Battery voltage
				Within 45 seconds after ignition switch is turned to OFF.	Battery voltage
				When driver side or passenger side door is opened during retained power operation.	0
6 (Y)	Ground	Sunroof open switch (BIT 0) signal	Input	Sunroof switch in following position • TILT DOWN • SLIDE OPEN	0
				Other than above	Battery voltage
8 (B)	Ground	Ground	—	—	0
9 (L/B)	Ground	Vehicle speed signal (2-pulse)	Input	Speedometer operated [When vehicle speed is approx.40km/h (25MPH)]	<p>ELF1080D</p>
10 (R/Y)	Ground	Sunroof power supply	Input	—	Battery voltage

# SUNROOF SYSTEM

[WITH SINGLE PANEL SUNROOF]

< ECU DIAGNOSIS >

## Wiring Diagram

INFOID:000000005461831

### SINGLE PANEL SUNROOF

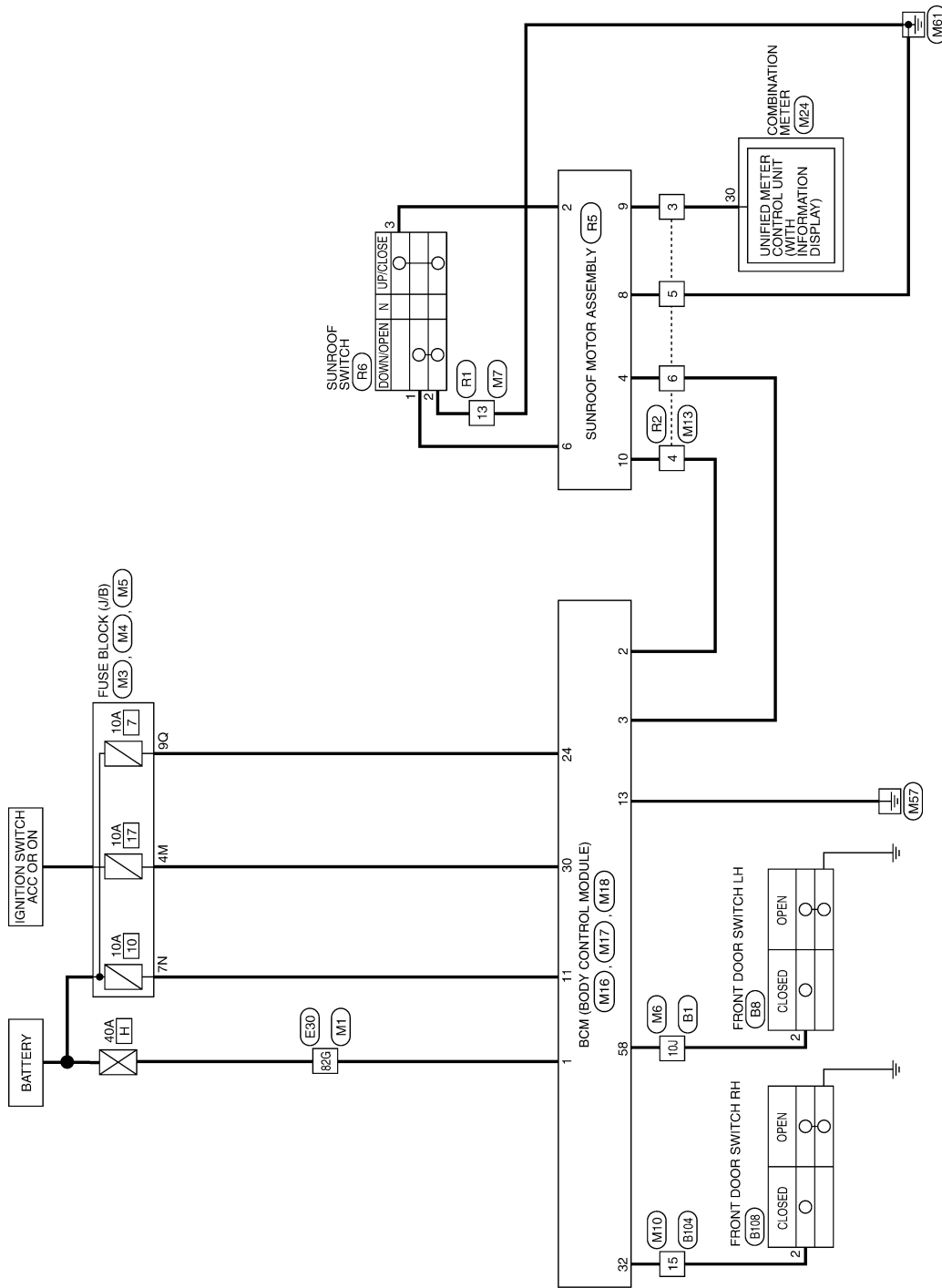

ABKWA0608GI

# SUNROOF SYSTEM

< ECU DIAGNOSIS >

[WITH SINGLE PANEL SUNROOF]

## SINGLE PANEL SUNROOF CONNECTORS

Connector No.	M1
Connector Name	WIRE TO WIRE
Connector Color	WHITE

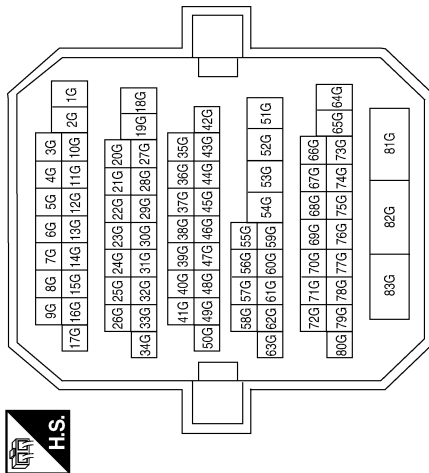

Terminal No.	82G	Color of Wire	W/B	Signal Name	-
--------------	-----	---------------	-----	-------------	---

Connector No.	M3
Connector Name	FUSE BLOCK (J/B)
Connector Color	WHITE

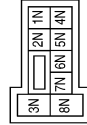

Terminal No.	7N	Color of Wire	Y/R	Signal Name	-
--------------	----	---------------	-----	-------------	---

Connector No.	M5
Connector Name	FUSE BLOCK (J/B)
Connector Color	WHITE

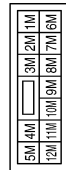

Terminal No.	4M	Color of Wire	V/Y	Signal Name	-
--------------	----	---------------	-----	-------------	---

Connector No.	M4
Connector Name	FUSE BLOCK (J/B)
Connector Color	WHITE

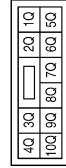

Terminal No.	9Q	Color of Wire	R/W	Signal Name	-
--------------	----	---------------	-----	-------------	---

A  
B  
C  
D  
E  
F  
G  
H  
I  
J  
RF  
L  
M  
N  
O  
P

# SUNROOF SYSTEM

< ECU DIAGNOSIS >

[WITH SINGLE PANEL SUNROOF]

Connector No.	M7
Connector Name	WIRE TO WIRE
Connector Color	WHITE

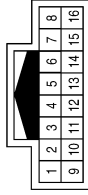

Terminal No.	13	Color of Wire	B	Signal Name	-
--------------	----	---------------	---	-------------	---

Terminal No.	10J	Color of Wire	SB	Signal Name	-
--------------	-----	---------------	----	-------------	---

Connector No.	M6
Connector Name	WIRE TO WIRE
Connector Color	WHITE

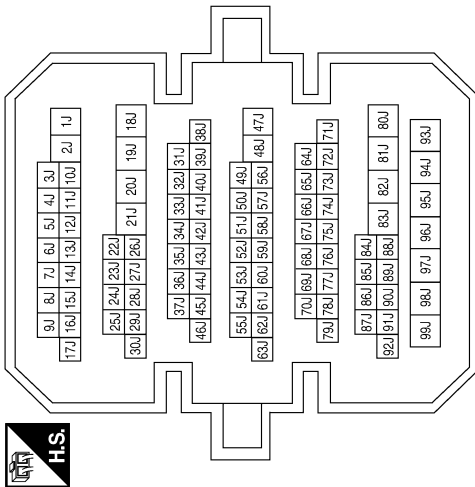

Connector No.	M16
Connector Name	BCM (BODY CONTROL MODULE)
Connector Color	BLACK



Terminal No.	1	Color of Wire	W/B	Signal Name	BATT (F/L)
2	R/Y	P/W POWER SUPPLY PERM			
3	L/W	P/W POWER SUPPLY IGN			

Connector No.	M13
Connector Name	WIRE TO WIRE
Connector Color	WHITE

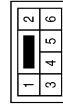

Terminal No.	3	Color of Wire	L/B	Signal Name	-
4	R/Y	-			
5	B	-			
6	L/W	-			

Connector No.	M10
Connector Name	WIRE TO WIRE
Connector Color	WHITE

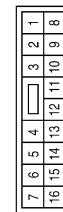

Terminal No.	15	Color of Wire	R/B	Signal Name	-
--------------	----	---------------	-----	-------------	---

# SUNROOF SYSTEM

[WITH SINGLE PANEL SUNROOF]

< ECU DIAGNOSIS >

Connector No.	M17
Connector Name	BCM (BODY CONTROL MODULE)
Connector Color	WHITE

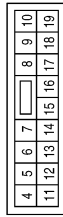

Terminal No.	Color of Wire	Signal Name
11	Y/R	BAT BCM FUSE
13	B	GND1

Connector No.	M18
Connector Name	BCM (BODY CONTROL MODULE)
Connector Color	GREEN

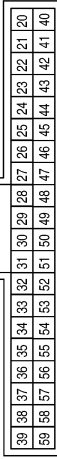

Terminal No.	Color of Wire	Signal Name
24	R/W	BRAKE SW 1
30	V/Y	ACC F/B
32	R/B	AS DOOR SW 1
58	SB	DR DOOR SW

Connector No.	M24
Connector Name	COMBINATION METER
Connector Color	WHITE

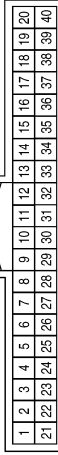

Terminal No.	Color of Wire	Signal Name
30	L/B	2P/R OUT

Connector No.	E30
Connector Name	WIRE TO WIRE
Connector Color	WHITE

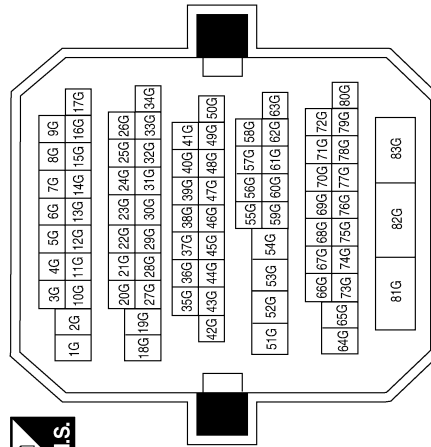

Terminal No.	Color of Wire	Signal Name
82G	LG	-

A  
B  
C  
D  
E  
F  
G  
H  
I  
J  
RF  
L  
M  
N  
O  
P

# SUNROOF SYSTEM

< ECU DIAGNOSIS >

[WITH SINGLE PANEL SUNROOF]

Connector No.	B8
Connector Name	FRONT DOOR SWITCH LH
Connector Color	WHITE

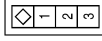

Terminal No.	2	Color of Wire	SB	Signal Name	-
--------------	---	---------------	----	-------------	---

Terminal No.	10J	Color of Wire	SB	Signal Name	-
--------------	-----	---------------	----	-------------	---

Connector No.	B1
Connector Name	WIRE TO WIRE
Connector Color	WHITE

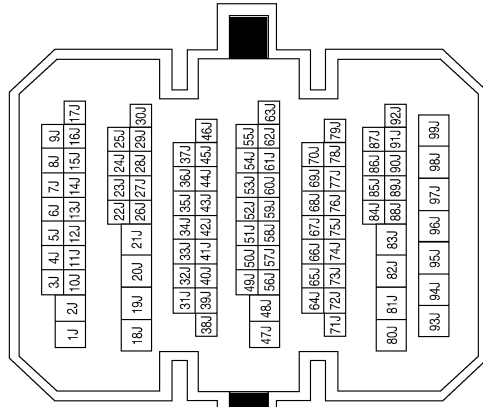

Connector No.	R1
Connector Name	WIRE TO WIRE
Connector Color	WHITE

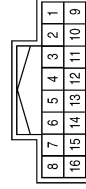

Terminal No.	13	Color of Wire	B	Signal Name	-
--------------	----	---------------	---	-------------	---

Connector No.	B108
Connector Name	FRONT DOOR SWITCH RH
Connector Color	WHITE



Terminal No.	2	Color of Wire	GR	Signal Name	-
--------------	---	---------------	----	-------------	---

Connector No.	B104
Connector Name	WIRE TO WIRE
Connector Color	WHITE

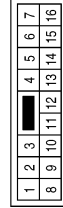

Terminal No.	15	Color of Wire	GR	Signal Name	-
--------------	----	---------------	----	-------------	---

ABKIA0422GB



# SUNROOF SYSTEM

< ECU DIAGNOSIS >

[WITH SINGLE PANEL SUNROOF]

Connector No.	R6
Connector Name	SUNROOF SWITCH (WITHOUT DUAL PANEL SUNROOF)
Connector Color	WHITE



Terminal No.	Color of Wire	Signal Name
1	Y	+DOWN OPEN
2	B	GND
3	LG	+UP CLOSE

Connector No.	R5
Connector Name	SUNROOF MOTOR ASSEMBLY (WITHOUT DUAL PANEL SUNROOF)
Connector Color	WHITE

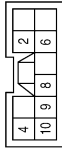

Terminal No.	Color of Wire	Signal Name
2	LG	CLOSE/TILT-UP SW
4	L/W	+IGN
6	Y	OPEN/TILT-DOWN SW
8	B	GND
9	L/B	SPEED SENSOR (2P)
10	R/Y	+B

Connector No.	R2
Connector Name	WIRE TO WIRE
Connector Color	WHITE



Terminal No.	Color of Wire	Signal Name
3	L/B	-
4	R/Y	-
5	B	-
6	L/W	-

A  
B  
C  
D  
E  
F  
G  
H  
I  
J  
RF  
L  
M  
N  
O  
P

ABKIA1785GB

# SUNROOF DOES NOT OPERATE PROPERLY

< SYMPTOM DIAGNOSIS >

[WITH SINGLE PANEL SUNROOF]

## SYMPTOM DIAGNOSIS

### SUNROOF DOES NOT OPERATE PROPERLY

#### Diagnosis Procedure

INFOID:000000005461832

#### 1. CHECK BCM POWER SUPPLY AND GROUND CIRCUIT

---

Check BCM power supply and ground circuit.  
Refer to [BCS-40, "Diagnosis Procedure"](#).

>> GO TO 2

#### 2. CHECK SUNROOF MOTOR ASSEMBLY POWER SUPPLY AND GROUND CIRCUIT

---

Check sunroof motor assembly power supply and ground circuit.  
Refer to [RF-14, "SUNROOF MOTOR ASSEMBLY : Component Function Check"](#).

>> Check intermittent incident. Refer to [GI-39, "Intermittent Incident"](#).

# AUTO OPERATION DOES NOT OPERATE

< SYMPTOM DIAGNOSIS >

[WITH SINGLE PANEL SUNROOF]

## AUTO OPERATION DOES NOT OPERATE

### Diagnosis Procedure

INFOID:000000005461833

#### 1. PERFORM INITIALIZATION PROCEDURE

Perform initialization procedure.

Refer to [RF-7, "ADDITIONAL SERVICE WHEN REPLACING CONTROL UNIT : Special Repair Requirement"](#).

Is the inspection result normal?

>> Check intermittent incident. Refer to [GI-39, "Intermittent Incident"](#).

A  
B  
C  
D  
E  
F  
G  
H  
I  
J  
RF  
L  
M  
N  
O  
P

## DOES NOT STOP FULLY-OPEN OR FULLY-CLOSED POSITION

< SYMPTOM DIAGNOSIS >

[WITH SINGLE PANEL SUNROOF]

---

## DOES NOT STOP FULLY-OPEN OR FULLY-CLOSED POSITION

### Diagnosis Procedure

INFOID:000000005461834

#### 1. PERFORM INITIALIZATION PROCEDURE

---

Perform initialization procedure.

Refer to [RF-7, "ADDITIONAL SERVICE WHEN REPLACING CONTROL UNIT : Special Repair Requirement"](#).

Is the inspection result normal?

>> Check intermittent incident. Refer to [GI-39, "Intermittent Incident"](#).

# RETAINED POWER OPERATION DOES NOT OPERATE PROPERLY

< SYMPTOM DIAGNOSIS >

[WITH SINGLE PANEL SUNROOF]

## RETAINED POWER OPERATION DOES NOT OPERATE PROPERLY

### Diagnosis Procedure

INFOID:000000005461835

#### 1. CHECK FRONT DOOR SWITCH

Check front door switch.

Refer to [DLK-68, "Component Function Check"](#).

Is the inspection result normal?

>> Check intermittent incident. Refer to [GI-39, "Intermittent Incident"](#).

A  
B  
C  
D  
E  
F  
G  
H  
I  
J  
RF  
L  
M  
N  
O  
P

## SUNROOF DOES NOT OPERATE ANTI-PINCH FUNCTION

< SYMPTOM DIAGNOSIS >

[WITH SINGLE PANEL SUNROOF]

---

## SUNROOF DOES NOT OPERATE ANTI-PINCH FUNCTION

### Diagnosis Procedure

INFOID:000000005461836

#### 1. PERFORM INITIALIZATION PROCEDURE

---

Perform initialization procedure.

Refer to [RF-7, "ADDITIONAL SERVICE WHEN REPLACING CONTROL UNIT : Special Repair Requirement"](#).

Is the inspection result normal?

>> Check intermittent incident. Refer to [GI-39, "Intermittent Incident"](#).

# SQUEAK AND RATTLE TROUBLE DIAGNOSES

< SYMPTOM DIAGNOSIS >

[WITH SINGLE PANEL SUNROOF]

## SQUEAK AND RATTLE TROUBLE DIAGNOSES

### Work Flow

INFOID:000000005485376

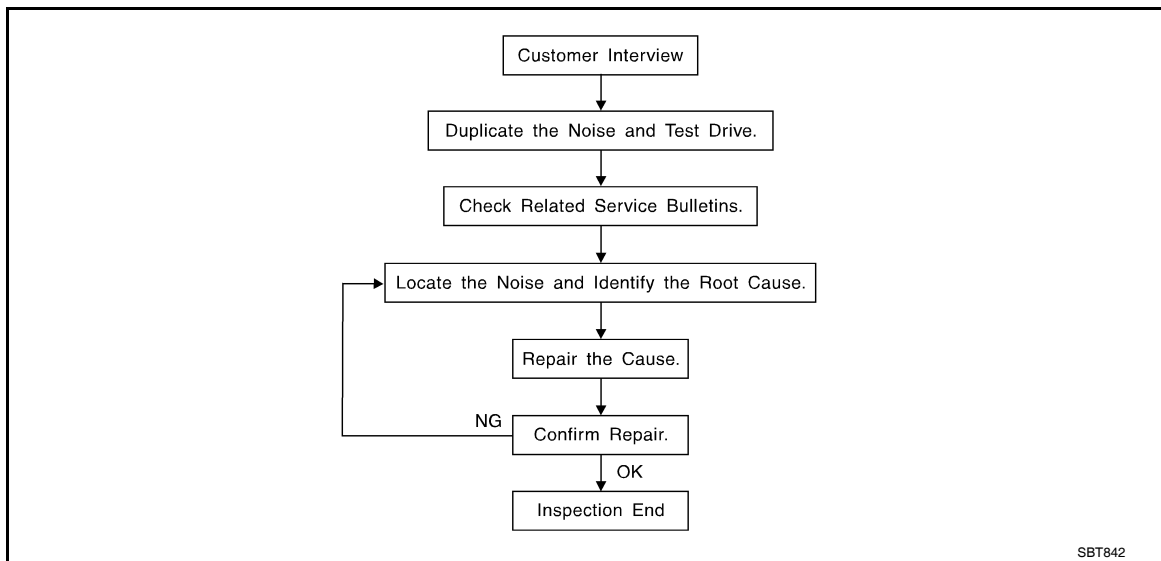

### CUSTOMER INTERVIEW

Interview the customer if possible, to determine the conditions that exist when the noise occurs. Use the Diagnostic Worksheet during the interview to document the facts and conditions when the noise occurs and any customer's comments; refer to [IP-6, "Diagnostic Worksheet"](#). This information is necessary to duplicate the conditions that exist when the noise occurs.

- The customer may not be able to provide a detailed descriptions or the location of the noise. Attempt to obtain all the facts and conditions that exist when the noise occurs (or does not occur).
- If there is more than one noise in the vehicle, be sure to diagnose and repair the noise that the customer is concerned about. This can be accomplished by test driving the vehicle with the customer.
- After identifying the type of noise, isolate the noise in terms of its characteristics. The noise characteristics are provided so the customer, service adviser and technician are all speaking the same language when defining the noise.
- Squeak —(Like tennis shoes on a clean floor)  
Squeak characteristics include the light contact/fast movement/brought on by road conditions/hard surfaces = higher pitch noise/softer surfaces = lower pitch noises/edge to surface = chirping
- Creak—(Like walking on an old wooden floor)  
Creak characteristics include firm contact/slow movement/twisting with a rotational movement/pitch dependent on materials/often brought on by activity.
- Rattle—(Like shaking a baby rattle)  
Rattle characteristics include the fast repeated contact/vibration or similar movement/loose parts/missing clip or fastener/incorrect clearance.
- Knock —(Like a knock on a door)  
Knock characteristics include hollow sounding/sometimes repeating/often brought on by driver action.
- Tick—(Like a clock second hand)  
Tick characteristics include gentle contacting of light materials/loose components/can be caused by driver action or road conditions.
- Thump—(Heavy, muffled knock noise)  
Thump characteristics include softer knock/dead sound often brought on by activity.
- Buzz—(Like a bumble bee)  
Buzz characteristics include high frequency rattle/firm contact.
- Often the degree of acceptable noise level will vary depending upon the person. A noise that you may judge as acceptable may be very irritating to the customer.
- Weather conditions, especially humidity and temperature, may have a great effect on noise level.

### DUPLICATE THE NOISE AND TEST DRIVE

If possible, drive the vehicle with the customer until the noise is duplicated. Note any additional information on the Diagnostic Worksheet regarding the conditions or location of the noise. This information can be used to duplicate the same conditions when you confirm the repair.

# SQUEAK AND RATTLE TROUBLE DIAGNOSES

[WITH SINGLE PANEL SUNROOF]

## < SYMPTOM DIAGNOSIS >

If the noise can be duplicated easily during the test drive, to help identify the source of the noise, try to duplicate the noise with the vehicle stopped by doing one or all of the following:

- 1) Close a door.
  - 2) Tap or push/pull around the area where the noise appears to be coming from.
  - 3) Rev the engine.
  - 4) Use a floor jack to recreate vehicle "twist".
  - 5) At idle, apply engine load (with brakes applied, place CVT shift selector in drive position).
  - 6) Raise the vehicle on a hoist and hit a tire with a rubber hammer.
- Drive the vehicle and attempt to duplicate the conditions the customer states exist when the noise occurs.
  - If it is difficult to duplicate the noise, drive the vehicle slowly on an undulating or rough road to stress the vehicle body.

## CHECK RELATED SERVICE BULLETINS

After verifying the customer concern or symptom, check ASIST for Technical Service Bulletins (TSBs) related to that concern or symptom.

If a TSB relates to the symptom, follow the procedure to repair the noise.

## LOCATE THE NOISE AND IDENTIFY THE ROOT CAUSE

1. Narrow down the noise to a general area. To help pinpoint the source of the noise, use a listening tool (Chassis Ear: J-39570, Engine Ear and mechanics stethoscope).
2. Narrow down the noise to a more specific area and identify the cause of the noise by:
  - removing the components in the area that you suspect the noise is coming from.  
Do not use too much force when removing clips and fasteners, otherwise clips and fastener can be broken or lost during the repair, resulting in the creation of new noise.
  - tapping or pushing/pulling the component that you suspect is causing the noise.  
Do not tap or push/pull the component with excessive force, otherwise the noise will be eliminated only temporarily.
  - feeling for a vibration with your hand by touching the component(s) that you suspect is (are) causing the noise.
  - placing a piece of paper between components that you suspect are causing the noise.
  - looking for loose components and contact marks.  
Refer to [RF-73. "Generic Squeak and Rattle Troubleshooting"](#).

## REPAIR THE CAUSE

- If the cause is a loose component, tighten the component securely.
- If the cause is insufficient clearance between components:
  - separate components by repositioning or loosening and retightening the component, if possible.
  - insulate components with a suitable insulator such as urethane pads, foam blocks, felt cloth tape or urethane tape. A Nissan Squeak and Rattle Kit (J-43980) is available through your authorized Nissan Parts Department.

### **CAUTION:**

**Do not use excessive force as many components are constructed of plastic and may be damaged.**

### **NOTE:**

Always check with the Parts Department for the latest parts information.

The following materials are contained in the Nissan Squeak and Rattle Kit (J-43980). Each item can be ordered separately as needed.

URETHANE PADS [1.5 mm (0.059 in) thick]

Insulates connectors, harness, etc.

76268-9E005: 100 × 135 mm (3.94 × 5.31 in)/76884-71L01: 60 × 85 mm (2.36 × 3.35 in)/76884-71L02: 15 × 25 mm (0.59 × 0.98 in)

INSULATOR (Foam blocks)

Insulates components from contact. Can be used to fill space behind a panel.

73982-9E000: 45 mm (1.77 in) thick, 50 × 50 mm (1.97 × 1.97 in)/73982-

50Y00: 10 mm (0.39 in) thick, 50 × 50 mm (1.97 × 1.97 in)

INSULATOR (Light foam block)

80845-71L00: 30 mm (1.18 in) thick, 30 × 50 mm (1.18 × 1.97in)

FELT CLOTH TAPE

Used to insulate where movement does not occur. Ideal for instrument panel applications.

68370-4B000: 15 × 25 mm (0.59 × 0.98 in) pad/68239-13E00: 5 mm (0.20 in) wide tape roll

The following materials, not found in the kit, can also be used to repair squeaks and rattles.

UHMW (TEFLON) TAPE



# SQUEAK AND RATTLE TROUBLE DIAGNOSES

[WITH SINGLE PANEL SUNROOF]

## < SYMPTOM DIAGNOSIS >

Insulates where slight movement is present. Ideal for instrument panel applications.

### SILICONE GREASE

Used in place of UHMW tape that will be visible or not fit. Will only last a few months.

### SILICONE SPRAY

Use when grease cannot be applied.

### DUCT TAPE

Use to eliminate movement.

## CONFIRM THE REPAIR

Confirm that the cause of a noise is repaired by test driving the vehicle. Operate the vehicle under the same conditions as when the noise originally occurred. Refer to the notes on the Diagnostic Worksheet.

## Generic Squeak and Rattle Troubleshooting

INFOID:000000005485377

Refer to Table of Contents for specific component removal and installation information.

## INSTRUMENT PANEL

Most incidents are caused by contact and movement between:

1. Acrylic lens and combination meter housing
2. Instrument panel to front pillar finishers
3. Instrument panel to windshield
4. Instrument panel mounting pins
5. Wiring harnesses behind the combination meter
6. A/C defroster duct and duct joint

These incidents can usually be located by tapping or moving the components to duplicate the noise or by pressing on the components while driving to stop the noise. Most of these incidents can be repaired by applying felt cloth tape or silicone spray (in hard to reach areas). Urethane pads can be used to insulate wiring harness.

### **CAUTION:**

**Do not use silicone spray to isolate a squeak or rattle. If you saturate the area with silicone, you will not be able to recheck the repair.**

## CENTER CONSOLE

Components to pay attention to include:

1. Shifter assembly cover to finisher
2. A/C control unit and cluster lid C
3. Wiring harnesses behind audio and A/C control unit

The instrument panel repair and isolation procedures also apply to the center console.

## DOORS

Pay attention to the:

1. Finisher and inner panel making a slapping noise
2. Inside handle escutcheon to door finisher
3. Wiring harnesses tapping
4. Door striker out of alignment causing a popping noise on starts and stops

Tapping or moving the components or pressing on them while driving to duplicate the conditions can isolate many of these incidents. You can usually insulate the areas with felt cloth tape or insulator foam blocks from the Nissan Squeak and Rattle Kit (J-43980) to repair the noise.

## TRUNK

Trunk noises are often caused by a loose jack or loose items put into the trunk by the owner.

In addition look for:

1. Trunk lid bumpers out of adjustment
2. Trunk lid striker out of adjustment
3. The trunk lid torsion bars knocking together
4. A loose license plate or bracket

Most of these incidents can be repaired by adjusting, securing or insulating the item(s) or component(s) causing the noise.

A  
B  
C  
D  
E  
F  
G  
H  
I  
J  
L  
M  
N  
O  
P

RF

# SQUEAK AND RATTLE TROUBLE DIAGNOSES

[WITH SINGLE PANEL SUNROOF]

< SYMPTOM DIAGNOSIS >

## SUNROOF/HEADLINING

Noises in the sunroof/headlining area can often be traced to one of the following:

1. Sunroof lid, rail, linkage or seals making a rattle or light knocking noise
2. Sunvisor shaft shaking in the holder
3. Front or rear windshield touching headlining and squeaking

Again, pressing on the components to stop the noise while duplicating the conditions can isolate most of these incidents. Repairs usually consist of insulating with felt cloth tape.

## OVERHEAD CONSOLE (FRONT AND REAR)

Overhead console noises are often caused by the console panel clips not being engaged correctly. Most of these incidents are repaired by pushing up on the console at the clip locations until the clips engage.

In addition, look for:

1. Loose harness or harness connectors.
2. Front console map/reading lamp lens loose.
3. Loose screws at console attachment points.

## SEATS

When isolating seat noise it's important to note the position the seat is in and the load placed on the seat when the noise is present. These conditions should be duplicated when verifying and isolating the cause of the noise.

Cause of seat noise include:

1. Headrest rods and holder
2. A squeak between the seat pad cushion and frame
3. The rear seatback lock and bracket

These noises can be isolated by moving or pressing on the suspected components while duplicating the conditions under which the noise occurs. Most of these incidents can be repaired by repositioning the component or applying urethane tape to the contact area.

## UNDERHOOD

Some interior noise may be caused by components under the hood or on the engine wall. The noise is then transmitted into the passenger compartment.

Causes of transmitted underhood noise include:

1. Any component mounted to the engine wall
2. Components that pass through the engine wall
3. Engine wall mounts and connectors
4. Loose radiator mounting pins
5. Hood bumpers out of adjustment
6. Hood striker out of adjustment

These noises can be difficult to isolate since they cannot be reached from the interior of the vehicle. The best method is to secure, move or insulate one component at a time and test drive the vehicle. Also, engine RPM or load can be changed to isolate the noise. Repairs can usually be made by moving, adjusting, securing, or insulating the component causing the noise.

# SQUEAK AND RATTLE TROUBLE DIAGNOSES

[WITH SINGLE PANEL SUNROOF]

< SYMPTOM DIAGNOSIS >

## Diagnostic Worksheet

INFOID:000000005461839

Dear Customer:

We are concerned about your satisfaction with your vehicle. Repairing a squeak or rattle sometimes can be very difficult. To help us fix your vehicle right the first time, please take a moment to note the area of the vehicle where the squeak or rattle occurs and under what conditions. You may be asked to take a test drive with a service advisor or technician to ensure we confirm the noise you are hearing.

### SQUEAK & RATTLE DIAGNOSTIC WORKSHEET

#### I. WHERE DOES THE NOISE COME FROM? (circle the area of the vehicle)

The illustrations are for reference only, and may not reflect the actual configuration of your vehicle.

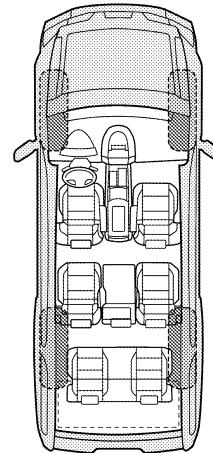
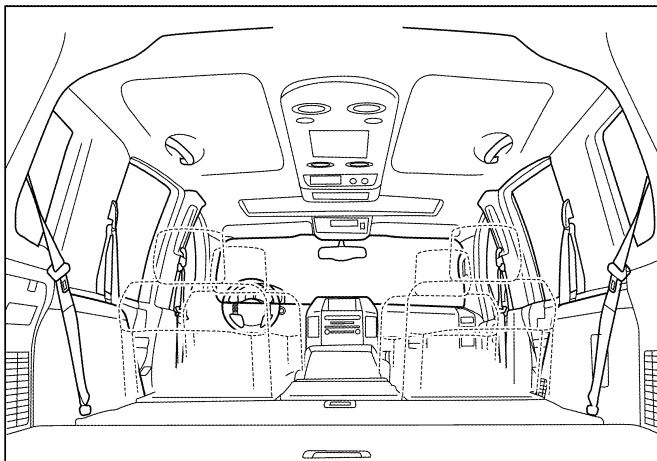
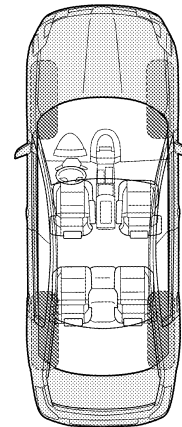
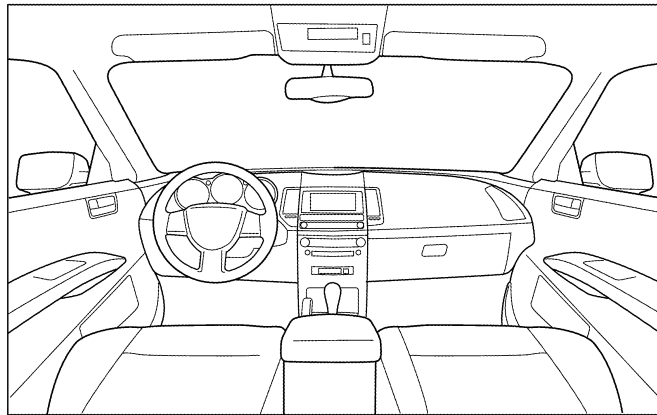

Continue to page 2 of the worksheet and briefly describe the location of the noise or rattle. In addition, please indicate the conditions which are present when the noise occurs.

A  
B  
C  
D  
E  
F  
G  
H  
I  
J  
RF  
L  
M  
N  
O  
P

# SQUEAK AND RATTLE TROUBLE DIAGNOSES

< SYMPTOM DIAGNOSIS >

[WITH SINGLE PANEL SUNROOF]

## SQUEAK & RATTLE DIAGNOSTIC WORKSHEET - page 2

Briefly describe the location where the noise occurs:

---

---

### II. WHEN DOES IT OCCUR? (please check the boxes that apply)

- |   |  |
|---|--|
| <input type="checkbox"/> Anytime                      | <input type="checkbox"/> After sitting out in the rain |
| <input type="checkbox"/> 1st time in the morning      | <input type="checkbox"/> When it is raining or wet     |
| <input type="checkbox"/> Only when it is cold outside | <input type="checkbox"/> Dry or dusty conditions       |
| <input type="checkbox"/> Only when it is hot outside  | <input type="checkbox"/> Other:                        |

### III. WHEN DRIVING:

- Through driveways
- Over rough roads
- Over speed bumps
- Only about \_\_\_\_ mph
- On acceleration
- Coming to a stop
- On turns: left, right or either (circle)
- With passengers or cargo
- Other: \_\_\_\_\_
- After driving \_\_\_\_ miles or \_\_\_\_ minutes

### IV. WHAT TYPE OF NOISE

- Squeak (like tennis shoes on a clean floor)
- Creak (like walking on an old wooden floor)
- Rattle (like shaking a baby rattle)
- Knock (like a knock at the door)
- Tick (like a clock second hand)
- Thump (heavy muffled knock noise)
- Buzz (like a bumble bee)

### TO BE COMPLETED BY DEALERSHIP PERSONNEL

#### Test Drive Notes:

---

---

---

	YES	NO	Initials of person performing
Vehicle test driven with customer	<input type="checkbox"/>	<input type="checkbox"/>	_____
- Noise verified on test drive	<input type="checkbox"/>	<input type="checkbox"/>	_____
- Noise source located and repaired	<input type="checkbox"/>	<input type="checkbox"/>	_____
- Follow up test drive performed to confirm repair	<input type="checkbox"/>	<input type="checkbox"/>	_____

VIN: \_\_\_\_\_ Customer Name \_\_\_\_\_

W.O.# \_\_\_\_\_ Date: \_\_\_\_\_

This form must be attached to Work Order

LAI0071E

# PRECAUTION

## PRECAUTIONS

### Precaution for Supplemental Restraint System (SRS) "AIR BAG" and "SEAT BELT PRE-TENSIONER"

INFOID:000000005461840

The Supplemental Restraint System such as "AIR BAG" and "SEAT BELT PRE-TENSIONER", used along with a front seat belt, helps to reduce the risk or severity of injury to the driver and front passenger for certain types of collision. This system includes seat belt switch inputs and dual stage front air bag modules. The SRS system uses the seat belt switches to determine the front air bag deployment, and may only deploy one front air bag, depending on the severity of a collision and whether the front occupants are belted or unbelted. Information necessary to service the system safely is included in the SR and SB section of this Service Manual.

**WARNING:**

- To avoid rendering the SRS inoperative, which could increase the risk of personal injury or death in the event of a collision which would result in air bag inflation, all maintenance must be performed by an authorized NISSAN/INFINITI dealer.
- Improper maintenance, including incorrect removal and installation of the SRS, can lead to personal injury caused by unintentional activation of the system. For removal of Spiral Cable and Air Bag Module, see the SR section.
- Do not use electrical test equipment on any circuit related to the SRS unless instructed to in this Service Manual. SRS wiring harnesses can be identified by yellow and/or orange harnesses or harness connectors.

### PRECAUTIONS WHEN USING POWER TOOLS (AIR OR ELECTRIC) AND HAMMERS

**WARNING:**

- When working near the Airbag Diagnosis Sensor Unit or other Airbag System sensors with the Ignition ON or engine running, DO NOT use air or electric power tools or strike near the sensor(s) with a hammer. Heavy vibration could activate the sensor(s) and deploy the air bag(s), possibly causing serious injury.
- When using air or electric power tools or hammers, always switch the Ignition OFF, disconnect the battery, and wait at least 3 minutes before performing any service.

### Precautions

INFOID:000000005461841

- After removing and installing any opening/closing parts, make sure to perform all adjustments for proper operation.
- Check the lubrication level, damage, and wear of each part. If necessary, grease or replace it.
- When removing or disassembling any part, be careful not to damage or deform it. Protect parts which may get in the way with cloth.
- When removing parts with a screw driver or other tool, protect parts by wrapping them with vinyl or tape.
- Keep removed parts protected with cloth.
- If a clip is deformed or damaged, replace it.
- If a non-reuseable part is removed, replace it with a new one.
- Tighten bolts and nuts firmly to the specified torque.
- After re-assembly has been completed, make sure each part functions correctly.
- Remove stains in the following manner:

Water-Soluble stains	Oil stains
Dip a cloth in warm water, and squeeze tightly. After wiping the stain, wipe with a soft dry cloth.	Dissolve a synthetic detergent in warm water (density of 2 to 3% or less), dip the cloth, then clean off the stain with the cloth. Next, dip the cloth in fresh water, then squeeze tightly. Clean off detergent completely, then wipe entire area with a soft dry cloth.
Do not use any organic solvent, such as a thinner or benzine to remove stains	

### Precautions Necessary for Steering Wheel Rotation after Battery Disconnect (Early

## PRECAUTIONS

< PRECAUTION >

[WITH SINGLE PANEL SUNROOF]

### Production, With Electronic Steering Column Lock)

INFOID:000000005885938

#### NOTE:

- Before removing and installing any control units, first turn the push-button ignition switch to the LOCK position, then disconnect both battery cables.
- After finishing work, confirm that all control unit connectors are connected properly, then re-connect both battery cables.
- Always use CONSULT-III to perform self-diagnosis as a part of each function inspection after finishing work. If a DTC is detected, perform trouble diagnosis according to self-diagnosis results.

This vehicle is equipped with a push-button ignition switch and a steering lock unit.

If the battery is disconnected or discharged, the steering wheel will lock and cannot be turned.

If turning the steering wheel is required with the battery disconnected or discharged, follow the procedure below before starting the repair operation.

#### OPERATION PROCEDURE

1. Connect both battery cables.

##### NOTE:

Supply power using jumper cables if battery is discharged.

2. Carry the Intelligent Key or insert it to the key slot and turn the push-button ignition switch to ACC position. (At this time, the steering lock will be released.)
3. Disconnect both battery cables. The steering lock will remain released with both battery cables disconnected and the steering wheel can be turned.
4. Perform the necessary repair operation.
5. When the repair work is completed, re-connect both battery cables. With the brake pedal released, turn the push-button ignition switch from ACC position to ON position, then to LOCK position. (The steering wheel will lock when the push-button ignition switch is turned to LOCK position.)
6. Perform self-diagnosis check of all control units using CONSULT-III.

# PREPARATION

< PREPARATION >

[WITH SINGLE PANEL SUNROOF]

## PREPARATION

### PREPARATION

#### Special Service Tools

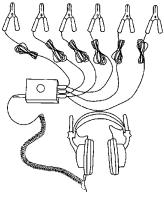
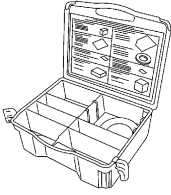

INFOID:000000005461843

The actual shapes of Kent-Moore tools may differ from those of special service tools illustrated here.

Tool number (Kent-Moore No.) Tool name	Description
(J-39570) Chassis ear   SIIA0993E	Locating the noise
(J-43980) NISSAN Squeak and Rattle Kit   SIIA0994E	Repairing the cause of noise

#### Commercial Service Tools

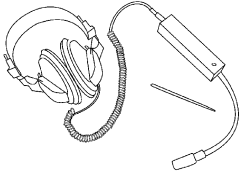
INFOID:000000005461844

Tool name (Kent-Moore No.)	Description
Engine ear (J-39565)   SIIA0995E	Locating the noise
Power tools   PIIB1407E	Loosening bolts, nuts and screws

# SUNROOF UNIT ASSEMBLY

< ON-VEHICLE REPAIR >

[WITH SINGLE PANEL SUNROOF]

## ON-VEHICLE REPAIR

### SUNROOF UNIT ASSEMBLY

#### Inspection

INFOID:000000005461845

#### WIND DEFLECTOR

1. Open glass lid assembly fully.
2. Visually check for proper installation, damaged/deteriorated components, or foreign objects within mechanism. Correct as required for smooth operation.
3. Check for grease at the wind deflector arm (1) and pivot areas. If necessary, apply a sufficient amount of grease for non-binding operation.

↔:Vehicle front

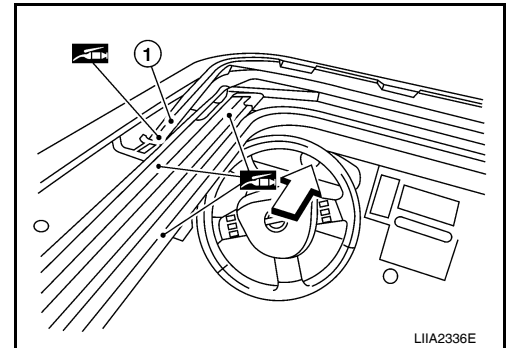

4. Check that the wind deflector (1) moves freely within the sunroof unit assembly while manually pressing down and releasing. If a malfunction is detected, remove the sunroof unit assembly and visually inspect. If damage is found, replace either wind deflector (1) or sunroof unit assembly as required.

↔:Vehicle front

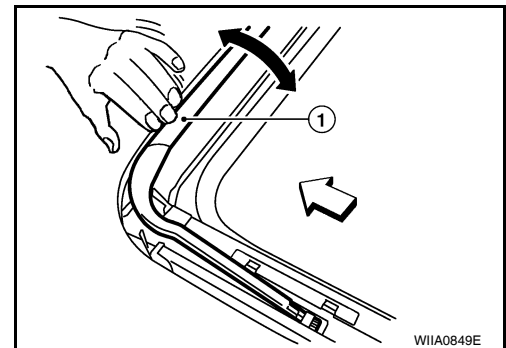

#### LINK AND WIRE ASSEMBLY

##### NOTE:

Before replacing a suspect part, make sure it is the source of noise being experienced.

1. Check link to determine if coating film has peeled off excessively enough that substrate is visible. Check also to determine if link is the source of noise. Replace as necessary.
2. Visually check to determine if a sufficient amount of grease has been applied to wire or rail groove. If not, add grease as required.
3. Check wire for any damage or deterioration. If any damage is found, replace sunroof unit assembly.

#### WEATHERSTRIP

1. Visually check weatherstrip for damage, deterioration, or deformation.
  - Open glass lid assembly partially to inspect front edge of weatherstrip.
  - Tilt up glass lid assembly fully to inspect sides and rear edge of weatherstrip.If any area of the weatherstrip is found to be damaged, replace the glass lid assembly. Refer to [RF-84, "Removal and Installation"](#).
2. Check for leakage around glass lid assembly.
  - Close glass lid assembly.
  - Pour water around surface to determine area of concern.
    - For gaps or misalignment, adjust glass lid assembly to specifications. Refer to ADJUSTMENT in this section.
    - For damaged sealing surfaces, either replace glass lid assembly [RF-84, "Removal and Installation"](#), or repair the panel.

#### DRAIN HOSES



# SUNROOF UNIT ASSEMBLY

< ON-VEHICLE REPAIR >

[WITH SINGLE PANEL SUNROOF]

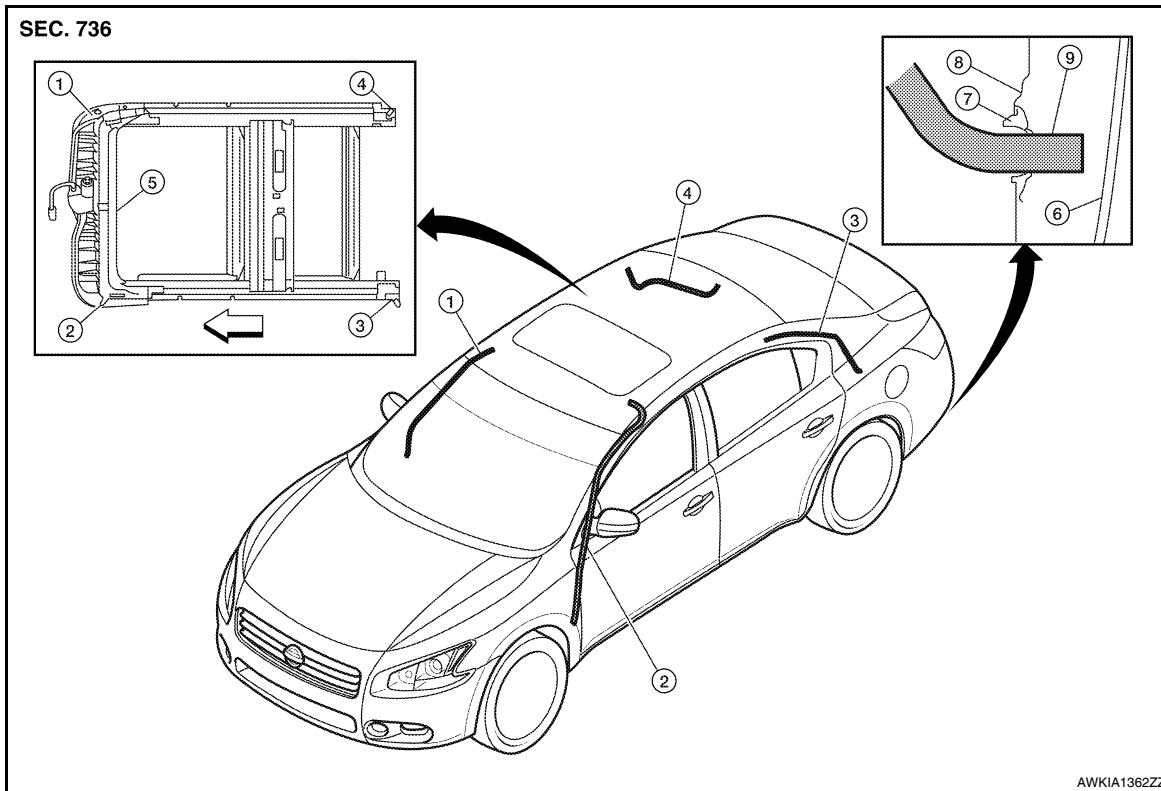

- |                        |                          |                       |
|------------------------|--------------------------|-----------------------|
| 1. Drain hose front RH | 2. Drain hose front LH   | 3. Drain hose rear LH |
| 4. Drain hose rear RH  | 5. Sunroof unit assembly | 6. Fascia             |
| 7. Seal                | 8. Fender                | 9. Drain hose         |
- ← Vehicle front

1. Remove the headlining. Refer to [INT-32. "Removal and Installation"](#).
2. Visually check drain hoses for:
  - Proper connection at sunroof unit assembly drain hose connector(s).
  - Damage, pinch, cracks, deterioration.
  - Proper fastening and routing on body panels.
3. Pour water through drain hoses to determine watertight performance.  
If damaged or leaking portions in any drain hose is found, replace entire drain hose as necessary.

## ADJUSTMENT

### CAUTION:

- Always work with a helper.
- Handle glass lid assembly with care to prevent damage.

### NOTE:

- For easier and more accurate installation, always mark each point before removal.
- After any adjustment, check sunroof operation and glass lid assembly alignment.

# SUNROOF UNIT ASSEMBLY

< ON-VEHICLE REPAIR >

[WITH SINGLE PANEL SUNROOF]

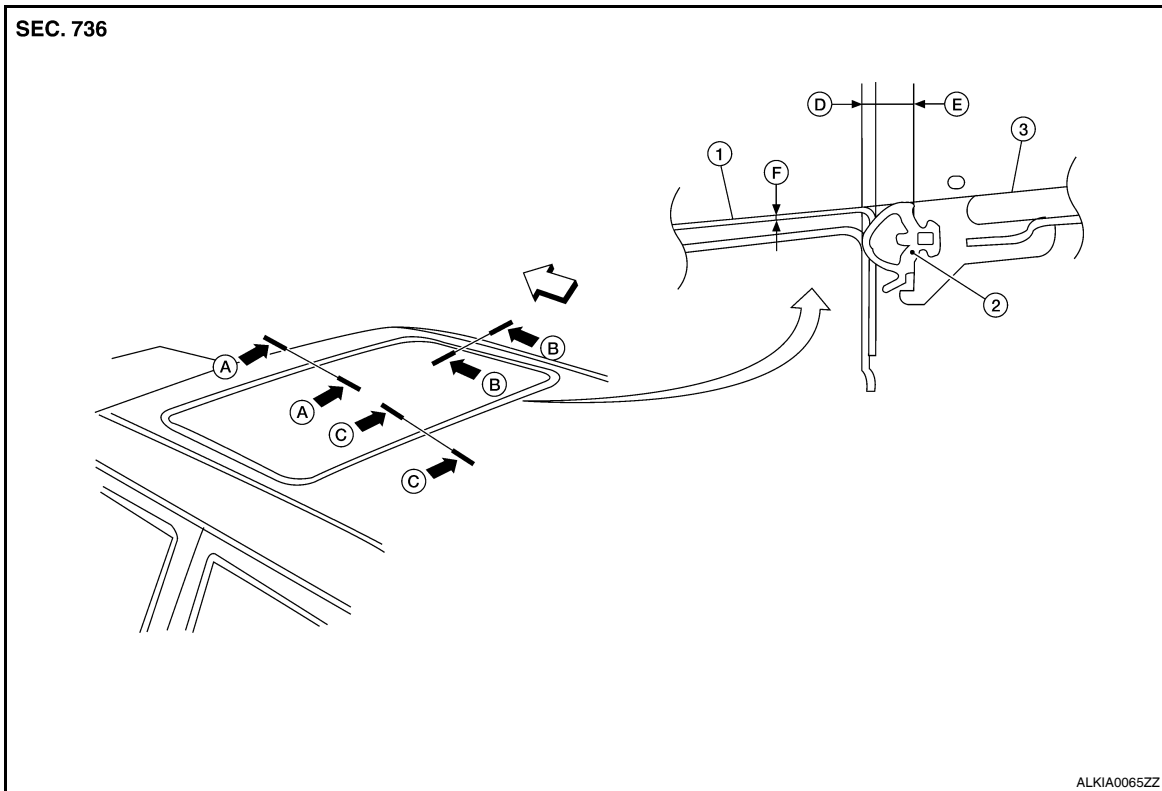

- |                                   |                                 |  |
|-----------------------------------|---------------------------------|--|
| 1. Roof                           | 2. Weatherstrip                 | 3. Glass lid assembly                                      |
| A. Front edge specifications      | B. Side edge specifications     | C. Rear edge specifications                                |
| D. Weatherstrip overlap tolerance | E. Weatherstrip width dimension | F. Surface flushness tolerance (Glass lid below roof line) |

↶ Vehicle front

Unit: mm (in)

	A-A	B-B	C-C
D.	1.4 ± 0.45 (0.06 ± 0.02)	1.4 ± 0.45 (0.06 ± 0.02)	1.4 ± 0.45 (0.06 ± 0.02)
E.	5.8 ± (0.23)	5.8 ± (0.23)	5.8 ± (0.23)
F.	-0.8 ± 1.5 (-0.03 ± 0.06)	-0.8 ± 1.5 (-0.03 ± 0.06)	-0.8 ± 1.5 (-0.03 ± 0.06)

## Gap adjustment (A-A, C-C)

- Open sunshade assembly (1).  
↶ Vehicle front
- Tilt glass lid assembly up, then release side trim cover (2) and set aside.
- Loosen glass lid assembly bolts (A) (2 each on left and right sides), then tilt glass lid assembly down.
- Manually adjust glass lid assembly from outside of vehicle so gaps A-A and C-C are within specifications.

### NOTE:

Temporarily snug glass lid assembly bolts to prevent movement between each adjustment.

- Tilt glass lid assembly up and down several times using sunroof switch to check that it operates smoothly.
- Tilt glass lid assembly up and tighten bolts to specification.

### NOTE:

First tighten left front bolt, then right rear bolt on glass lid assembly to prevent uneven torque while tightening remaining bolts.

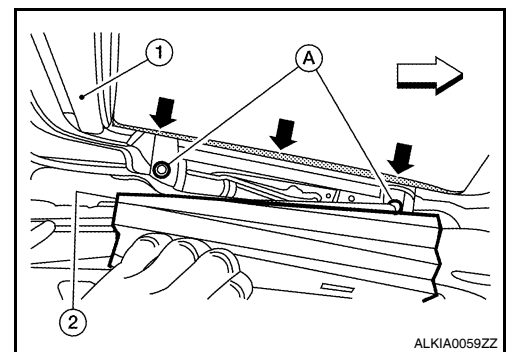

ALKIA0059ZZ

# SUNROOF UNIT ASSEMBLY

< ON-VEHICLE REPAIR >

[WITH SINGLE PANEL SUNROOF]

7. Attach side trim cover, then tilt glass lid assembly down.

## Gap Adjustment (B-B)

1. Remove headlining. Refer to [INT-32, "Removal and Installation"](#).
2. Loosen sunroof unit assembly and sunroof side bracket bolts.
3. Carefully slide sunroof unit assembly side to side or add shims until gap is within specifications.  
**NOTE:**  
Temporarily snug sunroof unit assembly bolts to prevent movement between each adjustment.
4. Tilt glass lid assembly up and down several times using sunroof switch to check that it operates smoothly.
5. Tighten sunroof unit assembly and sunroof side bracket bolts.  
**NOTE:**  
First tighten left front sunroof unit assembly bolt, then right rear to prevent uneven torque while tightening remaining bolts.
6. Install headlining. Refer to [INT-32, "Removal and Installation"](#).

## Height Adjustment

1. Tilt glass lid assembly up and down several times using sunroof switch to check that it operates smoothly.
2. Check height difference between roof surface and glass lid assembly surface, then compare to specifications.
3. If necessary, adjust height difference by using the following procedure.
  - Loosen glass lid assembly bolts.
  - Manually raise/lower glass lid assembly until height difference is within specification.  
**NOTE:**  
If necessary, shims may be added between sunroof unit assembly and roof to increase adjustment range. Refer to [RF-80, "Inspection"](#).  
Temporarily snug sunroof unit assembly bolts to prevent movement between each adjustment.
  - Tilt glass lid assembly up and down several times using sunroof switch to check that it operates smoothly.
  - Tighten glass lid assembly and sunroof side bracket bolts.  
**NOTE:**  
First tighten left front bolt, then right rear bolt on glass lid assembly to prevent uneven torque while tightening remaining bolts.
  - After any adjustment, check sunroof operation and glass lid assembly alignment.

A  
B  
C  
D  
E  
F  
G  
H  
I  
J  
L  
M  
N  
O  
P

RF

# SUNROOF UNIT ASSEMBLY

< ON-VEHICLE REPAIR >

[WITH SINGLE PANEL SUNROOF]

Exploded View

INFOID:000000005461846

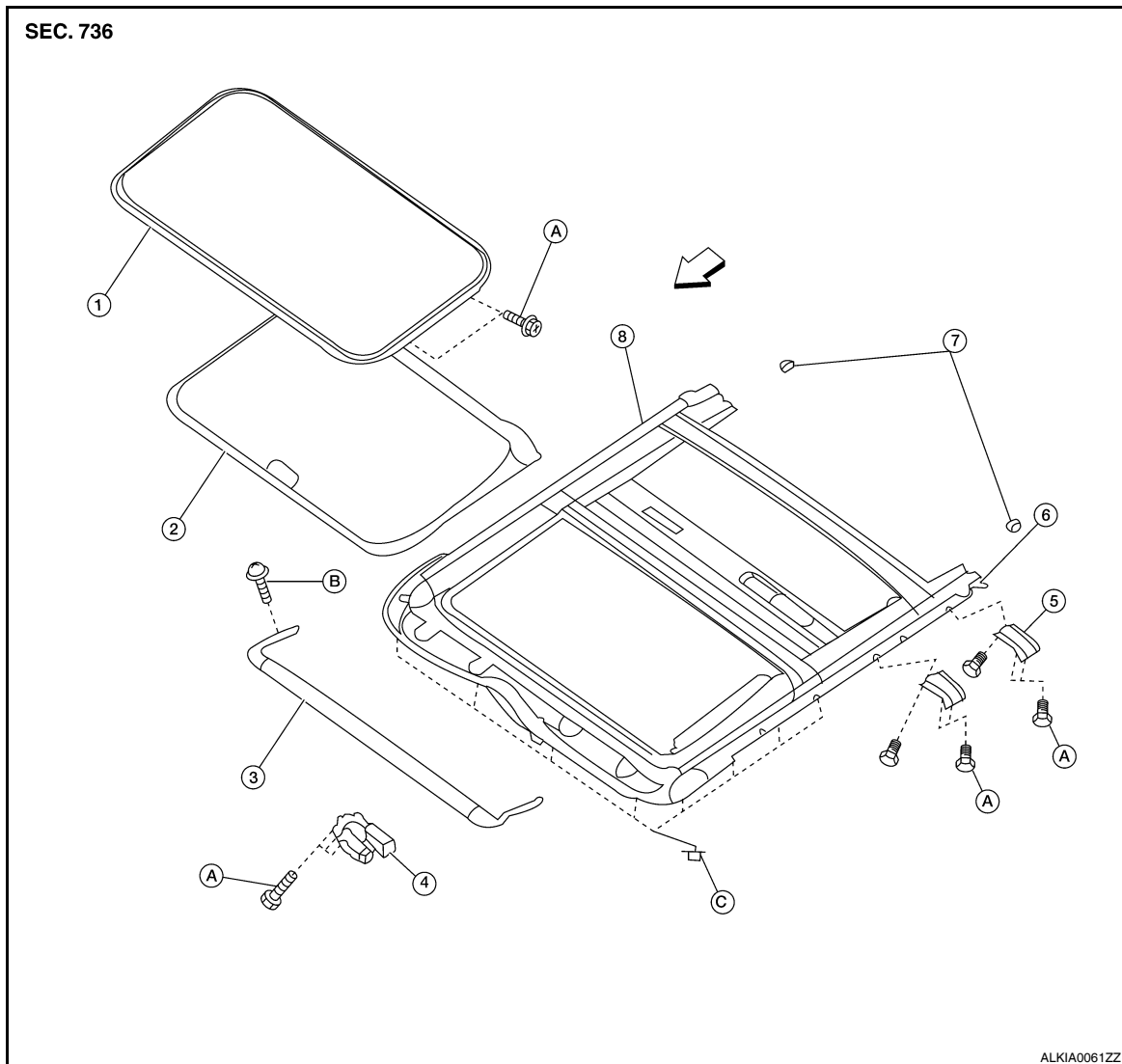

- |                           |                          |                         |
|---------------------------|--------------------------|-------------------------|
| 1. Glass lid assembly     | 2. Sunshade              | 3. Wind deflector       |
| 4. Sunroof motor assembly | 5. Sunroof side bracket  | 6. Drain hose connector |
| 7. Sunshade stopper       | 8. Sunroof unit assembly | A. Bolt                 |
| B. Screw                  | C. Nut                   | ← Vehicle front         |

## Removal and Installation

INFOID:000000005461847

### CAUTION:

- After installing either sunroof unit assembly or glass lid assembly, check gap/height adjustments and operation to make sure there is no malfunction.
- Always work with a helper.
- Handle glass lid assembly with care to prevent damage.
- When taking sunroof unit out, use shop cloths to protect the seats and trim from damage.

### SUNROOF UNIT ASSEMBLY

#### Removal

1. Close glass lid assembly.
2. Remove headlining. Refer to [INT-32, "Removal and Installation"](#).
3. Disconnect drain hoses.

# SUNROOF UNIT ASSEMBLY

[WITH SINGLE PANEL SUNROOF]

## < ON-VEHICLE REPAIR >

- Remove screws (A), then pull sunroof switch bracket (1) away from sunroof unit assembly (2).  
↳ Vehicle front
- Disconnect sunroof motor harness connector.

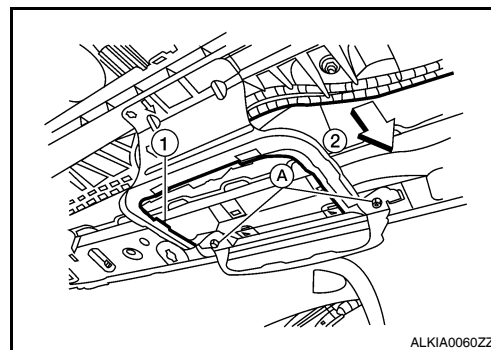

- Remove bolts on the front end and side rails of the sunroof unit assembly.
- Remove front sunroof side bracket bolts.
- Remove rear sunroof side bracket bolts and remove sunroof unit assembly from roof panel.
- Remove sunroof unit assembly through the passenger compartment while being careful not to damage the seats and trim.

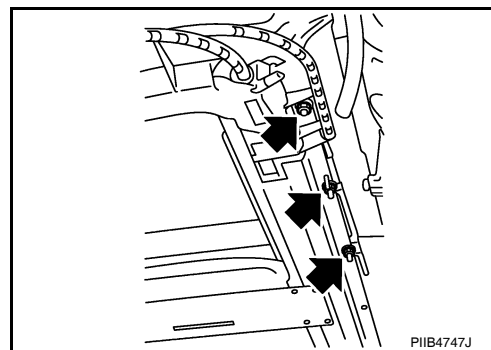

## Installation

- Loosely tighten the rear sunroof side bracket bolts to the sunroof unit assembly side rails.
- Bring sunroof unit into passenger compartment and loosely tighten rear sunroof side bracket bolts to roof panel while supporting front.
- Align the sunroof unit assembly front end rail and side rails with the locator pins, then loosely tighten the bolts.
- Install remaining sunroof side brackets and loosely tighten bolts.
- Tighten the sunroof unit assembly front end and side rail bolts diagonally to the specified torque.
- Tighten the front sunroof side bracket bolts at the vehicle side first, then at the side rail end.
- Tighten the rear sunroof side bracket bolts at the vehicle side first, then at the side rail end.
- Connect sunroof motor harness connector.
- Install sunroof switch bracket.
- Connect drain hoses.
- Install headlining. Refer to [INT-32. "Removal and Installation"](#).

## GLASS LID ASSEMBLY

### Removal

- Open sunshade (1), then close glass lid assembly.  
↳ Vehicle front
- Slide the side trim covers (2) RH/LH inward, then release them from the glass lid assembly inside edge and set aside.
- Remove the bolts (A) and glass lid assembly from sunroof unit assembly.

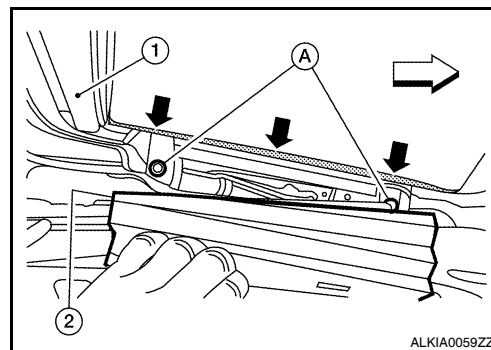

### Installation

- Position glass lid assembly to sunroof unit assembly.
- Tighten glass lid assembly bolts to specification.

**NOTE:**

# SUNROOF UNIT ASSEMBLY

[WITH SINGLE PANEL SUNROOF]

< ON-VEHICLE REPAIR >

First tighten left front bolt, then right rear bolt on glass lid assembly to prevent uneven torque while tightening remaining bolts.

3. Slide side trim covers onto inside edge of glass lid assembly.
4. After installation, check sunroof operation and glass lid assembly alignment. Refer to [RF-80. "Inspection"](#).

## SUNSHADE

### Removal

1. Remove sunroof unit assembly. Refer to [RF-84. "Exploded View"](#).
2. Remove glass lid assembly. Refer to [RF-84. "Removal and Installation"](#).
3. Remove the sunshade stoppers (1) RH/LH from the sunroof unit assembly side rails (2).  
↳ Vehicle front
4. Slide sunshade rearward past sunroof unit assembly side rail ends to remove.

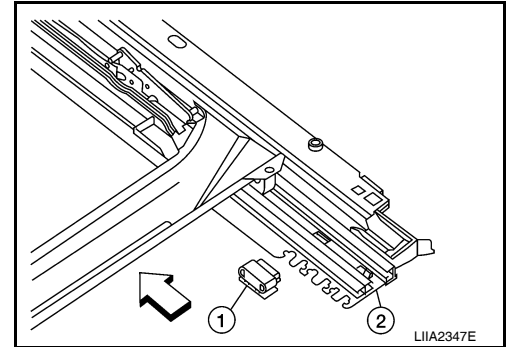

### Installation

Installation is in the reverse order of removal.

## SUNROOF MOTOR

### Removal

1. Close glass lid assembly.
2. Disconnect the negative and positive battery cables.
3. Remove front room/map lamp assembly from headliner (4). Refer to [INL-97. "Removal and Installation"](#).  
↳ Vehicle front
4. Remove sunroof motor screws (A).
5. Disconnect harness connector (2) and remove sunroof motor (1) from sunroof unit assembly front end rail.

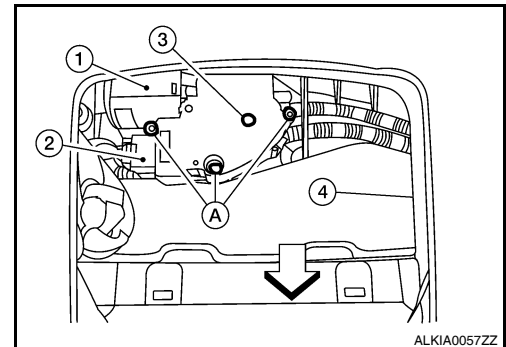

### CAUTION:

**Never run the removed sunroof motor as a single unit.**

### Installation

1. Move sunroof motor laterally little by little so that the gear is completely engaged into the wire on the sunroof unit assembly, and the mounting surfaces become parallel. Install the sunroof motor screws, and tighten to the specified torque.

### CAUTION:

**Before installing the motor, be sure to place the link and wire assembly in the symmetrical and fully closed position.**

### NOTE:

If necessary, insert a suitable tool into the drive key (3) and rotate right or left slightly to assist in complete sunroof motor gear alignment.

Remainder of installation is in the reverse order of removal.

2. Connect battery positive and negative terminals.
3. Synchronize sunroof motor with sunroof unit assembly. Refer to [RF-7. "ADDITIONAL SERVICE WHEN REPLACING CONTROL UNIT : Special Repair Requirement"](#).

# DIAGNOSIS AND REPAIR WORKFLOW

< BASIC INSPECTION >

[WITH DUAL PANEL SUNROOF]

## BASIC INSPECTION

### DIAGNOSIS AND REPAIR WORKFLOW

#### WorkFlow

INFOID:000000005461848

#### DETAILED FLOW

#### 1.OBTAIN INFORMATION ABOUT SYMPTOM

Interview the customer to obtain the malfunction information (conditions and environment when the malfunction occurred) as much as possible when the customer brings the vehicle in.

>> GO TO 2.

#### 2.REPRODUCE THE MALFUNCTION INFORMATION

Check the malfunction on the vehicle that the customer describes.  
Inspect the relation of the symptoms and the condition when the symptoms occur.

>> GO TO 3.

#### 3.IDENTIFY THE MALFUNCTIONING SYSTEM WITH "SYMPTOM DIAGNOSIS"

Use "Symptom diagnosis" from the symptom inspection result in step 2 and then identify where to start performing the diagnosis based on possible causes and symptoms.

>> GO TO 4.

#### 4.IDENTIFY THE MALFUNCTIONING PARTS WITH "COMPONENT DIAGNOSIS"

Perform the diagnosis with "Component diagnosis" of the applicable system.

>> GO TO 5.

#### 5.REPAIR OR REPLACE THE MALFUNCTIONING PARTS

Repair or replace the specified malfunctioning parts.

>> GO TO 6.

#### 6.FINAL CHECK

Check that malfunctions are not reproduced when obtaining the malfunction information from the customer, referring to the symptom inspection result in step 2.

Are the malfunctions corrected?

YES >> Inspection End.

NO >> GO TO 3.

A  
B  
C  
D  
E  
F  
G  
H  
I  
J  
RF  
L  
M  
N  
O  
P

# INSPECTION AND ADJUSTMENT

< BASIC INSPECTION >

[WITH DUAL PANEL SUNROOF]

## INSPECTION AND ADJUSTMENT

### ADDITIONAL SERVICE WHEN REPLACING CONTROL UNIT

#### ADDITIONAL SERVICE WHEN REPLACING CONTROL UNIT : Description

INFOID:000000005461849

Initialization of system should be conducted after the following conditions.

- When the sunroof motor or sunshade motor is changed.
- When the sunroof or sunshade does not operate normally (incomplete initialization conditions).

#### ADDITIONAL SERVICE WHEN REPLACING CONTROL UNIT : Special Repair Requirement

INFOID:000000005461850

#### INITIALIZATION PROCEDURE

If the sunroof or sunshade does not close or open automatically, use the following procedure to return sunroof or sunshade operation to normal.

1. Close the sunroof and sunshade, then release the sunroof switch once.
2. Press and hold the sunroof switch CLOSE (1st or 2nd) again (for approx. 10 seconds), then sunroof will move to forward and it will be stopped mechanically.
3. Release the sunroof switch, and press and hold the sunroof switch CLOSE (1st or 2nd) again, then sunroof and sunshade will automatically move to fully closed⇒fully open⇒fully closed.
4. Release sunroof switch, after the sunroof is fully closed.
5. Check sunroof and sunshade operation.

#### CHECK ANTI-PINCH FUNCTION

1. Full open the sunroof.
2. Place a piece of wood near fully closed position.
3. Close the sunroof completely with auto-slide close.
4. Check that sunroof lowers for approximately 150 mm (5.91 in) or 2 seconds without pinching a piece of wood and stop.
5. Full open the sunshade.
6. Place a piece of wood near fully closed position.
7. Close the sunroof completely with auto-slide close.
8. Check that sunroof lowers for approximately 150 mm (5.91 in) or 2 seconds without pinching a piece of wood and stop.

#### **CAUTION:**

- **Do not check with hands and other part of body because they may be pinched. Do not get pinched.**
- **Depending on environment and driving conditions, if a similar impact or load is applied to the sunroof it may lower.**
- **Check that auto-slide operates before inspection when system initialization is performed.**
- **Perform initial setting when auto-slide operation or anti-pinch function does not operate normally.**



# SUNROOF SYSTEM

< FUNCTION DIAGNOSIS >

[WITH DUAL PANEL SUNROOF]

## FUNCTION DIAGNOSIS

### SUNROOF SYSTEM

#### System Diagram

INFOID:000000005461851

#### SUNROOF

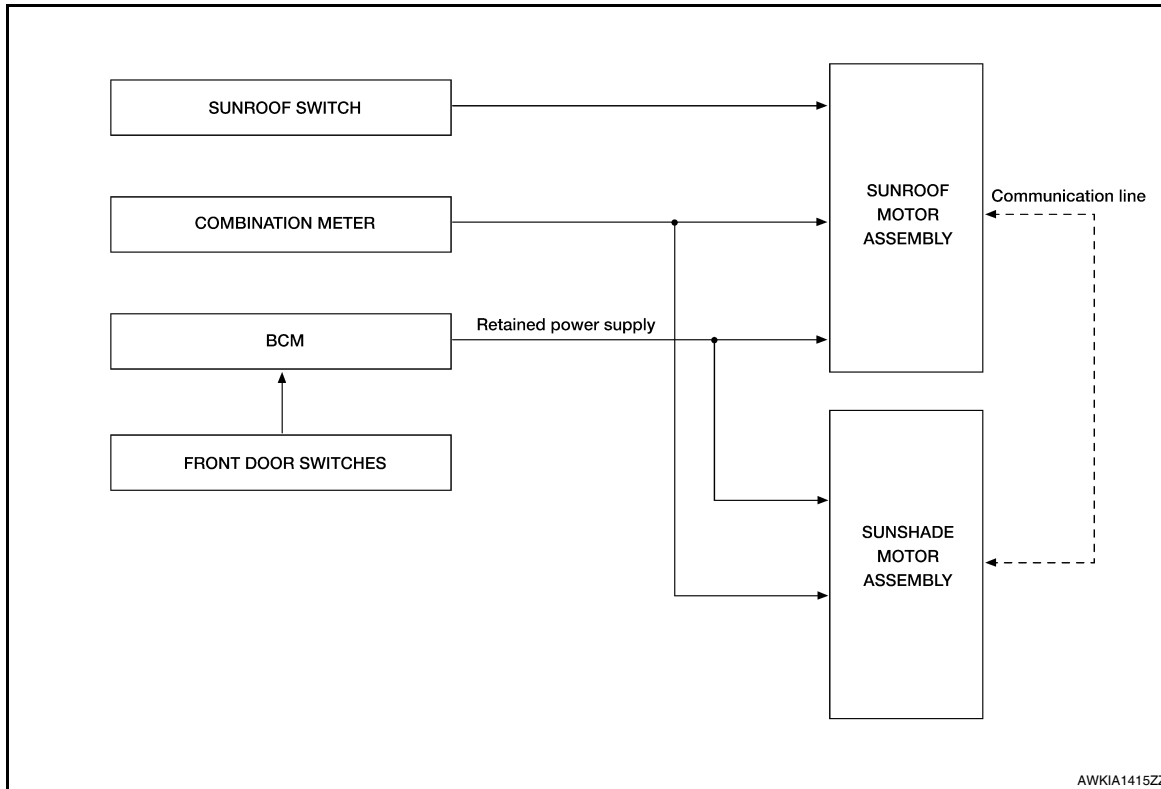

#### System Description

INFOID:000000005461852

#### DESCRIPTION

- Sunroof motor assembly and sunshade motor assembly operate with the power supplied from BCM while ignition switch is ON or retained power is operating.
- Sunroof motor assembly receives an operation signal from sunroof switch, and sends the signal to sunshade motor by communication line.
- Sunroof motor assembly and sunshade motor assembly receive a vehicle speed signal from combination meter and controls the sunroof motor and sunshade motor torque at the time of high speed operation.
- The sunroof switch can be operated in the directions of push/tilt, open (1st, 2nd) and close (1st, 2nd). It can operate the sunroof and sunshade by one switch.

- (1) OPEN
- (2) CLOSE
- (3) PUSH/TILT

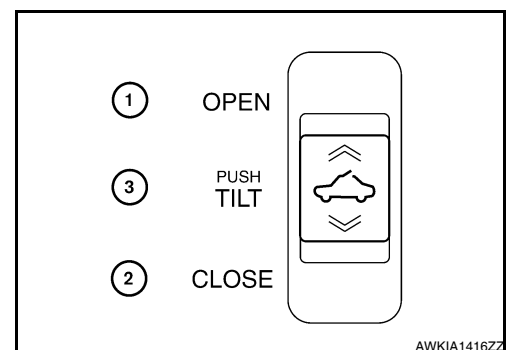







#### OPERATION DESCRIPTION

The sunroof and sunshade operate to the following condition by the sunroof switch operation.

# SUNROOF SYSTEM

< FUNCTION DIAGNOSIS >





[WITH DUAL PANEL SUNROOF]

Before Operation	Switch condition	Roof and sunshade operation	After Operation
 <p>JMKIA1885ZZ</p>	<p>OPEN: 1st</p>	<p>Open the shade</p>	 <p>JMKIA1884ZZ</p>
	<p>OPEN: 2nd</p>	<p>Open the glass and shade (AUTO)</p>	 <p>JMKIA1887ZZ</p>
	<p>PUSH</p>	<p>Tilt up and open the shade at the same time</p>	 <p>JMKIA1886ZZ</p>
 <p>JMKIA1886ZZ</p>	<p>PUSH</p>	<p>Tilt down</p>	 <p>JMKIA1884ZZ</p>
	<p>CLOSE: 1st</p>		
	<p>CLOSE: 2nd</p>	<p>Tilt down and close the shade at the same time (AUTO)</p>	 <p>JMKIA1885ZZ</p>

# SUNROOF SYSTEM

< FUNCTION DIAGNOSIS >

[WITH DUAL PANEL SUNROOF]

Before Operation	Switch condition	Roof and sunshade operation	After Operation
  JMKIA1887ZZ	PUSH	Tilt up	 JMKIA1886ZZ
	CLOSE: 1st	Close the glass	 JMKIA1884ZZ
	CLOSE: 2nd	Close the glass and shade at the same time (AUTO)	 JMKIA1885ZZ

## AUTO OPERATION

The sunroof or sunshade operate automatically to the fully-open or fully-close position by operating the sunroof switch to the OPEN (2nd) or CLOSE (2nd) position.

## RETAINED POWER OPERATION

Retained power operation is an additional power supply function that enables the sunroof system to operate for 45 seconds after ignition switch is turned OFF.

### Retained power function cancel conditions

- Front door CLOSE (door switch OFF)→OPEN (door switch ON)
- Ignition switch is ON again.
- Timer passed (45 seconds)

## ANTI-PINCH FUNCTION

### CAUTION:

**There are some small distances immediately before the closed position which cannot be detected.**

- The CPU of sunroof motor assembly monitors the sunroof condition by the signals from sunroof motor. When sunroof motor assembly detects an interruption during auto operation (close or tilt down operation), sunroof motor will tilt up or open [150 mm (5.91 in) or more] sunroof.
- The CPU of sunshade motor assembly monitors the sunshade condition by the signals from sunshade motor. When sunshade motor assembly detects an interruption during auto close operation, sunroof motor will open [150 mm (5.91 in) or more] sunshade.

## Component Parts Location

INFOID:000000005461853

# SUNROOF SYSTEM

< FUNCTION DIAGNOSIS >

[WITH DUAL PANEL SUNROOF]

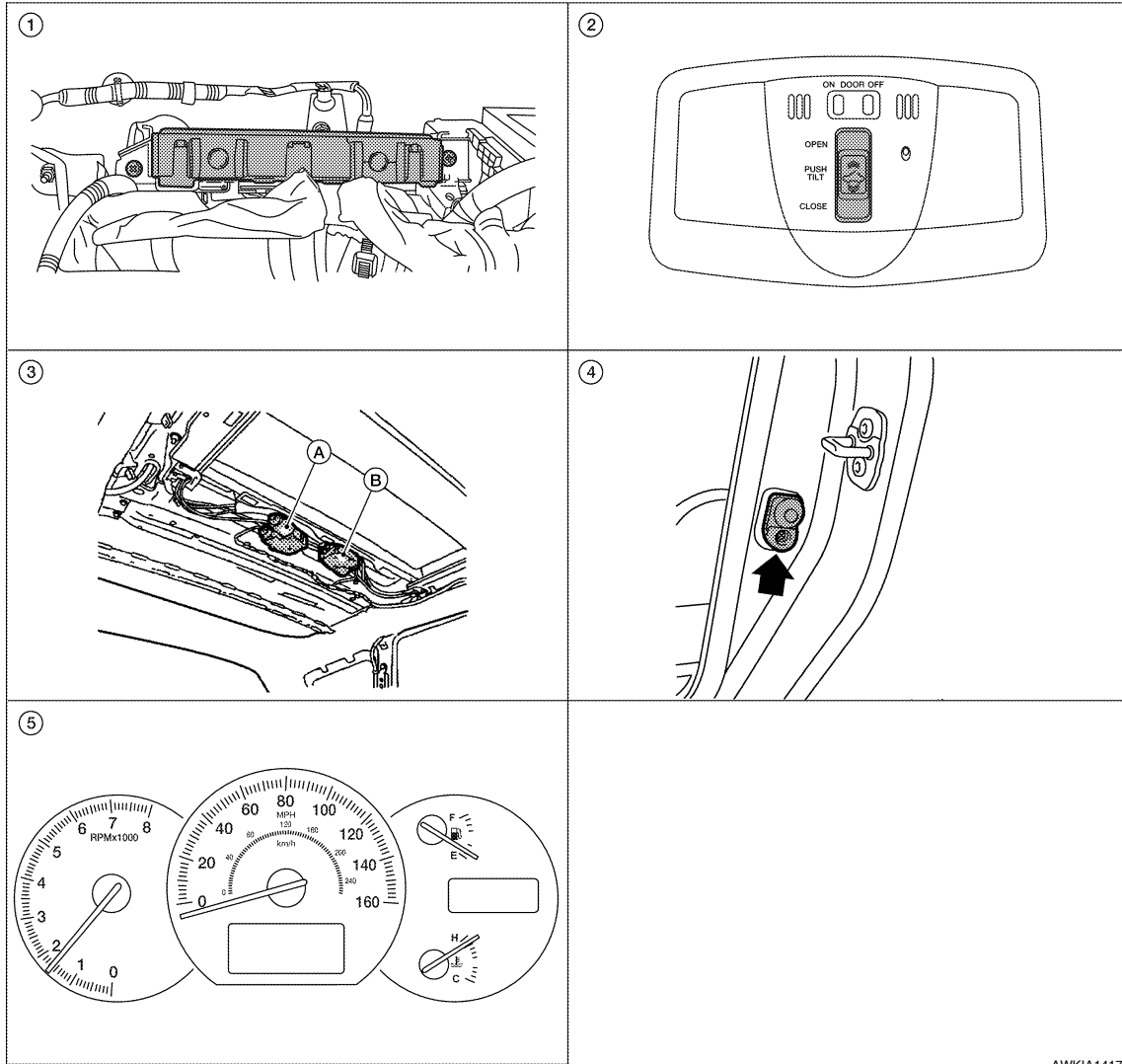

AWKIA1417ZZ

1. BCM M16, M17, M18 (view with instrument panel removed)
2. Sunroof switch R14
3. A: Sunroof motor assembly R101  
B: Sunshade motor assembly R102 (view with headlining removed)
4. Front door switch LH B8, RH B108
5. Combination meter M24

## Component Description

INFOID:000000005461854

Component	Function
BCM	Supplies power to sunroof motor assembly and sunshade motor assembly.
Combination meter	Transmits vehicle speed signal to sunroof motor assembly and sunshade motor assembly.
Sunroof motor assembly	It is sunroof motor and CPU integrated type that enables tilt up/down & slide open/close sunroof by sunroof switch operation. And sends sunroof switch operation signal to sunshade motor assembly via communication line.
Sunshade motor assembly	It is sunshade motor and CPU integrated type that enables open/close sunshade by sunroof switch operation.
Sunroof switch	Transmits switch operation signal to sunroof motor assembly.
Front door switches	Detects door open/close condition and transmits to BCM.

# DIAGNOSIS SYSTEM (BCM)

< FUNCTION DIAGNOSIS >

[WITH DUAL PANEL SUNROOF]

## DIAGNOSIS SYSTEM (BCM)

### COMMON ITEM

#### COMMON ITEM : Diagnosis Description

INFOID:000000005511866

#### BCM CONSULT-III FUNCTION

CONSULT-III performs the following functions via CAN communication with BCM.

Diagnosis mode	Function Description
WORK SUPPORT	Changes the setting for each system function.
SELF DIAGNOSTIC RESULT	Displays the diagnosis results judged by BCM.
CAN DIAG SUPPORT MNTR	Monitors the reception status of CAN communication viewed from BCM.
DATA MONITOR	The BCM input/output signals are displayed.
ACTIVE TEST	The signals used to activate each device are forcibly supplied from BCM.
ECU IDENTIFICATION	The BCM part number is displayed.
CONFIGURATION	<ul style="list-style-type: none"> <li>Enables to read and save the vehicle specification.</li> <li>Enables to write the vehicle specification when replacing BCM.</li> </ul>

#### SYSTEM APPLICATION

BCM can perform the following functions for each system.

#### NOTE:

It can perform the diagnosis modes except the following for all sub system selection items.

System	Sub system selection item	Diagnosis mode		
		WORK SUPPORT	DATA MONITOR	ACTIVE TEST
Door lock	DOOR LOCK	×	×	×
Rear window defogger	REAR DEFOGGER		×	×
Warning chime	BUZZER		×	×
Interior room lamp timer	INT LAMP	×	×	×
Exterior lamp	HEADLAMP	×	×	×
Wiper and washer	WIPER	×	×	×
Turn signal and hazard warning lamps	FLASHER	×	×	×
Intelligent Key system	INTELLIGENT KEY	×	×	×
Combination switch	COMB SW		×	
BCM	BCM	×		
Immobilizer	IMMU		×	×
Interior room lamp battery saver	BATTERY SAVER	×	×	×
Trunk open	TRUNK		×	×
Vehicle security system	THEFT ALM	×	×	×
RAP system	RETAINED PWR		×	
Signal buffer system	SIGNAL BUFFER		×	×
TPMS	AIR PRESSURE MONITOR	×	×	×

#### COMMON ITEM : CONSULT-III Function

INFOID:000000005511867

#### ECU IDENTIFICATION

Displays the BCM part No.

#### SELF-DIAG RESULT

Refer to [RF-141, "DTC Index"](#).

#### RETAINED PWR

# DIAGNOSIS SYSTEM (BCM)

< FUNCTION DIAGNOSIS >

[WITH DUAL PANEL SUNROOF]

RETAINED PWR : CONSULT-III Function (BCM - RETAINED PWR)

INFOID:000000005511868

Data monitor

Monitor Item [Unit]	Description
DOOR SW-DR [ON/OFF]	Indicates condition of front door switch LH.
DOOR SW-AS [ON/OFF]	Indicates condition of front door switch RH.

# POWER SUPPLY AND GROUND CIRCUIT

< COMPONENT DIAGNOSIS >

[WITH DUAL PANEL SUNROOF]

## COMPONENT DIAGNOSIS

### POWER SUPPLY AND GROUND CIRCUIT

#### BCM

#### BCM : Diagnosis Procedure

INFOID:000000005530304

Regarding Wiring Diagram information, refer to [BCS-69, "Wiring Diagram"](#).

### 1. CHECK FUSE AND FUSIBLE LINK

Check if the following BCM fuses or fusible link are blown.

Terminal No.	Signal name	Fuse and fusible link No.
1	Battery power supply	H
11		10
24		7

Is the fuse or fusible link blown?

- YES >> Replace the blown fuse or fusible link after repairing the affected circuit.
- NO >> GO TO 2

### 2. CHECK POWER SUPPLY CIRCUIT

1. Turn ignition switch OFF.
2. Disconnect BCM.
3. Check voltage between BCM harness connector and ground.

Terminals		Voltage (Approx.)
(+)	(-)	
BCM		Ground Battery voltage
Connector	Terminal	
M16 (A)	1	
M17 (B)	11	
M18 (C)	24	

Is the measurement normal?

- YES >> GO TO 3
- NO >> Repair or replace harness.

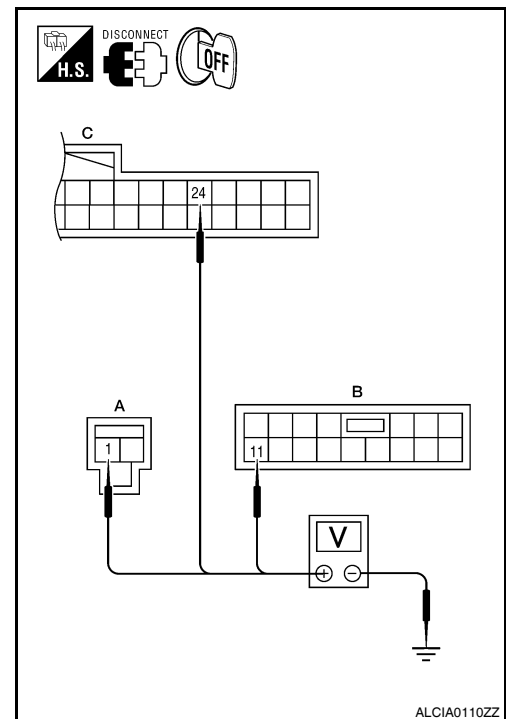

### 3. CHECK GROUND CIRCUIT

# POWER SUPPLY AND GROUND CIRCUIT

[WITH DUAL PANEL SUNROOF]

## < COMPONENT DIAGNOSIS >

Check continuity between BCM harness connector and ground.

BCM		Ground	Continuity
Connector	Terminal		
M17	13		Yes

Does continuity exist?

- YES >> Inspection End.
- NO >> Repair or replace harness.

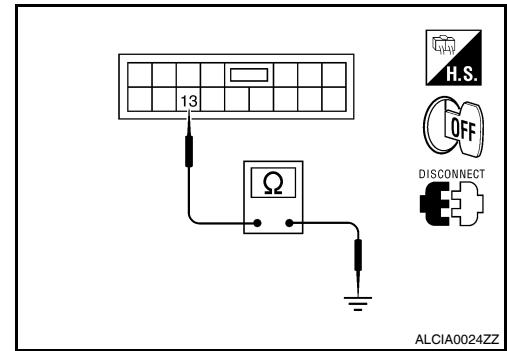

## SUNROOF MOTOR ASSEMBLY

### SUNROOF MOTOR ASSEMBLY : Diagnosis Procedure

INFOID:000000005461860

Regarding Wiring Diagram information, refer to [RF-145, "Wiring Diagram"](#).

### 1. CHECK POWER SUPPLY

1. Turn ignition switch OFF.
2. Disconnect sunroof motor assembly connector.
3. Turn ignition switch ON.
4. Check voltage between sunroof motor assembly harness connector and ground.

(+)		(-)	Voltage (V) (Approx.)
Connector	Terminal		
R101	3	Ground	Battery voltage
	6		

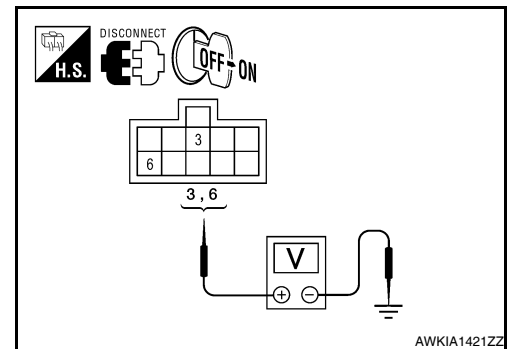

Is the inspection result normal?

- YES >> GO TO 2.
- NO >> GO TO 3.

### 2. CHECK GROUND CIRCUIT

1. Turn ignition switch OFF.
2. Check continuity between sunroof motor assembly harness connector and ground.

Sunroof motor assembly		Ground	Continuity
Connector	Terminal		
R101	1		Yes
	2		

Is the inspection result normal?

- YES >> GO TO 4.
- NO >> Repair or replace the harness.

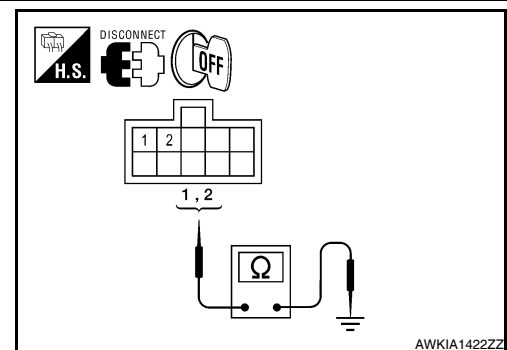

### 3. CHECK SUNROOF MOTOR CIRCUIT



# POWER SUPPLY AND GROUND CIRCUIT

[WITH DUAL PANEL SUNROOF]

## < COMPONENT DIAGNOSIS >

1. Turn ignition switch OFF.
2. Disconnect BCM connector.
3. Check continuity between BCM harness connector (A) and sunroof motor assembly harness connector (B).

BCM (A)		Sunroof motor assembly (B)		Continuity
Connector	Terminal	Connector	Terminal	
M118	2	R101	6	Yes
	3		3	

4. Check continuity between BCM harness connector and ground.

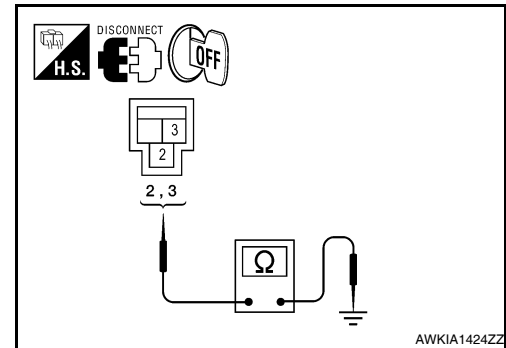
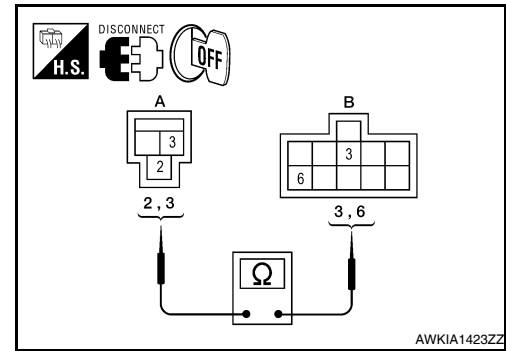

BCM		Ground	Continuity
Connector	Terminal		
M118	2		No
	3		

Is the inspection result normal?

YES >> Replace the BCM. Refer to [BCS-87. "Removal and Installation"](#).

NO >> Repair or replace the harness.

## 4. CHECK INTERMITTENT INCIDENT

Refer to [GI-39. "Intermittent Incident"](#).

>> Inspection End.

## SUNSHADE MOTOR ASSEMBLY

### SUNSHADE MOTOR ASSEMBLY : Diagnosis Procedure

INFOID:000000005461861

Regarding Wiring Diagram information, refer to [RF-153. "Wiring Diagram"](#).

## 1. CHECK POWER SUPPLY

1. Turn ignition switch OFF.
2. Disconnect sunshade motor assembly connector.
3. Turn ignition switch ON.
4. Check voltage between sunshade motor assembly harness connector and ground.

(+)		(-)	Voltage (V) (Approx.)
Connector	Terminal		
R102	6	Ground	Battery voltage

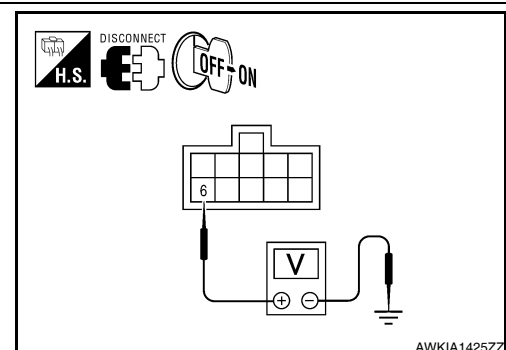

# POWER SUPPLY AND GROUND CIRCUIT

[WITH DUAL PANEL SUNROOF]

## < COMPONENT DIAGNOSIS >

Is the inspection result normal?

- YES >> GO TO 2.
- NO >> GO TO 3.

### 2. CHECK GROUND CIRCUIT

1. Turn ignition switch OFF.
2. Check continuity between sunshade motor assembly harness connector and ground.

Sunshade motor assembly		Ground	Continuity
Connector	Terminal		
R102	1		Yes

Is the inspection result normal?

- YES >> GO TO 4.
- NO >> Repair or replace the harness.

### 3. CHECK SUNSHADE MOTOR CIRCUIT

1. Turn ignition switch OFF.
2. Disconnect BCM connector.
3. Check continuity between BCM harness connector (A) and sunshade motor assembly harness connector (B).

BCM (A)		Sunshade motor assembly (B)		Continuity
Connector	Terminal	Connector	Terminal	
M118	2	R102	6	Yes

4. Check continuity between BCM harness connector and ground.

BCM		Ground	Continuity
Connector	Terminal		
M118	2		No

Is the inspection result normal?

- YES >> Replace BCM. Refer to [BCS-87, "Removal and Installation"](#).
- NO >> Repair or replace the harness.

### 4. CHECK INTERMITTENT INCIDENT

Refer to [GI-39, "Intermittent Incident"](#).

>> Inspection End.

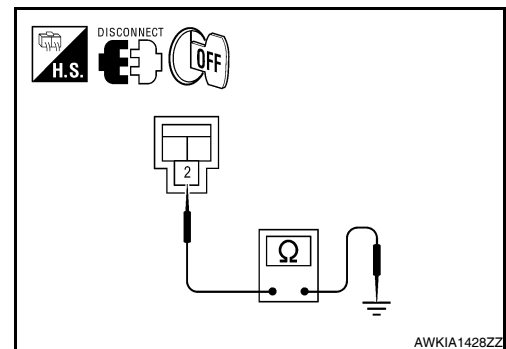
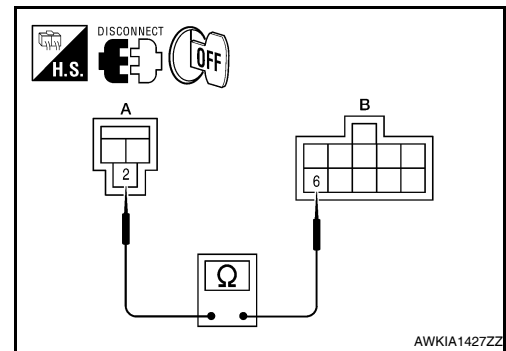
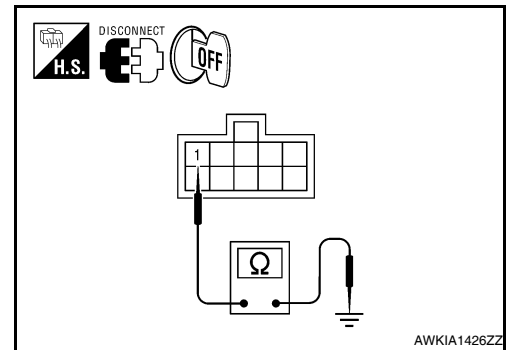

# COMMUNICATION SIGNAL CIRCUIT

< COMPONENT DIAGNOSIS >

[WITH DUAL PANEL SUNROOF]

## COMMUNICATION SIGNAL CIRCUIT

### Description

INFOID:000000005461862

Detects door open/close condition.

### Diagnosis Procedure

INFOID:000000005461863

Regarding Wiring Diagram information, refer to [RF-145, "Wiring Diagram"](#).

### 1. CHECK FRONT DOOR SWITCH INPUT SIGNAL

1. Turn ignition switch OFF.
2. Disconnect sunshade motor assembly connector.
3. Turn ignition switch ON.
4. Check signal between sunshade motor assembly harness connector and ground with oscilloscope.

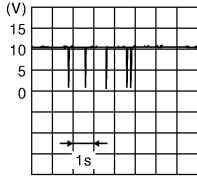
(+)		(-)	Voltage (V) (Approx.)
Sunshade motor assembly			
Connector	Terminal		
R102	7	Ground	 <p style="text-align: right;">JMKIA1869ZZ</p>

Is the inspection result normal?

- YES >> Inspection End.  
NO >> GO TO 2.

### 2. CHECK COMMUNICATION SIGNAL CIRCUIT

1. Turn ignition switch OFF.
2. Disconnect sunroof motor assembly connector.
3. Check continuity between sunshade motor assembly harness connector (A) and sunroof motor assembly harness connector (B).

Sunshade motor assembly (A)		Sunroof motor assembly (B)		Continuity
Connector	Terminal	Connector	Terminal	
R102	7	R101	7	Yes

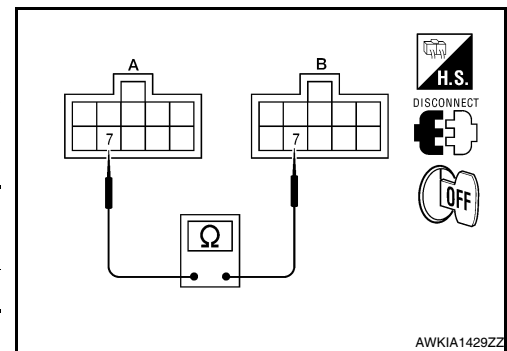

4. Check continuity between sunshade motor assembly harness connector and ground.

Sunshade motor assembly		Ground	Continuity
Connector	Terminal		
R102	7		No

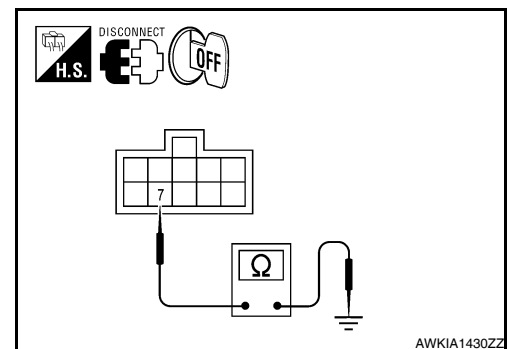

Is the inspection result normal?

- YES >> Replace sunshade motor assembly. Refer to [RF-177, "Removal and Installation"](#).  
NO >> Repair or replace harness.

# SUNROOF SWITCH

< COMPONENT DIAGNOSIS >

[WITH DUAL PANEL SUNROOF]

## SUNROOF SWITCH

### Description

INFOID:000000005461864

Transmits switch operation signal to sunroof motor assembly.

### Diagnosis Procedure

INFOID:000000005461865

Regarding Wiring Diagram information, refer to [RF-145, "Wiring Diagram"](#).

## 1. CHECK SUNROOF SWITCH INPUT SIGNAL

1. Turn ignition switch ON.
2. Check voltage between sunroof motor assembly harness connector and ground.

(+)		(-)	Condition	Voltage (V)
Sunroof motor assembly Connector	Terminals			
R101	4	Ground	Sunroof switch is operated PUSH	0
			Other than above	Battery voltage
	5		Sunroof switch is operated OPEN (1st or 2nd)	0
			Other than above	Battery voltage
	9		Sunroof switch is operated OPEN (2nd) or CLOSE (2nd)	0
			Other than above	Battery voltage
	10		Sunroof switch is operated CLOSE (1st or 2nd)	0
			Other than above	Battery voltage

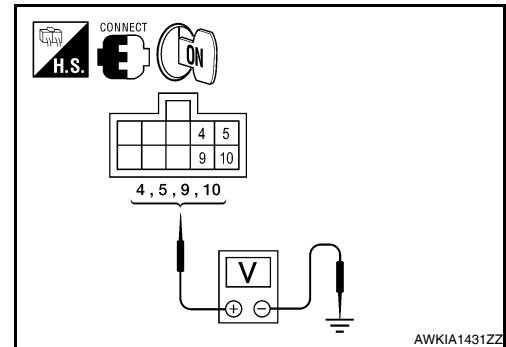

Is the inspection result normal?

YES >> Replace sunroof motor. Refer to [RF-176, "Removal and Installation"](#).

NO >> GO TO 2.

## 2. CHECK SUNROOF SWITCH CIRCUIT

1. Turn ignition switch OFF.
2. Disconnect sunroof motor assembly connector and sunroof switch connector.
3. Check continuity between sunroof motor assembly harness connector (A) and sunroof switch harness connector (B).

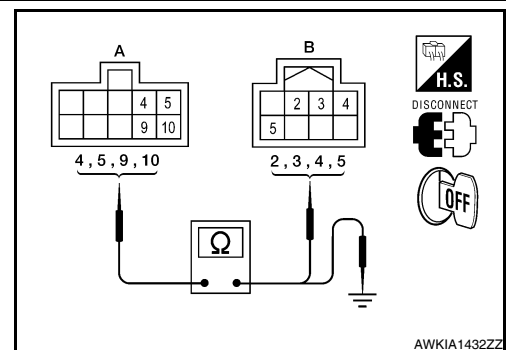

# SUNROOF SWITCH

< COMPONENT DIAGNOSIS >

[WITH DUAL PANEL SUNROOF]

Sunroof motor assembly (A)		Sunroof switch (B)		Continuity
Connector	Terminal	Connector	Terminal	
R101	4	R14	5	Yes
	5		3	
	9		2	
	10		4	

4. Check continuity between sunroof motor assembly harness connector and ground.

Sunroof motor assembly		Ground	Continuity
Connector	Terminal		
R101	4	Ground	No
	5		
	9		
	10		

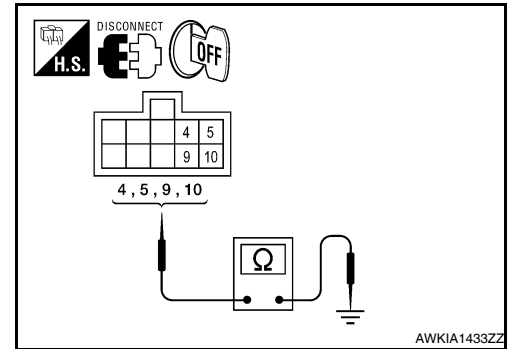

Is the inspection result normal?

- YES >> GO TO 3.
- NO >> Repair or the replace harness.

### 3.CHECK SUNROOF SWITCH GROUND CIRCUIT

Check continuity between sunroof switch harness connector and ground.

Sunroof switch		Ground	Continuity
Connector	Terminal		
R14	1	Ground	Yes

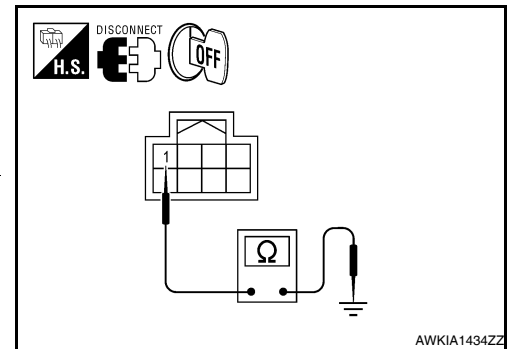

Is the inspection result normal?

- YES >> GO TO 4.
- NO >> Repair or replace the harness.

### 4.CHECK SUNROOF SWITCH

Check sunroof switch.  
Refer to [RF-101, "Component Inspection"](#).

Is the inspection result normal?

- YES >> GO TO 5.
- NO >> Replace sunroof switch. Refer to [RF-195, "Removal and Installation"](#).

### 5.CHECK INTERMITTENT INCIDENT

Refer to [GI-39, "Intermittent Incident"](#).

>> Inspection End.

## Component Inspection

INFOID:000000005461866

## SUNROOF SWITCH

### 1.CHECK SUNROOF SWITCH

# SUNROOF SWITCH

[WITH DUAL PANEL SUNROOF]

## < COMPONENT DIAGNOSIS >

1. Turn ignition switch OFF.
2. Disconnect sunroof switch connector.
3. Check continuity sunroof switch terminals.

Terminals	Condition	Continuity
2	Sunroof switch is operated OPEN (2nd) or CLOSE (2nd)	Yes
	Other than above	No
3	Sunroof switch is operated OPEN (1st) or OPEN (2nd)	Yes
	Other than above	No
4	Sunroof switch is operated CLOSE (1st) or CLOSE (2nd)	Yes
	Other than above	No
5	Sunroof switch is operated PUSH	Yes
	Other than above	No

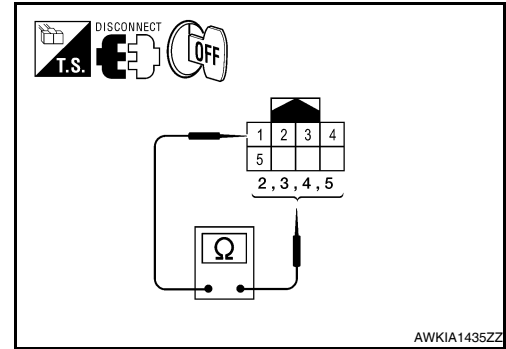

AWKIA1435ZZ

### Is the inspection result normal?

- YES >> Inspection End.  
 NO >> Replace sunroof switch. Refer to [RF-195, "Removal and Installation"](#).

# DOOR SWITCH

< COMPONENT DIAGNOSIS >

[WITH DUAL PANEL SUNROOF]

## DOOR SWITCH

### Description

INFOID:000000005461867

Detects door open/close condition.

### Component Function Check

INFOID:000000005461868

### 1.CHECK FUNCTION

#### With CONSULT-III

Check door switches DOOR SW-DR, DOOR SW-AS in Data Monitor mode with CONSULT-III.

Monitor item	Condition
DOOR SW-DR	CLOSE → OPEN: OFF → ON
DOOR SW-AS	

#### Is the inspection result normal?

- YES >> Door switch is OK.
- NO >> Refer to [RF-103, "Diagnosis Procedure"](#).

### Diagnosis Procedure

INFOID:000000005461869

Regarding Wiring Diagram information, refer to [RF-145, "Wiring Diagram"](#).

### 1.CHECK DOOR SWITCH INPUT SIGNAL

1. Turn ignition switch OFF.
2. Check signal between BCM connector and ground with oscilloscope.

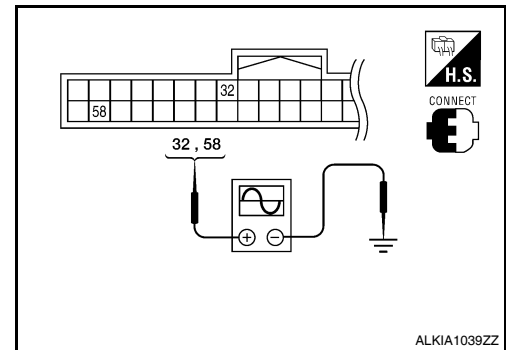

# DOOR SWITCH

< COMPONENT DIAGNOSIS >

[WITH DUAL PANEL SUNROOF]

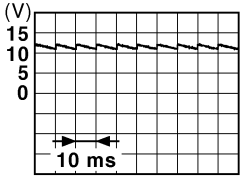
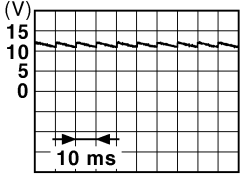
Terminals		(-)	Door condition	Voltage (V) (Approx.)
(+)				
BCM connector	Terminal			
A: M18	58	Ground	OPEN	0
			CLOSE	 <p style="text-align: right; font-size: small;">JPMA0011GB</p>
	OPEN		0	
	CLOSE		 <p style="text-align: right; font-size: small;">JPMA0011GB</p>	
32		Passenger side		

Is the inspection result normal?

- YES >> GO TO 4
- NO >> GO TO 2

## 2. CHECK DOOR SWITCH CIRCUIT

1. Disconnect BCM connector.
2. Check continuity between BCM connector and door switch connector.

BCM connector	Terminal	Door switch connector	Terminal	Continuity
A: M18	58	C: B8 (Driver side)	2	Yes
	32	C: B108 (Passenger side)		

3. Check continuity between BCM connector and ground.

BCM connector	Terminal	Ground	Continuity
A: M18	58		
	32		

Is the inspection result normal?

- YES >> GO TO 3
- NO >> Repair or replace harness between BCM and door switch.

## 3. CHECK DOOR SWITCH

Refer to [RF-105, "Component Inspection"](#).

Is the inspection result normal?

- YES >> GO TO 4
- NO >> Replace malfunctioning door switch.

## 4. CHECK INTERMITTENT INCIDENT

Refer to [GI-39, "Intermittent Incident"](#).

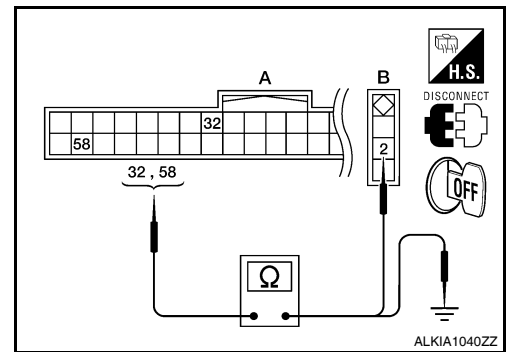



# DOOR SWITCH

< COMPONENT DIAGNOSIS >

[WITH DUAL PANEL SUNROOF]

>> Inspection End.

## Component Inspection

INFOID:000000005461870

### 1. CHECK DOOR SWITCH

1. Turn ignition switch OFF.
2. Disconnect door switch connector.
3. Check door switch.

Terminal		Door switch condition	Continuity
Door switch			
2	Ground part of door switch	Pressed	No
		Released	Yes

Is the inspection result normal?

- YES >> Inspection End.  
NO >> Replace malfunctioning door switch.

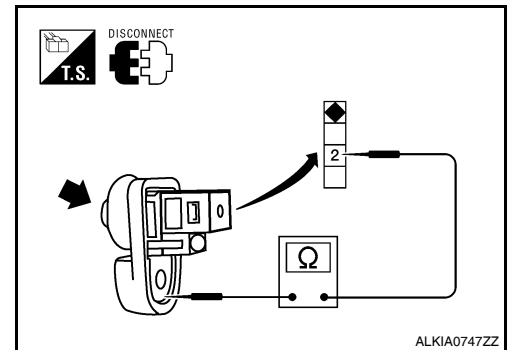

A  
B  
C  
D  
E  
F  
G  
H  
I  
J  
RF  
L  
M  
N  
O  
P

# BCM (BODY CONTROL MODULE)

< ECU DIAGNOSIS >

[WITH DUAL PANEL SUNROOF]

## ECU DIAGNOSIS

### BCM (BODY CONTROL MODULE)

Reference Value

INFOID:00000000511869

#### VALUES ON THE DIAGNOSIS TOOL

Monitor Item	Condition	Value/Status
FR WIPER HI	Other than front wiper switch HI	OFF
	Front wiper switch HI	ON
FR WIPER LOW	Other than front wiper switch LO	OFF
	Front wiper switch LO	ON
FR WASHER SW	Front washer switch OFF	OFF
	Front washer switch ON	ON
FR WIPER INT	Other than front wiper switch INT	OFF
	Front wiper switch INT	ON
FR WIPER STOP	Front wiper is not in STOP position	OFF
	Front wiper is in STOP position	ON
INT VOLUME	Wiper intermittent dial is in a dial position 1 - 7	Wiper intermittent dial position
TURN SIGNAL R	Other than turn signal switch RH	OFF
	Turn signal switch RH	ON
TURN SIGNAL L	Other than turn signal switch LH	OFF
	Turn signal switch LH	ON
TAIL LAMP SW	Other than lighting switch 1ST and 2ND	OFF
	Lighting switch 1ST or 2ND	ON
HI BEAM SW	Other than lighting switch HI	OFF
	Lighting switch HI	ON
HEAD LAMP SW 1	Other than lighting switch 2ND	OFF
	Lighting switch 2ND	ON
HEAD LAMP SW 2	Other than lighting switch 2ND	OFF
	Lighting switch 2ND	ON
PASSING SW	Other than lighting switch PASS	OFF
	Lighting switch PASS	ON
AUTO LIGHT SW	Other than lighting switch AUTO	OFF
	Lighting switch AUTO	ON
FR FOG SW	Front fog lamp switch OFF	OFF
	Front fog lamp switch ON	ON
DOOR SW-DR	Driver door closed	OFF
	Driver door opened	ON
DOOR SW-AS	Passenger door closed	OFF
	Passenger door opened	ON
DOOR SW-RR	Rear door RH closed	OFF
	Rear door RH opened	ON
DOOR SW-RL	Rear door LH closed	OFF
	Rear door LH opened	ON

# BCM (BODY CONTROL MODULE)

< ECU DIAGNOSIS >

[WITH DUAL PANEL SUNROOF]

Monitor Item	Condition	Value/Status	
CDL LOCK SW	Other than power door lock switch LOCK	OFF	A
	Power door lock switch LOCK	ON	
CDL UNLOCK SW	Other than power door lock switch UNLOCK	OFF	B
	Power door lock switch UNLOCK	ON	
KEY CYL LK-SW	Other than driver door key cylinder LOCK position	OFF	C
	Driver door key cylinder LOCK position	ON	
KEY CYL UN-SW	Other than driver door key cylinder UNLOCK position	OFF	D
	Driver door key cylinder UNLOCK position	ON	
HAZARD SW	When hazard switch is not pressed	OFF	E
	When hazard switch is pressed	ON	
REAR DEF SW	When rear window defogger switch is pressed	ON	
TR CANCEL SW	Trunk lid opener cancel switch OFF	OFF	F
	Trunk lid opener cancel switch ON	ON	
TR/BD OPEN SW	Trunk lid opener switch OFF	OFF	G
	While the trunk lid opener switch is turned ON	ON	
TRNK/HAT MNTR	Trunk lid closed	OFF	H
	Trunk lid opened	ON	
RKE-LOCK	When LOCK button of Intelligent Key is not pressed	OFF	I
	When LOCK button of Intelligent Key is pressed	ON	
RKE-UNLOCK	When UNLOCK button of Intelligent Key is not pressed	OFF	J
	When UNLOCK button of Intelligent Key is pressed	ON	
RKE-TR/BD	When TRUNK OPEN button of Intelligent Key is not pressed	OFF	
	When TRUNK OPEN button of Intelligent Key is pressed	ON	
RKE-PANIC	When PANIC button of Intelligent Key is not pressed	OFF	
	When PANIC button of Intelligent Key is pressed	ON	
RKE-P/W OPEN	When UNLOCK button of Intelligent Key is not pressed and held	OFF	RF
	When UNLOCK button of Intelligent Key is pressed and held	ON	
RKE-MODE CHG	When LOCK/UNLOCK button of Intelligent Key is not pressed and held simultaneously	OFF	L
	When LOCK/UNLOCK button of Intelligent Key is pressed and held simultaneously	ON	
OPTICAL SENSOR	When outside of the vehicle is bright	Close to 5 V	M
	When outside of the vehicle is dark	Close to 0 V	
REQ SW-DR	When front door request switch is not pressed (driver side)	OFF	N
	When front door request switch is pressed (driver side)	ON	
REQ SW-AS	When front door request switch is not pressed (passenger side)	OFF	O
	When front door request switch is pressed (passenger side)	ON	
REQ SW-RL	When rear door request switch is not pressed (driver side)	OFF	P
	When rear door request switch is pressed (driver side)	ON	
REQ SW-RR	When rear door request switch is not pressed (passenger side)	OFF	
	When rear door request switch is pressed (passenger side)	ON	
REQ SW-BD/TR	When trunk request switch is not pressed	OFF	
	When trunk request switch is pressed	ON	
PUSH SW	When engine switch (push switch) is not pressed	OFF	
	When engine switch (push switch) is pressed	ON	

# BCM (BODY CONTROL MODULE)

< ECU DIAGNOSIS >

[WITH DUAL PANEL SUNROOF]

Monitor Item	Condition	Value/Status
IGN RLY 2-F/B	Ignition switch OFF or ACC	OFF
	Ignition switch ON	ON
ACC RLY-F/B	Ignition switch OFF	OFF
	Ignition switch ACC or ON	ON
BRAKE SW 1	When the brake pedal is not depressed	ON
	When the brake pedal is depressed	OFF
DETE/CANCL SW	When selector lever is in P position	OFF
	When selector lever is in any position other than P	ON
SFT PN/N SW	When selector lever is in any position other than P or N	OFF
	When selector lever is in P or N position	ON
S/L-LOCK*	Electronic steering column lock LOCK status	OFF
	Electronic steering column lock UNLOCK status	ON
S/L-UNLOCK*	Electronic steering column lock UNLOCK status	OFF
	Electronic steering column lock LOCK status	ON
S/L RELAY-F/B*	Ignition switch OFF or ACC	OFF
	Ignition switch ON	ON
UNLK SEN-DR	Driver door UNLOCK status	OFF
	Driver door LOCK status	ON
PUSH SW-IPDM	When engine switch (push switch) is not pressed	OFF
	When engine switch (push switch) is pressed	ON
IGN RLY1 F/B	Ignition switch OFF or ACC	OFF
	Ignition switch ON	ON
DETE SW -IPDM	When selector lever is in P position	OFF
	When selector lever is in any position other than P	ON
SFT PN -IPDM	When selector lever is in any position other than P or N	OFF
	When selector lever is in P or N position	ON
SFT P-MET	When selector lever is in any position other than P	OFF
	When selector lever is in P position	ON
SFT N-MET	When selector lever is in any position other than N	OFF
	When selector lever is in N position	ON
ENGINE STATE	Engine stopped	STOP
	While the engine stalls	STALL
	At engine cranking	CRANK
	Engine running	RUN
S/L LOCK-IPDM*	Electronic steering column lock LOCK status	OFF
	Electronic steering column lock UNLOCK status	ON
S/L UNLK-IPDM*	Electronic steering column lock UNLOCK status	OFF
	Electronic steering column lock LOCK status	ON
S/L RELAY-REQ*	Ignition switch OFF or ACC	OFF
	Ignition switch ON	ON
VEH SPEED 1	While driving	Equivalent to speedometer reading
VEH SPEED 2	While driving	Equivalent to speedometer reading

# BCM (BODY CONTROL MODULE)

< ECU DIAGNOSIS >

[WITH DUAL PANEL SUNROOF]

Monitor Item	Condition	Value/Status	
DOOR STAT-DR	Driver door LOCK status	LOCK	A
	Wait with selective UNLOCK operation (5 seconds)	READY	
	Driver door UNLOCK status	UNLK	B
DOOR STAT-AS	Passenger door LOCK status	LOCK	
	Wait with selective UNLOCK operation (5 seconds)	READY	C
	Passenger door UNLOCK status	UNLK	
ID OK FLAG	Ignition switch ACC or ON	RESET	
	Ignition switch OFF	SET	D
PRMT ENG STRT	When the engine start is prohibited	RESET	
	When the engine start is permitted	SET	
KEY SW -SLOT	When Intelligent Key is not inserted into key slot	OFF	E
	When Intelligent Key is inserted into key slot	ON	
RKE OPE COUN1	During the operation of Intelligent Key	Operation frequency of Intelligent Key	F
CONFRM ID ALL	The key ID that the key slot receives does not accord with any key ID registered to BCM.	YET	
	The key ID that the key slot receives accords with any key ID registered to BCM.	DONE	G
CONFIRM ID4	The key ID that the key slot receives does not accord with the fourth key ID registered to BCM.	YET	
	The key ID that the key slot receives accords with the fourth key ID registered to BCM.	DONE	H
CONFIRM ID3	The key ID that the key slot receives does not accord with the third key ID registered to BCM.	YET	I
	The key ID that the key slot receives accords with the third key ID registered to BCM.	DONE	
CONFIRM ID2	The key ID that the key slot receives does not accord with the second key ID registered to BCM.	YET	J
	The key ID that the key slot receives accords with the second key ID registered to BCM.	DONE	RF
CONFIRM ID1	The key ID that the key slot receives does not accord with the first key ID registered to BCM.	YET	
	The key ID that the key slot receives accords with the first key ID registered to BCM.	DONE	L
TP 4	The ID of fourth key is not registered to BCM	YET	
	The ID of fourth key is registered to BCM	DONE	M
TP 3	The ID of third key is not registered to BCM	YET	
	The ID of third key is registered to BCM	DONE	N
TP 2	The ID of second key is not registered to BCM	YET	
	The ID of second key is registered to BCM	DONE	
TP 1	The ID of first key is not registered to BCM	YET	O
	The ID of first key is registered to BCM	DONE	
AIR PRESS FL	Ignition switch ON (only when the signal from the transmitter is received)	Air pressure of front LH tire	P
AIR PRESS FR	Ignition switch ON (only when the signal from the transmitter is received)	Air pressure of front RH tire	
AIR PRESS RR	Ignition switch ON (only when the signal from the transmitter is received)	Air pressure of rear RH tire	
AIR PRESS RL	Ignition switch ON (only when the signal from the transmitter is received)	Air pressure of rear LH tire	

# BCM (BODY CONTROL MODULE)

< ECU DIAGNOSIS >

[WITH DUAL PANEL SUNROOF]

Monitor Item	Condition	Value/Status
ID REGST FL1	When ID of front LH tire transmitter is registered	DONE
	When ID of front LH tire transmitter is not registered	YET
ID REGST FR1	When ID of front RH tire transmitter is registered	DONE
	When ID of front RH tire transmitter is not registered	YET
ID REGST RR1	When ID of rear RH tire transmitter is registered	DONE
	When ID of rear RH tire transmitter is not registered	YET
ID REGST RL1	When ID of rear LH tire transmitter is registered	DONE
	When ID of rear LH tire transmitter is not registered	YET
WARNING LAMP	Tire pressure indicator OFF	OFF
	Tire pressure indicator ON	ON
BUZZER	Tire pressure warning alarm is not sounding	OFF
	Tire pressure warning alarm is sounding	ON

\* : With electronic steering column lock

# BCM (BODY CONTROL MODULE)

[WITH DUAL PANEL SUNROOF]

< ECU DIAGNOSIS >

## Terminal Layout

INFOID:000000005511870

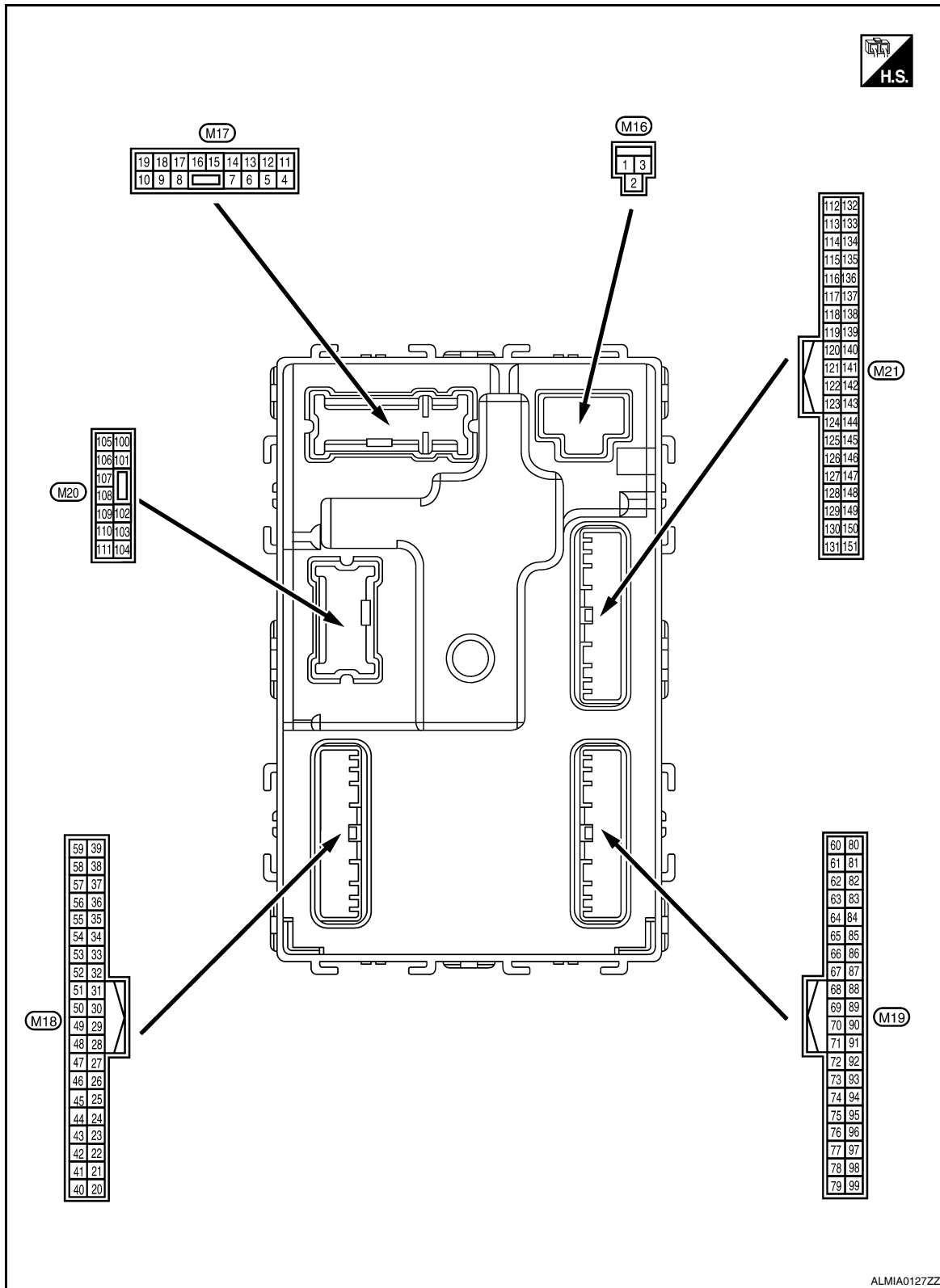

A  
B  
C  
D  
E  
F  
G  
H  
I  
J  
RF  
L  
M  
N  
O  
P

## Physical Values

INFOID:000000005511871

# BCM (BODY CONTROL MODULE)

< ECU DIAGNOSIS >

[WITH DUAL PANEL SUNROOF]

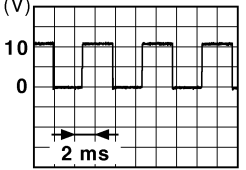
Terminal No. (Wire color)		Description		Condition		Value (Approx.)
		Signal name	Input/ Output			
(+)	(-)					
1 (W/B)	Ground	Battery power supply	Input	Ignition switch OFF		Battery voltage
2 (R/Y)	Ground	Battery power supply output	Output	Ignition switch OFF		Battery voltage
3 (L/W)	Ground	Ignition power supply output	Output	Ignition switch ON		Battery voltage
4 (P/W)	Ground	Interior room lamp power supply	Output	After passing the interior room lamp battery saver operation time		0V
				Any other time after passing the interior room lamp battery saver operation time		Battery voltage
5 (G)	Ground	Front door RH UNLOCK	Output	Front door RH	UNLOCK (actuator is activated)	Battery voltage
					Other than UNLOCK (actuator is not activated)	0V
7 (R/W)	Ground	Step lamp	Output	Step lamp	ON	0V
					OFF	Battery voltage
8 (V)	Ground	All doors LOCK	Output	All doors	LOCK (actuator is activated)	Battery voltage
					Other than LOCK (actuator is not activated)	0V
9 (L)	Ground	Front door LH UNLOCK	Output	Front door LH	UNLOCK (actuator is activated)	Battery voltage
					Other than UNLOCK (actuator is not activated)	0V
10 (G)	Ground	Rear door RH and rear door LH UNLOCK	Output	Rear door RH and rear door LH	UNLOCK (actuator is activated)	Battery voltage
					Other than UNLOCK (actuator is not activated)	0V
11 (Y/R)	Ground	Battery power supply	Input	Ignition switch OFF		Battery voltage
13 (B)	Ground	Ground	—	Ignition switch ON		0V
14 (GR/W)	Ground	Engine switch (push switch) illumination ground	Input	Tail lamp	OFF	0V
					ON	<b>NOTE:</b> When the illumination brightening/dimming level is in the neutral position 
15 (Y/L)	Ground	ACC indicator lamp	Output	Ignition switch	OFF	Battery voltage
					ACC or ON	0V

JSNIA0010GB



# BCM (BODY CONTROL MODULE)

< ECU DIAGNOSIS >

[WITH DUAL PANEL SUNROOF]

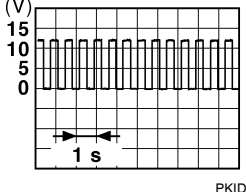
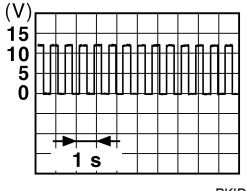
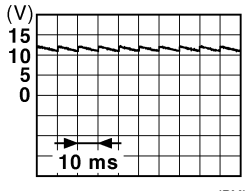
Terminal No. (Wire color)		Description		Condition		Value (Approx.)
(+)	(-)	Signal name	Input/ Output			
17 (G/B)	Ground	Turn signal (RH)	Output	Ignition switch ON	Turn signal switch OFF	0V
					Turn signal switch RH	
18 (G/Y)	Ground	Turn signal (LH)	Output	Ignition switch ON	Turn signal switch OFF	0V
					Turn signal switch LH	
19 (Y)	Ground	Room lamp timer control	Output	Interior room lamp	OFF	Battery voltage
					ON	0V
21 (P/B)	Ground	Optical sensor signal	Input	Ignition switch ON	When outside of the vehi- cle is bright	Close to 5V
					When outside of the vehi- cle is dark	Close to 0V
24 (R/W)	Ground	Stop lamp switch 1	Input	—	Battery voltage	
26 (O/L)	Ground	Stop lamp switch 2	Input	Stop lamp switch	OFF (brake pedal is re- leased)	0V
					ON (brake pedal is de- pressed)	Battery voltage
27 (O)	Ground	Front door lock as- sembly LH (unlock sensor)	Input	Front door LH	LOCK status	
					UNLOCK status	0V
29 (Y)	Ground	Key slot switch	Input	When Intelligent Key is inserted into key slot	Battery voltage	
				When Intelligent Key is not inserted into key slot	0V	
30 (V/Y)	Ground	ACC feedback signal	Input	Ignition switch	OFF	0
				ACC or ON	Battery voltage	
31 (G)	Ground	Rear window defog- ger feedback signal	Input	Rear window de- fogger switch	OFF	0V
				ON	Battery voltage	



A  
B  
C  
D  
E  
F  
G  
H  
I  
J  
L  
M  
N  
O  
P

RF

# BCM (BODY CONTROL MODULE)

< ECU DIAGNOSIS >

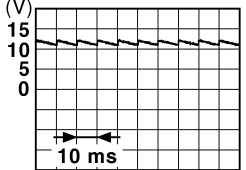
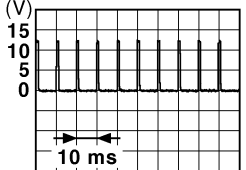
[WITH DUAL PANEL SUNROOF]

Terminal No. (Wire color)		Description		Condition		Value (Approx.)
(+)	(-)	Signal name	Input/ Output			
32 (R/B)	Ground	Front door RH switch	Input	Front door RH switch	OFF (when front door RH closes)	 <small>JPMIA0011GB</small> 11.8 V
					ON (when front door RH opens)	0V
37 (O)	Ground	Trunk lid opener cancel switch	Input	Trunk lid opener cancel switch	CANCEL	 <small>JPMIA0012GB</small> 1.1V
					ON	0V
38 (GR/W)	Ground	Rear window defogger ON signal	Input	Rear window defogger switch	OFF	5V
					ON	0V
40 (Y/G)	Ground	Power window serial link	Input/ Output	Ignition switch ON	Ignition switch ON	 <small>JPMIA0013GB</small> 10.2V
					Ignition switch OFF or ACC	0V
41 (W)	Ground	Engine switch (push switch) illumination	Output	Engine switch (push switch) illumination	ON	5.5V
					OFF	0V
42 (R)	Ground	LOCK indicator lamp	Output	LOCK indicator lamp	ON	0V
					OFF	Battery voltage
45 (P)	Ground	Receiver & sensor ground	Input	Ignition switch ON		0V
46 (V/W)	Ground	Receiver & sensor power supply output	Output	Ignition switch	OFF	0V
					ACC or ON	5.0V

# BCM (BODY CONTROL MODULE)

< ECU DIAGNOSIS >

[WITH DUAL PANEL SUNROOF]

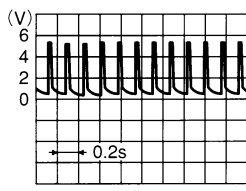
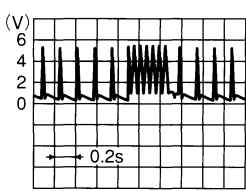
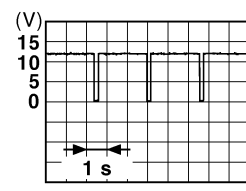
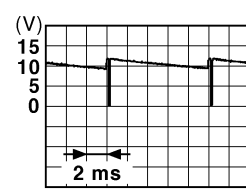
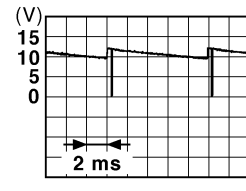
Terminal No. (Wire color)		Description		Condition	Value (Approx.)
(+)	(-)	Signal name	Input/ Output		
47 <sup>1</sup> (G/O)	Ground	Tire pressure receiver signal	Input/ Output	Ignition switch ON	Standby state  
				When receiving the signal from the transmitter  	
48 (R/G)	Ground	Selector lever transmission range switch signal	Input	Selector lever	P or N position 12.0V
				Except P and N positions	0V
49 (L/O)	Ground	Security indicator signal	Output	Security indicator	ON 0V
				Blinking  	11.3V
50 (LG/B)	Ground	Combination switch OUTPUT 5	Output	Combination switch (Wiper intermittent dial 4)	All switch OFF 0V
				Lighting switch 1ST	10.7V  
				Lighting switch high-beam	
				Lighting switch 2ND	
Turn signal switch RH	Turn signal switch RH				
51 (L/W)	Ground	Combination switch OUTPUT 1	Output	Combination switch	All switch OFF (Wiper intermittent dial 4) 0V
				Any of the conditions below with all switch OFF • Wiper intermittent dial 1 • Wiper intermittent dial 2 • Wiper intermittent dial 3 • Wiper intermittent dial 6 • Wiper intermittent dial 7	10.7V  

A  
B  
C  
D  
E  
F  
G  
H  
I  
J  
K  
L  
M  
N  
O  
P

RF

# BCM (BODY CONTROL MODULE)

[WITH DUAL PANEL SUNROOF]

< ECU DIAGNOSIS >

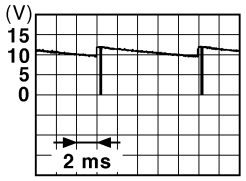
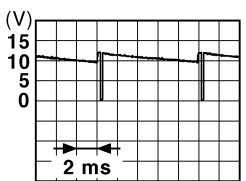
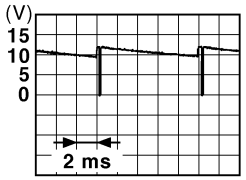
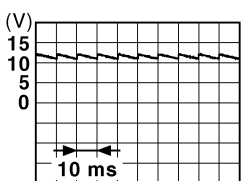
Terminal No. (Wire color)		Description		Condition	Value (Approx.)	
		Signal name	Input/ Output			
(+)	(-)					
52 (G/B)	Ground	Combination switch OUTPUT 2	Output	Combination switch	All switch OFF (Wiper intermittent dial 4)	0V
					Front washer switch ON (Wiper intermittent dial 4)	 <p style="text-align: right; font-size: small;">JPMIA0033GB</p>
					10.7V	
53 (LG/ R)	Ground	Combination switch OUTPUT 3	Output	Combination switch (Wiper intermit- tent dial 4)	All switch OFF	 <p style="text-align: right; font-size: small;">JPMIA0034GB</p>
					Front wiper switch INT	
					Front wiper switch LO	
					Lighting switch AUTO	
					10.7V	
54 (G/Y)	Ground	Combination switch OUTPUT 4	Output	Combination switch (Wiper intermit- tent dial 4)	All switch OFF	 <p style="text-align: right; font-size: small;">JPMIA0035GB</p>
					Front fog lamp switch ON	
					Lighting switch 2ND	
					Lighting switch flash-to- pass	
					10.7V	
57 <sup>1</sup> (W)	Ground	Tire pressure warn- ing check switch	Input	—	5V	
58 (SB)	Ground	Front door LH switch	Input	Front door LH switch	OFF (front door LH CLOSE)	 <p style="text-align: right; font-size: small;">JPMIA0011GB</p>
					ON (front door LH OPEN)	
59 (G/R)	Ground	Rear window defog- ger relay	Output	Rear window de- fogger	Active	Battery voltage
				Not activated	0V	

# BCM (BODY CONTROL MODULE)

< ECU DIAGNOSIS >

[WITH DUAL PANEL SUNROOF]

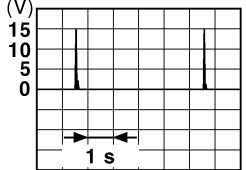
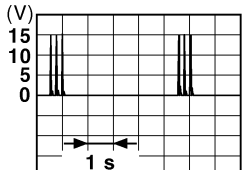
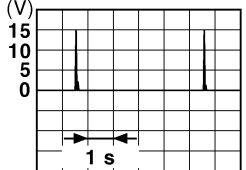
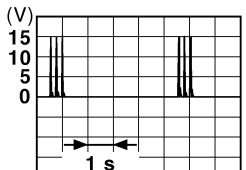
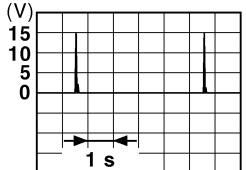
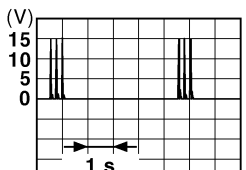
Terminal No. (Wire color)		Description		Condition	Value (Approx.)
(+)	(-)	Signal name	Input/ Output		
60 (B/R)	Ground	Front console antenna 2 (-)	Output	Ignition switch OFF	 <p style="text-align: right; font-size: small;">JMKIA0062GB</p>
				When Intelligent Key is not in the passenger compartment	 <p style="text-align: right; font-size: small;">JMKIA0063GB</p>
61 (W/R)	Ground	Center console antenna 2 (+)	Output	Ignition switch OFF	 <p style="text-align: right; font-size: small;">JMKIA0062GB</p>
				When Intelligent Key is not in the passenger compartment	 <p style="text-align: right; font-size: small;">JMKIA0063GB</p>
62 (V)	Ground	Front outside handle RH antenna (-)	Output	When the front door RH request switch is operated with ignition switch OFF	 <p style="text-align: right; font-size: small;">JMKIA0062GB</p>
				When Intelligent Key is not in the antenna detection area	 <p style="text-align: right; font-size: small;">JMKIA0063GB</p>

A  
B  
C  
D  
E  
F  
G  
H  
I  
J  
L  
M  
N  
O  
P

RF

# BCM (BODY CONTROL MODULE)

[WITH DUAL PANEL SUNROOF]

< ECU DIAGNOSIS >

Terminal No. (Wire color)		Description		Condition	Value (Approx.)
(+)	(-)	Signal name	Input/ Output		
63 (P)	Ground	Front outside handle RH antenna (+)	Output	When the front door RH request switch is operat- ed with ignition switch OFF	When Intelligent Key is in the antenna detection area
				When Intelligent Key is not in the antenna detection area	When Intelligent Key is in the antenna detection area
64 (V)	Ground	Front outside handle LH antenna (-)	Output	When the front door LH request switch is operat- ed with ignition switch OFF	When Intelligent Key is in the antenna detection area
				When Intelligent Key is not in the antenna detection area	When Intelligent Key is not in the antenna detection area
65 (P)	Ground	Front outside handle LH antenna (+)	Output	When the front door LH request switch is operat- ed with ignition switch OFF	When Intelligent Key is in the antenna detection area
				When Intelligent Key is not in the antenna detection area	When Intelligent Key is not in the antenna detection area

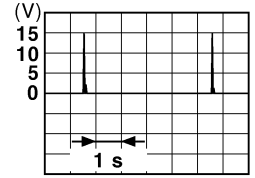

JMKIA0062GB

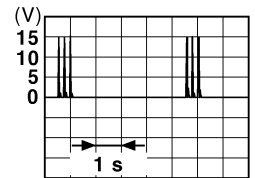

JMKIA0063GB

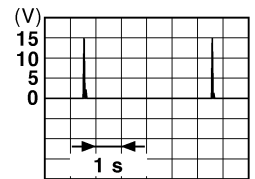

JMKIA0062GB

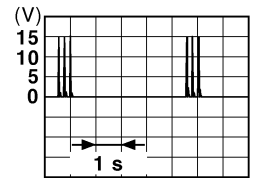

JMKIA0063GB

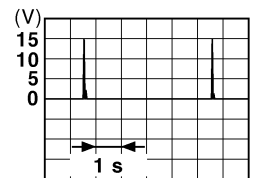

JMKIA0062GB

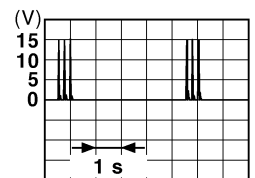

JMKIA0063GB

# BCM (BODY CONTROL MODULE)

< ECU DIAGNOSIS >

[WITH DUAL PANEL SUNROOF]

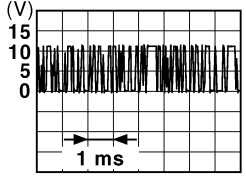
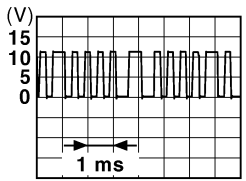
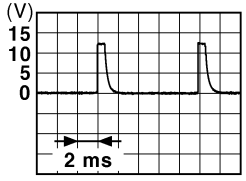
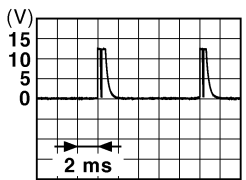
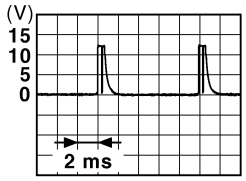

Terminal No. (Wire color)		Description		Condition	Value (Approx.)	
		Signal name	Input/ Output			
(+)	(-)					
68 (G/O)	Ground	NATS antenna amp (built in key slot)	Input/ Output	During waiting	Ignition switch is pressed while inserting the Intelligent Key into the key slot.	Just after pressing ignition switch. Pointer of tester should move.
69 (O)	Ground	NATS antenna amp (built in key slot)	Input/ Output	During waiting	Ignition switch is pressed while inserting the Intelligent Key into the key slot.	Just after pressing ignition switch. Pointer of tester should move.
70 (R/B)	Ground	Ignition relay-2 control	Output	Ignition switch	OFF or ACC	0V
					ON	Battery voltage
71 (L/O)	Ground	Remote keyless entry receiver signal	Input/ Output	During waiting		 <p style="text-align: right; font-size: small;">JMKIA0064GB</p>
				When operating either button on Intelligent Key		 <p style="text-align: right; font-size: small;">JMKIA0065GB</p>
75 (R/Y)	Ground	Combination switch INPUT 5	Input	Combination switch	All switch OFF (Wiper intermittent dial 4)	 <p style="text-align: right; font-size: small;">JPMIA0041GB</p> <p style="text-align: center;">1.4V</p>
					Front fog lamp switch ON (Wiper intermittent dial 4)	 <p style="text-align: right; font-size: small;">JPMIA0037GB</p> <p style="text-align: center;">1.3V</p>
					Any of the conditions below with all switch OFF <ul style="list-style-type: none"> <li>• Wiper intermittent dial 1</li> <li>• Wiper intermittent dial 2</li> <li>• Wiper intermittent dial 6</li> <li>• Wiper intermittent dial 7</li> </ul>	 <p style="text-align: right; font-size: small;">JPMIA0040GB</p> <p style="text-align: center;">1.3V</p>

A  
B  
C  
D  
E  
F  
G  
H  
I  
J  
RF  
L  
M  
N  
O  
P

# BCM (BODY CONTROL MODULE)

< ECU DIAGNOSIS >

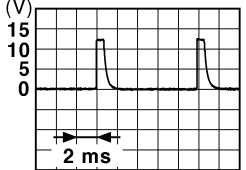
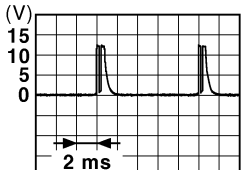
[WITH DUAL PANEL SUNROOF]

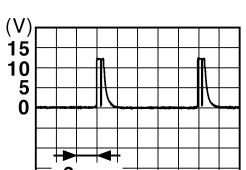
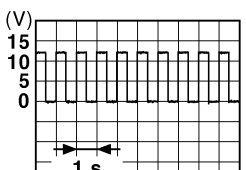
Terminal No. (Wire color)		Description		Condition	Value (Approx.)	
(+)	(-)	Signal name	Input/ Output			
76 (R/G)	Ground	Combination switch INPUT 3	Input	Combination switch	All switch OFF (Wiper intermittent dial 4)	 1.4V
					Lighting switch high-beam (Wiper intermittent dial 4)	 1.3V
					Lighting switch 2ND (Wiper intermittent dial 4)	 1.3V
					Any of the conditions below with all switch OFF • Wiper intermittent dial 1 • Wiper intermittent dial 2 • Wiper intermittent dial 3	 1.3V
77 <sup>2</sup> (BR)	Ground	Engine switch (push switch)	Input	Engine switch (push switch)	Pressed Not pressed	0V Battery voltage
78 (P)	Ground	CAN-L	Input/ Output	—	—	—
79 (L)	Ground	CAN-H	Input/ Output	—	—	—
80 (R/L)	Ground	Key slot illumination	Output	Key slot illumina- tion	OFF	0V
					Blinking	 6.5V
					ON	Battery voltage



# BCM (BODY CONTROL MODULE)

< ECU DIAGNOSIS >

[WITH DUAL PANEL SUNROOF]

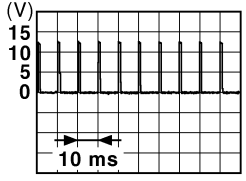
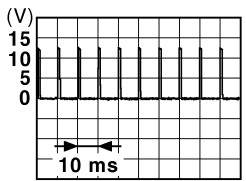

Terminal No. (Wire color)		Description		Condition		Value (Approx.)
		Signal name	Input/ Output			
(+)	(-)					
81 (LG)	Ground	ON indicator lamp	Output	Ignition switch	OFF or ACC	0V
					ON	Battery voltage
83 (L)	Ground	ACC relay control	Output	Ignition switch	OFF	0V
					ACC or ON	Battery voltage
84 (Y/R)	Ground	CVT shift selector	Output	—		Battery voltage
85 <sup>3</sup> (L/O)	Ground	Electronic steering column lock condition No. 1	Input	Electronic steering column lock	Lock status	0V
					Unlock status	Battery voltage
86 <sup>3</sup> (G/R)	Ground	Electronic steering column lock condition No. 2	Input	Electronic steering column lock	Lock status	Battery voltage
					Unlock status	0V
87 (G/B)	Ground	Selector lever P position switch	Input	Selector lever	P position	0V
					Any position other than P	Battery voltage
88 (R)	Ground	Front door RH request switch	Input	Front door RH request switch	ON (pressed)	0V
					OFF (not pressed)	 <p style="text-align: right; font-size: small;">JPMIA0016GB 1.0V</p>
89 (R)	Ground	Front door LH request switch	Input	Front door LH request switch	ON (pressed)	0V
					OFF (not pressed)	 <p style="text-align: right; font-size: small;">JPMIA0016GB 1.0V</p>
90 (Y)	Ground	Blower fan motor relay control	Output	Ignition switch	OFF or ACC	0V
					ON	Battery voltage
91 (L/R)	Ground	Remote keyless entry receiver power supply	Output	Ignition switch OFF		Battery voltage
94 <sup>3</sup> (G/Y)	Ground	Steering wheel lock unit power supply	Output	Ignition switch	OFF or ACC	Battery voltage
					ON	0V

A  
B  
C  
D  
E  
F  
G  
H  
I  
J  
RF  
L  
M  
N  
O  
P

# BCM (BODY CONTROL MODULE)

[WITH DUAL PANEL SUNROOF]

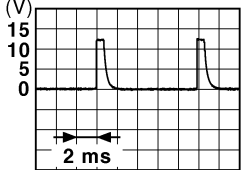
< ECU DIAGNOSIS >

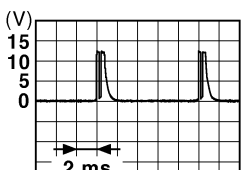
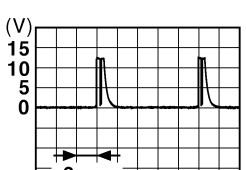
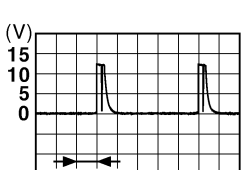
Terminal No. (Wire color)		Description		Condition	Value (Approx.)	
(+)	(-)	Signal name	Input/ Output			
95 (R/W)	Ground	Combination switch INPUT 1	Input	Combination switch (Wiper intermittent dial 4)	All switch OFF	 <p style="text-align: right; margin-right: 20px;">JPMIA0041GB</p> <p style="text-align: center;">1.4V</p>
					Turn signal switch LH	 <p style="text-align: right; margin-right: 20px;">JPMIA0037GB</p> <p style="text-align: center;">1.3V</p>
					Turn signal switch RH	 <p style="text-align: right; margin-right: 20px;">JPMIA0036GB</p> <p style="text-align: center;">1.3V</p>
					Front wiper switch LO	 <p style="text-align: right; margin-right: 20px;">JPMIA0038GB</p> <p style="text-align: center;">1.3V</p>
					Front washer switch ON	 <p style="text-align: right; margin-right: 20px;">JPMIA0039GB</p> <p style="text-align: center;">1.3V</p>

# BCM (BODY CONTROL MODULE)

< ECU DIAGNOSIS >

[WITH DUAL PANEL SUNROOF]

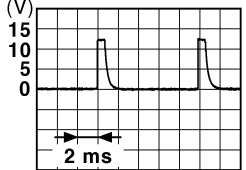
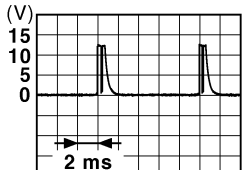
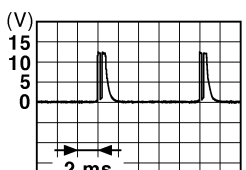
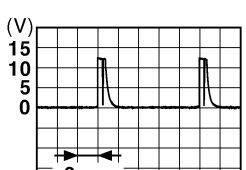
Terminal No. (Wire color)		Description		Condition	Value (Approx.)	
(+)	(-)	Signal name	Input/ Output			
96 (P/B)	Ground	Combination switch INPUT 4	Input	Combination switch	All switch OFF (Wiper intermittent dial 4)	 1.4V
					Lighting switch AUTO (Wiper intermittent dial 4)	 1.3V
					Lighting switch 1ST (Wiper intermittent dial 4)	 1.3V
					Any of the conditions below with all switch OFF	 1.3V
					<ul style="list-style-type: none"> <li>• Wiper intermittent dial 1</li> <li>• Wiper intermittent dial 5</li> <li>• Wiper intermittent dial 6</li> </ul>	

A  
B  
C  
D  
E  
F  
G  
H  
I  
J  
L  
M  
N  
O  
P

RF

# BCM (BODY CONTROL MODULE)

[WITH DUAL PANEL SUNROOF]

< ECU DIAGNOSIS >

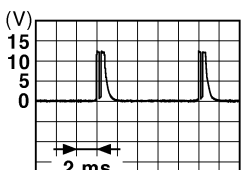
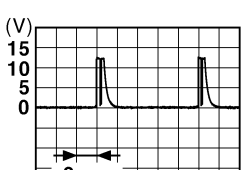
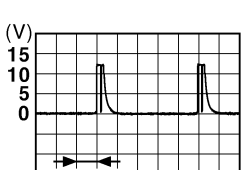
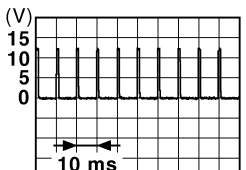
Terminal No. (Wire color)		Description		Condition	Value (Approx.)	
(+)	(-)	Signal name	Input/ Output			
97 (R/B)	Ground	Combination switch INPUT 2	Input			Combination switch (Wiper intermittent dial 4)
				Lighting switch flash-to-pass	 1.3V	
				Lighting switch 2ND	 1.3V	
				Front wiper switch INT	 1.3V	
				Front wiper switch HI	 1.3V	
				Pressed	0 V	
98 (G/O)	Ground	Hazard switch	Input	Hazard switch	Not pressed	 1.1V

# BCM (BODY CONTROL MODULE)

[WITH DUAL PANEL SUNROOF]

< ECU DIAGNOSIS >

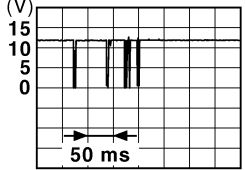
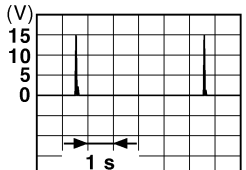
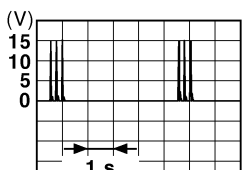
Terminal No. (Wire color)		Description		Condition	Value (Approx.)	
(+)	(-)	Signal name	Input/ Output			
99 <sup>3</sup> (L/Y)	Ground	Electronic steering column lock unit com- munication	Input/ Output	Electronic steer- ing column lock	LOCK status	Battery voltage
					LOCK or UNLOCK	 <p style="text-align: right; font-size: small;">JMKIA0066GB</p>
					For 15 seconds after UN- LOCK	Battery voltage
					15 seconds or later after UNLOCK	0V
103 (V)	Ground	Trunk lid opening.	Output	Trunk lid	Open (trunk lid opener ac- tuator is activated)	Battery voltage
					Close (trunk lid opener ac- tuator is not activated)	0V
110 (V/W)	Ground	Trunk room lamp	Output	Trunk room lamp	ON	0V
					OFF	Battery voltage
114 (B)	Ground	Trunk room antenna 1 (-)	Output	Ignition switch OFF	When Intelligent Key is in the passenger compart- ment	 <p style="text-align: right; font-size: small;">JMKIA0062GB</p>
					When Intelligent Key is not in the passenger compart- ment	 <p style="text-align: right; font-size: small;">JMKIA0063GB</p>

A  
B  
C  
D  
E  
F  
G  
H  
I  
J  
RF  
L  
M  
N  
O  
P

# BCM (BODY CONTROL MODULE)

[WITH DUAL PANEL SUNROOF]

< ECU DIAGNOSIS >

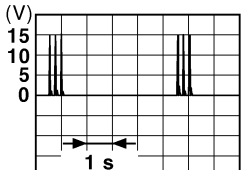
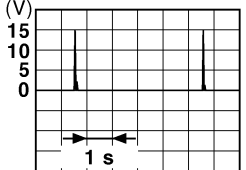
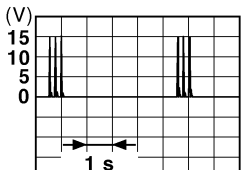
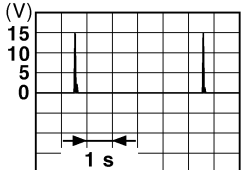
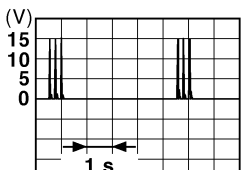
Terminal No. (Wire color)		Description		Condition	Value (Approx.)
(+)	(-)	Signal name	Input/ Output		
115 (W)	Ground	Trunk room antenna 1 (+)	Output		
				When Intelligent Key is not in the passenger compart- ment	 <p style="text-align: right; font-size: small;">JMKIA0063GB</p>
118 (L/O)	Ground	Rear bumper anten- na (-)	Output	When the trunk lid request switch is operated with ignition switch OFF	 <p style="text-align: right; font-size: small;">JMKIA0062GB</p>
				When Intelligent Key is not in the antenna detection area	 <p style="text-align: right; font-size: small;">JMKIA0063GB</p>
119 (BR/ W)	Ground	Rear bumper anten- na (+)	Output	When the trunk lid request switch is operated with ignition switch OFF	 <p style="text-align: right; font-size: small;">JMKIA0062GB</p>
				When Intelligent Key is not in the antenna detection area	 <p style="text-align: right; font-size: small;">JMKIA0063GB</p>

# BCM (BODY CONTROL MODULE)

[WITH DUAL PANEL SUNROOF]

< ECU DIAGNOSIS >

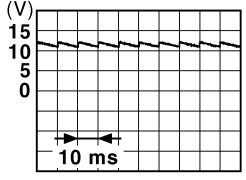
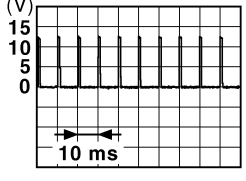
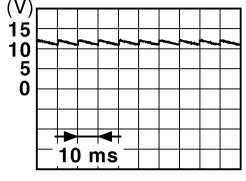
Terminal No. (Wire color)		Description		Condition	Value (Approx.)	
		Signal name	Input/ Output			
(+)	(-)					
127 (BR/ W)	Ground	Ignition relay (IPDM E/R) control	Output	Ignition switch	OFF or ACC	Battery voltage
					ON	0V
130 (W)	Ground	Trunk room lamp switch	Input	Trunk room lamp switch	OFF (trunk is closed)	 <p style="text-align: right; margin-right: 50px;">11.8V</p> <p style="text-align: right; font-size: small;">JPMIA0011GB</p>
					ON (trunk is open)	0V
132 (R)	Ground	Starter motor relay control	Output	Ignition switch ON	When selector lever is in P or N position and the brake is depressed	Battery voltage
					When selector lever is in P or N position and the brake is not depressed	0V
140 <sup>4</sup> (L/R)	Ground	Engine switch (push switch)	Input	Engine switch (push switch)	Pressed	0V
					Not pressed	Battery voltage
141 (BR)	Ground	Trunk request switch	Input	Trunk request switch	ON (pressed)	0V
					OFF (not pressed)	 <p style="text-align: right; margin-right: 50px;">1.0V</p> <p style="text-align: right; font-size: small;">JPMIA0016GB</p>
144 (GR)	Ground	Request switch buzz- er	Output	Request switch buzzer	Sounding	0V
					Not sounding	Battery voltage
147 (L/R)	Ground	Trunk lid opener switch	Input	Trunk lid opener switch	Pressed	0V
					Not pressed	Battery voltage
148 (R/W)	Ground	Rear door RH switch	Input	Rear door RH switch	OFF (when rear door RH closes)	 <p style="text-align: right; margin-right: 50px;">11.8V</p> <p style="text-align: right; font-size: small;">JPMIA0011GB</p>
					ON (when rear door RH opens)	0V

A  
B  
C  
D  
E  
F  
G  
H  
I  
J  
RF  
L  
M  
N  
O  
P

# BCM (BODY CONTROL MODULE)

< ECU DIAGNOSIS >

[WITH DUAL PANEL SUNROOF]

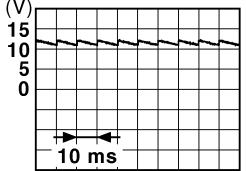
Terminal No. (Wire color)		Description		Condition		Value (Approx.)
(+)	(-)	Signal name	Input/ Output			
149 (R/B)	Ground	Rear door LH switch	Input	Rear door LH switch	OFF (when rear door LH closes)	 <p style="text-align: right; font-size: small;">JPMIA0011GB</p>
				ON (when rear door LH opens)	0V	

- 1 : With low tire pressure monitoring system
- 2 : With electronic steering column lock
- 3 : Early production
- 4 : Without electronic steering column lock



# BCM (BODY CONTROL MODULE)

[WITH DUAL PANEL SUNROOF]

< ECU DIAGNOSIS >

## Wiring Diagram

INFOID:000000005511872

BCM (BODY CONTROL MODULE)

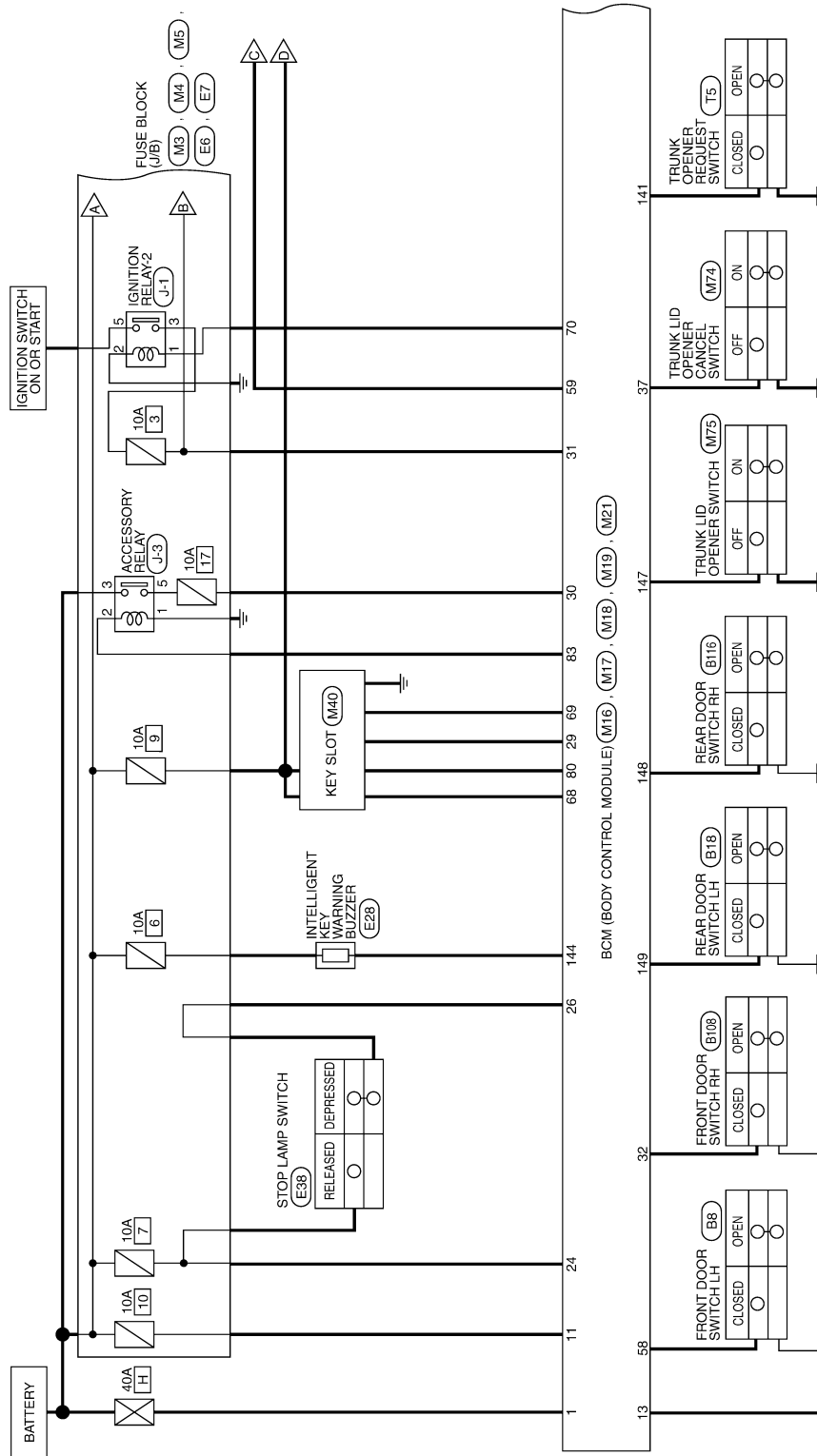

ABMWA0498GI

A  
B  
C  
D  
E  
F  
G  
H  
I  
J  
RF  
L  
M  
N  
O  
P

# BCM (BODY CONTROL MODULE)

[WITH DUAL PANEL SUNROOF]

< ECU DIAGNOSIS >

- ◊TP◊ : WITH LOW TIRE PRESSURE MONITORING SYSTEM
- ◊EH◊ : WITH ELECTRONIC STEERING COLUMN LOCK
- ◊EJ◊ : WITHOUT ELECTRONIC STEERING COLUMN LOCK

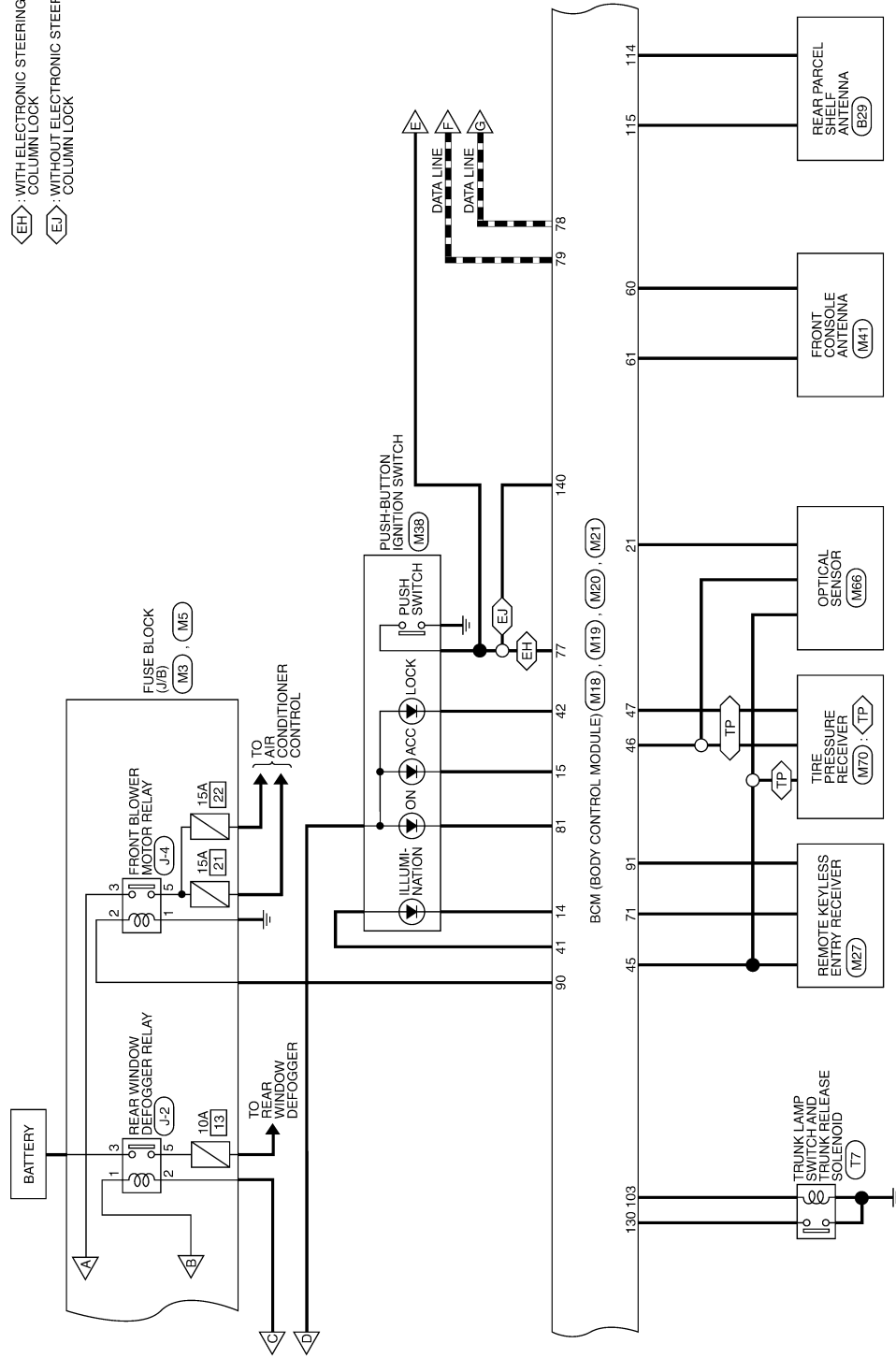

ABMWA0817GI

# BCM (BODY CONTROL MODULE)

< ECU DIAGNOSIS >

[WITH DUAL PANEL SUNROOF]

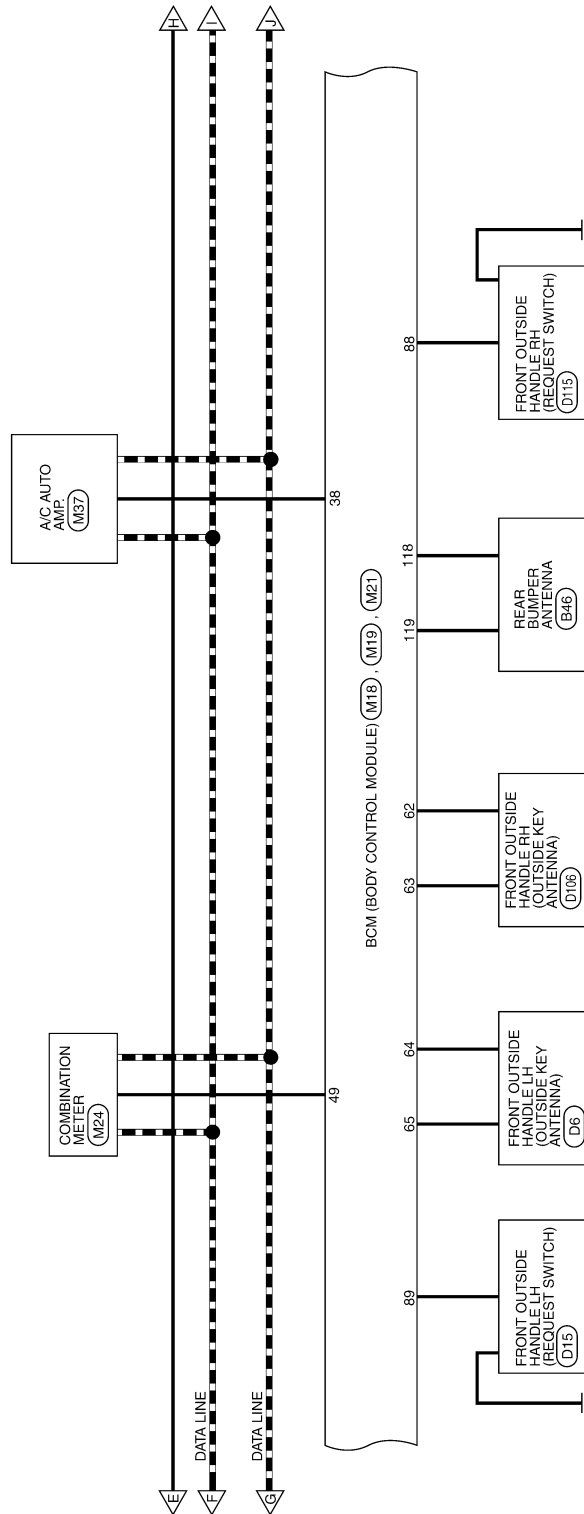

ABMWA0818GI

A  
B  
C  
D  
E  
F  
G  
H  
I  
J  
RF  
L  
M  
N  
O  
P

# BCM (BODY CONTROL MODULE)

< ECU DIAGNOSIS >

[WITH DUAL PANEL SUNROOF]

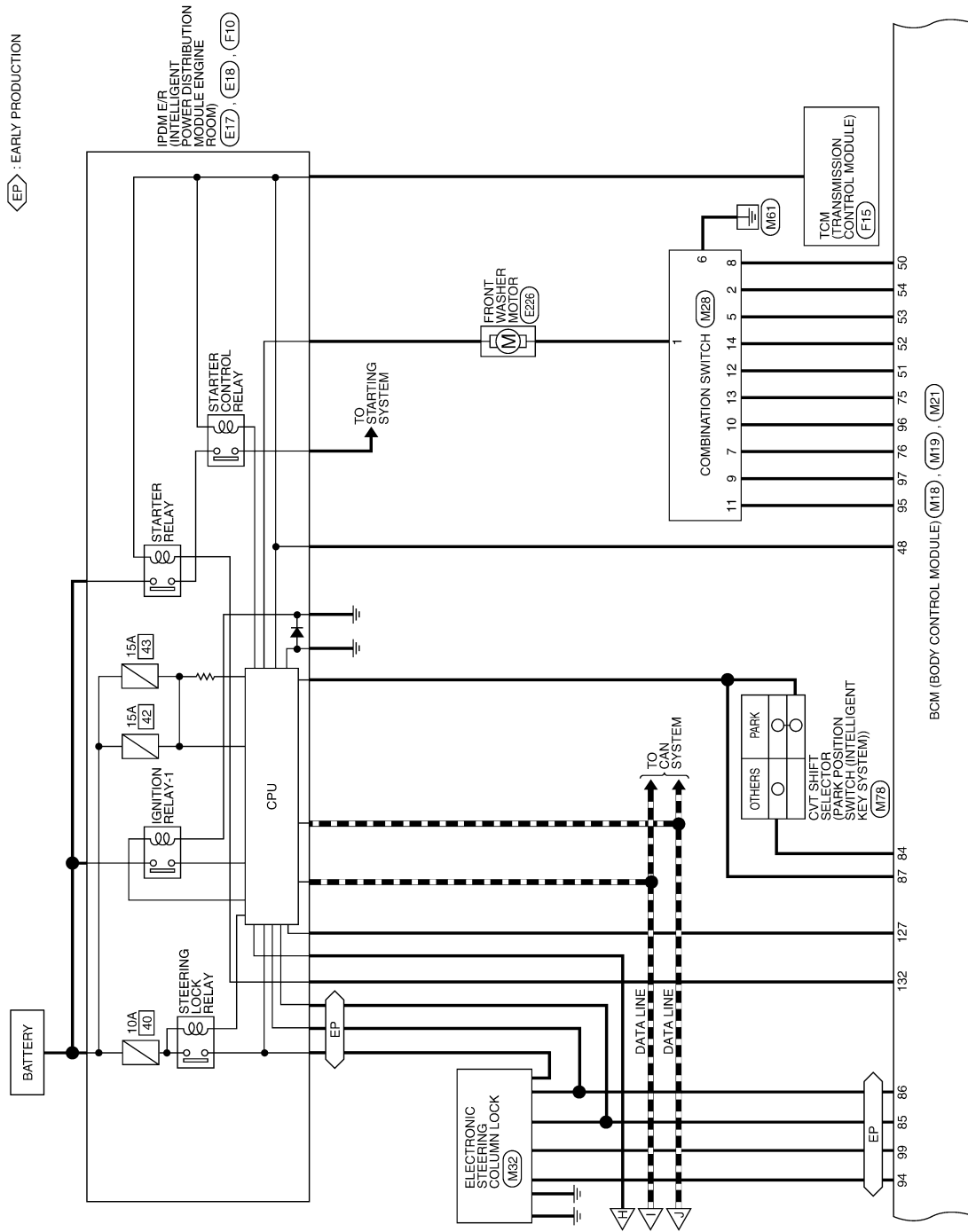

ABMWA0819GI

# BCM (BODY CONTROL MODULE)

[WITH DUAL PANEL SUNROOF]

< ECU DIAGNOSIS >

- $\langle A2 \rangle$  : WITH LEFT AND RIGHT FRONT POWER WINDOW ANTI-PINCH SYSTEM
- $\langle A3 \rangle$  : WITH FRONT AND REAR POWER WINDOW ANTI-PINCH SYSTEM
- $\langle DP \rangle$  : WITH DUAL PANEL SUNROOF
- $\langle DW \rangle$  : WITHOUT DUAL PANEL SUNROOF

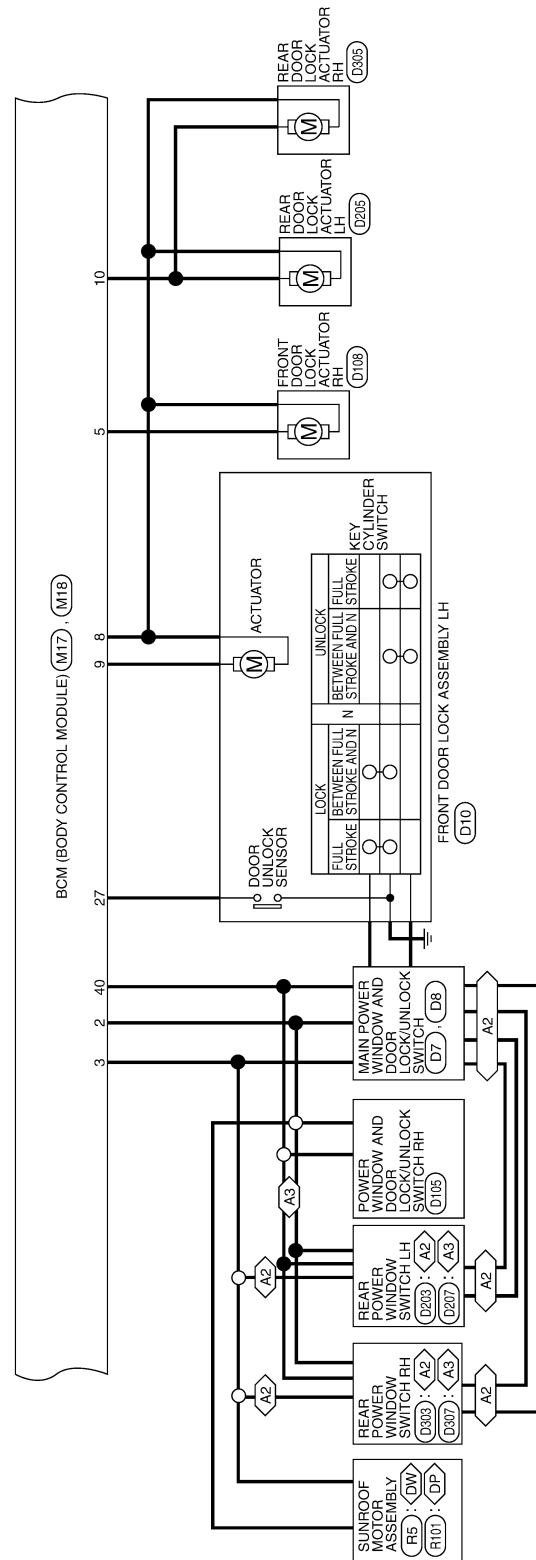

ABMWA0081GI

A  
B  
C  
D  
E  
F  
G  
H  
I  
J  
K  
L  
M  
N  
O  
P

RF

# BCM (BODY CONTROL MODULE)

< ECU DIAGNOSIS >

[WITH DUAL PANEL SUNROOF]

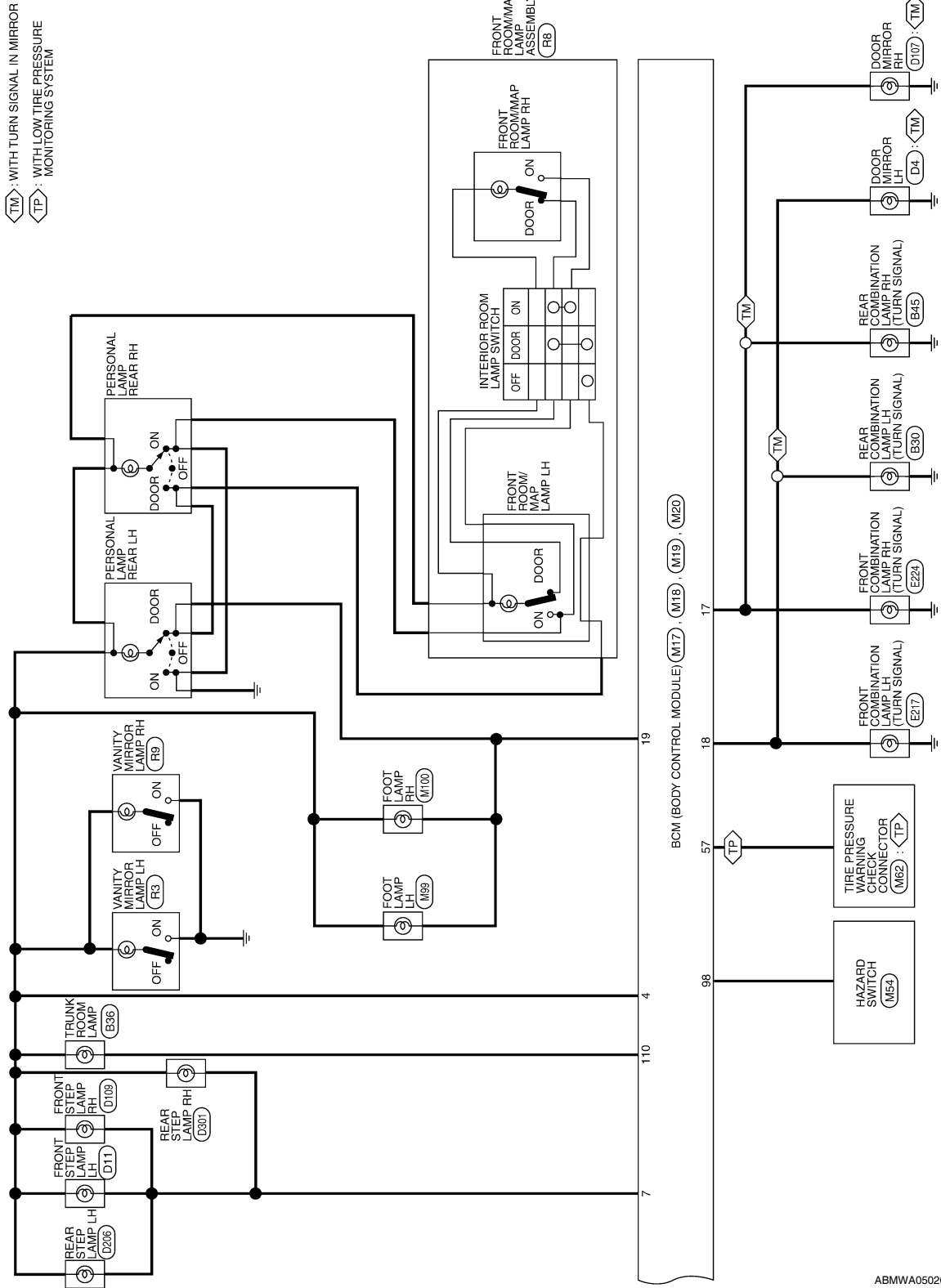

ABMWA0502GI

# BCM (BODY CONTROL MODULE)

[WITH DUAL PANEL SUNROOF]

< ECU DIAGNOSIS >

## BCM (BODY CONTROL MODULE) CONNECTORS

Connector No.	M16
Connector Name	BCM (BODY CONTROL MODULE)
Connector Color	BLACK



Terminal No.	Color of Wire	Signal Name
1	W/B	BATT (F/L)
2	R/Y	P/W POWER SUPPLY PERM
3	L/W	P/W POWER SUPPLY IGN

Connector No.	M17
Connector Name	BCM (BODY CONTROL MODULE)
Connector Color	WHITE

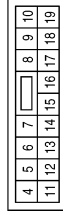

Terminal No.	Color of Wire	Signal Name
4	P/W	R/L POWER SUPPLY
5	G	DOOR UNLOCK OUTPUT AS
6	-	-
7	R/W	STEP LAMP CONT
8	V	DOOR LOCK OUTPUT ALL
9	L	DOOR UNLOCK OUTPUT (DR/FL)

Terminal No.	Color of Wire	Signal Name
10	G	DOOR UNLOCK OUTPUT (RR/RL)
11	Y/R	BAT BCM FUSE
12	-	-
13	B	GND1
14	GR/W	LOW SIDE PUSH LED
15	Y/L	ACC LED
16	-	-
17	G/B	FR FLASHER
18	G/Y	FL FLASHER
19	Y	ROOM LAMP CONT

Connector No.	M18
Connector Name	BCM (BODY CONTROL MODULE)
Connector Color	GREEN



Terminal No.	Color of Wire	Signal Name
20	-	-
21	P/B	A/L SIGNAL TYPE 1
22	-	-
23	-	-
24	R/W	BRAKE SW1
25	-	-
26	O/L	BRAKE SW2

Terminal No.	Color of Wire	Signal Name
27	O	DOOR LOCK STATUS DR
28	-	-
29	Y	FOB IN SW 1
30	V/Y	ACC F/B
31	G	IGN F/B
32	R/B	AS DOOR SW 1
33	-	-
34	-	-
35	-	-
36	-	-
37	O	TRUNK CANCEL SW
38	GR/W	REAR DEFOGGER SW
39	-	-
40	Y/G	PW K-LINE
41	W	RING LED
42	R	S/L LOCK LED
43	-	-
44	-	-

Terminal No.	Color of Wire	Signal Name
45	P	GND RF2 A/L
46	V/W	A/L POWER SUPPLY 5V
47	G/O	RF2 TUNER SIGNAL
48	R/G	SHIFT N/P/NEUTRAL SW
49	L/O	IMMO LED (SECURITY INDICATOR)
50	LG/B	OUTPUT 5
51	L/W	OUTPUT 1
52	G/B	OUTPUT 2
53	LG/R	OUTPUT 3
54	G/Y	OUTPUT 4
55	-	-
56	-	-
57	W	TPMS MODE
58	SB	DR DOOR SW
59	G/R	REAR DEFOGGER

A B C D E F G H I J K L M N O P

RF

# BCM (BODY CONTROL MODULE)

[WITH DUAL PANEL SUNROOF]

< ECU DIAGNOSIS >

Connector No.	M19
Connector Name	BCM (BODY CONTROL MODULE)
Connector Color	BLACK



79	78	77	76	75	74	73	72	71	70	69	68	67	66	65	64	63	62	61	60
59	58	57	56	55	54	53	52	51	50	49	48	47	46	45	44	43	42	41	40

Terminal No.	Color of Wire	Signal Name
60	B/R	ROOM ANT 2 B
61	W/R	ROOM ANT 2 A
62	V	AS DOOR ANT B
63	P	AS DOOR ANT A
64	V	DR DOOR ANT B
65	P	DR DOOR ANT A
66	-	-

Terminal No.	Color of Wire	Signal Name
67	-	-
68	G/O	FOB READER CLOCK
69	O	FOB READER DATA
70	R/B	IGN REL OUTPUT 2
71	L/O	RF1 TUNER SIGNAL
72	-	-
73	-	-
74	-	-
75	R/Y	INPUT 5
76	R/G	INPUT 3
77	BR	ENG START SW
78	P	CAN-L
79	L	CAN-H
80	R/L	FOB SLOT ILLUMINATION
81	LG	IGN ON LED
82	-	-
83	L	ACC CONT

Terminal No.	Color of Wire	Signal Name
84	Y/R	AT DEVICE OUT
85	L/O	S/L CONDITION 1
86	G/R	S/L CONDITION 2
87	G/B	SHIFT P/ASCD CANCEL SW
88	R	AS REQUEST SW
89	R	DR REQUEST SW
90	Y	BLOWER FAN RELAY
91	L/R	RF POWER SUPPLY 12V
92	-	-
93	-	-
94	G/Y	S/L POWER SUPPLY 12V
95	R/W	INPUT 1
96	P/B	INPUT 4
97	R/B	INPUT 2
98	G/O	HAZARD SW
99	L/Y	S/L K-LINE

Connector No.	M20
Connector Name	BCM (BODY CONTROL MODULE)
Connector Color	WHITE



100	101	102	103	104		
105	106	107	108	109	110	111

Terminal No.	Color of Wire	Signal Name
100	-	-
101	-	-
102	-	-
103	V	CDL BACK TRUNK

Terminal No.	Color of Wire	Signal Name
104	-	-
105	-	-
106	-	-
107	-	-
108	-	-
109	-	-
110	V/W	TRUNK LAMP CONT
111	-	-

ABMIA1332GB



# BCM (BODY CONTROL MODULE)

[WITH DUAL PANEL SUNROOF]

< ECU DIAGNOSIS >

Terminal No.	Color of Wire	Signal Name
136	-	-
137	-	-
138	-	-
139	-	-
140	BR	ENG START SW W/O ESCL
141	BR	TRUNK REQUEST SW
142	-	-
143	-	-
144	GR	BUZZER
145	-	-
146	-	-
147	L/R	BACK TRUNK OPENER
148	R/W	RR DOOR SW
149	R/B	RL DOOR SW
150	-	-
151	-	-

Terminal No.	Color of Wire	Signal Name
119	BR/W	BACK DOOR ANT A
120	-	-
121	-	-
122	-	-
123	-	-
124	-	-
125	-	-
126	-	-
127	BR/W	IGN RELAY OUTPUT
128	-	-
129	-	-
130	W	TRUNK SW
131	-	-
132	R	ST RELAY OUTPUT
133	-	-
134	-	-
135	-	-

Terminal No.	Color of Wire	Signal Name
10	P/B	INPUT 4
11	R/W	INPUT 1
12	L/W	OUTPUT 1
13	R/Y	INPUT 5
14	G/B	OUTPUT 2

Connector No.	M21
Connector Name	BCM (BODY CONTROL MODULE)
Connector Color	GRAY

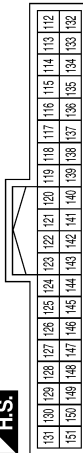

Terminal No.	Color of Wire	Signal Name
112	-	-
113	-	-
114	B	TRUNK ANT 1 B
115	W	TRUNK ANT 1 A
116	-	-
117	-	-
118	L/O	BACK DOOR ANT B

Connector No.	M28
Connector Name	COMBINATION SWITCH
Connector Color	WHITE

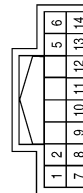

Terminal No.	Color of Wire	Signal Name
1	R/L	-
2	G/Y	OUTPUT 4
5	LG/R	OUTPUT 3
6	B	-
7	R/G	INPUT 3
8	LG/B	OUTPUT 5
9	R/B	INPUT 2

ABMIA2102GB

INFOID:000000005511873

## Fail Safe

Display contents of CONSULT	Fail-safe	Cancellation
B2013: ID DISCORD BCM-S/L*	Inhibit engine cranking	Erase DTC
B2014: CHAIN OF S/L-BCM*	Inhibit engine cranking	Erase DTC
B2190: NATS ANTENNA AMP	Inhibit engine cranking	Erase DTC

A  
B  
C  
D  
E  
F  
G  
H  
I  
J  
K  
L  
M  
N  
O  
P

RF

# BCM (BODY CONTROL MODULE)

[WITH DUAL PANEL SUNROOF]

< ECU DIAGNOSIS >

Display contents of CONSULT	Fail-safe	Cancellation
B2191: DIFFERENCE OF KEY	Inhibit engine cranking	Erase DTC
B2192: ID DISCORD BCM-ECM	Inhibit engine cranking	Erase DTC
B2193: CHAIN OF BCM-ECM	Inhibit engine cranking	Erase DTC
B2195: ANTI-SCANNING	Inhibit engine cranking	Erase DTC
B2557: VEHICLE SPEED*	Inhibit electronic steering column lock	When normal vehicle speed signals have been received from ABS actuator and electric unit (control unit) for 500 ms
B2560: STARTER CONT RELAY	Inhibit engine cranking	500 ms after the following CAN signal communication status has become consistent <ul style="list-style-type: none"> <li>• Starter control relay signal</li> <li>• Starter relay status signal</li> </ul>
B2562: LO VOLTAGE	<ul style="list-style-type: none"> <li>• Inhibit engine cranking</li> <li>• Inhibit electronic steering column lock*</li> </ul>	100 ms after the power supply voltage increases to more than 8.8 V
B2601: SHIFT POSITION*	Inhibit electronic steering column lock	500 ms after the following signal reception status becomes consistent <ul style="list-style-type: none"> <li>• Selector lever P position switch signal</li> <li>• P range signal (CAN)</li> </ul>
B2602: SHIFT POSITION*	Inhibit electronic steering column lock	5 seconds after the following BCM recognition conditions are fulfilled <ul style="list-style-type: none"> <li>• Ignition switch is in the ON position</li> <li>• Selector lever P position switch signal: Except P position (battery voltage)</li> <li>• Vehicle speed: 4 km/h or more</li> </ul>
B2603: SHIFT POSI STATUS*	Inhibit electronic steering column lock	500 ms after the following BCM recognition conditions are fulfilled <ul style="list-style-type: none"> <li>• Ignition switch is in the ON position</li> <li>• Selector lever P position switch signal: Except P position (battery voltage)</li> <li>• Selector lever transmission range switch signal: Except P and N positions (0 V)</li> </ul>
B2604: TRANSMISSION RANGE SWITCH*	Inhibit electronic steering column lock	500 ms after any of the following BCM recognition conditions is fulfilled <ul style="list-style-type: none"> <li>• Status 1                             <ul style="list-style-type: none"> <li>- Ignition switch is in the ON position</li> <li>- Selector lever transmission range switch signal: P and N position (battery voltage)</li> <li>- P range signal or N range signal (CAN): ON</li> </ul> </li> <li>• Status 2                             <ul style="list-style-type: none"> <li>- Ignition switch is in the ON position</li> <li>- Selector lever transmission range switch signal: Except P and N positions (0 V)</li> <li>- P range signal and N range signal (CAN): OFF</li> </ul> </li> </ul>
B2605: TRANSMISSION RANGE SWITCH*	Inhibit electronic steering column lock	500 ms after any of the following BCM recognition conditions is fulfilled <ul style="list-style-type: none"> <li>• Ignition switch is in the ON position</li> <li>- Power position: IGN</li> <li>- Selector lever transmission range switch signal: Except P and N positions (0 V)</li> <li>- Transmission range switch signal (CAN): OFF</li> <li>• Status 2                             <ul style="list-style-type: none"> <li>- Ignition switch is in the ON position</li> <li>- Selector lever transmission range switch signal: P or N position (battery voltage)</li> <li>- Transmission range switch signal (CAN): ON</li> </ul> </li> </ul>
B2606: S/L RELAY*	Inhibit engine cranking	500 ms after the following CAN signal communication status has become consistent <ul style="list-style-type: none"> <li>• Electronic steering column lock relay signal (Request signal)</li> <li>• Electronic steering column lock relay signal (Condition signal)</li> </ul>

# BCM (BODY CONTROL MODULE)

< ECU DIAGNOSIS >

[WITH DUAL PANEL SUNROOF]

Display contents of CONSULT	Fail-safe	Cancellation
B2607: S/L RELAY*	Inhibit engine cranking	500 ms after the following CAN signal communication status has become consistent <ul style="list-style-type: none"> <li>Electronic steering column lock relay signal (Request signal)</li> <li>Electronic steering column lock relay signal (Condition signal)</li> </ul>
B2608: STARTER RELAY	Inhibit engine cranking	500 ms after the following signal communication status becomes consistent <ul style="list-style-type: none"> <li>Starter motor relay control signal</li> <li>Starter relay status signal (CAN)</li> </ul>
B2609: S/L STATUS*	<ul style="list-style-type: none"> <li>Inhibit engine cranking</li> <li>Inhibit electronic steering column lock</li> </ul>	When the following electronic steering column lock conditions agree <ul style="list-style-type: none"> <li>BCM electronic steering column lock control status</li> <li>Electronic steering column lock condition No. 1 signal status</li> <li>Electronic steering column lock condition No. 2 signal status</li> </ul>
B260A: IGNITION RELAY	Inhibit engine cranking	500 ms after the following conditions are fulfilled <ul style="list-style-type: none"> <li>IGN relay (IPDM E/R) control signal: OFF (Battery voltage)</li> <li>Ignition ON signal (CAN to IPDM E/R): OFF (Request signal)</li> <li>Ignition ON signal (CAN from IPDM E/R): OFF (Condition signal)</li> </ul>
B260F: ENG STATE SIG LOST	Maintains the power supply position attained at the time of DTC detection	When any of the following conditions is fulfilled <ul style="list-style-type: none"> <li>Power position changes to ACC</li> <li>Receives engine status signal (CAN)</li> </ul>
B2612: S/L STATUS*	<ul style="list-style-type: none"> <li>Inhibit engine cranking</li> <li>Inhibit electronic steering column lock</li> </ul>	When any of the following conditions is fulfilled <ul style="list-style-type: none"> <li>Electronic steering column lock unit status signal (CAN) is received normally</li> <li>The BCM electronic steering column lock control status matches the electronic steering column lock status recognized by the electronic steering column lock unit status signal (CAN from IPDM E/R)</li> </ul>
B2617: STARTER RELAY CIRC	Inhibit engine cranking	1 second after the starter motor relay control inside BCM becomes normal
B2618: BCM	Inhibit engine cranking	1 second after the ignition relay (IPDM E/R) control inside BCM becomes normal
B2619: BCM*	Inhibit engine cranking	1 second after the electronic steering column lock unit power supply output control inside BCM becomes normal
B26E1: ENG STATE NO RECIV	Inhibit engine cranking	When any of the following conditions are fulfilled <ul style="list-style-type: none"> <li>Power position changes to ACC</li> <li>Receives engine status signal (CAN)</li> </ul>

\* : With electronic steering column lock

## DTC Inspection Priority Chart

INFOID:000000005511874

If some DTCs are displayed at the same time, perform inspections one by one based on the following priority chart.

Priority	DTC
1	<ul style="list-style-type: none"> <li>B2562: LO VOLTAGE</li> </ul>
2	<ul style="list-style-type: none"> <li>U1000: CAN COMM CIRCUIT</li> <li>U1010: CONTROL UNIT (CAN)</li> </ul>
3	<ul style="list-style-type: none"> <li>B2190: NATS ANTENNA AMP</li> <li>B2191: DIFFERENCE OF KEY</li> <li>B2192: ID DISCORD BCM-ECM</li> <li>B2193: CHAIN OF BCM-ECM</li> </ul>

# BCM (BODY CONTROL MODULE)

< ECU DIAGNOSIS >

[WITH DUAL PANEL SUNROOF]

Priority	DTC
4	<ul style="list-style-type: none"> <li>• B2013: ID DISCORD BCM-S/L*</li> <li>• B2014: CHAIN OF S/L-BCM*</li> <li>• B2553: IGNITION RELAY</li> <li>• B2555: STOP LAMP</li> <li>• B2556: PUSH-BTN IGN SW</li> <li>• B2557: VEHICLE SPEED</li> <li>• B2560: STARTER CONT RELAY</li> <li>• B2601: SHIFT POSITION</li> <li>• B2602: SHIFT POSITION</li> <li>• B2603: SHIFT POSI STATUS</li> <li>• B2604: TRANSMISSION RANGE SWITCH</li> <li>• B2605: TRANSMISSION RANGE SWITCH</li> <li>• B2606: S/L RELAY*</li> <li>• B2607: S/L RELAY*</li> <li>• B2608: STARTER RELAY</li> <li>• B2609: S/L STATUS*</li> <li>• B260A: IGNITION RELAY</li> <li>• B260B: STEERING LOCK UNIT*</li> <li>• B260C: STEERING LOCK UNIT*</li> <li>• B260D: STEERING LOCK UNIT*</li> <li>• B260F: ENG STATE SIG LOST</li> <li>• B2612: S/L STATUS*</li> <li>• B2614: ACC RELAY CIRC</li> <li>• B2615: BLOWER RELAY CIRC</li> <li>• B2616: IGN RELAY CIRC</li> <li>• B2617: STARTER RELAY CIRC</li> <li>• B2618: BCM</li> <li>• B2619: BCM*</li> <li>• B261A: PUSH-BTN IGN SW</li> <li>• B26E1: ENG STATE NO RECIV</li> <li>• C1729: VHCL SPEED SIG ERR</li> <li>• U0415: VEHICLE SPEED SIG</li> </ul>
5	<ul style="list-style-type: none"> <li>• C1704: LOW PRESSURE FL</li> <li>• C1705: LOW PRESSURE FR</li> <li>• C1706: LOW PRESSURE RR</li> <li>• C1707: LOW PRESSURE RL</li> <li>• C1708: [NO DATA] FL</li> <li>• C1709: [NO DATA] FR</li> <li>• C1710: [NO DATA] RR</li> <li>• C1711: [NO DATA] RL</li> <li>• C1712: [CHECKSUM ERR] FL</li> <li>• C1713: [CHECKSUM ERR] FR</li> <li>• C1714: [CHECKSUM ERR] RR</li> <li>• C1715: [CHECKSUM ERR] RL</li> <li>• C1716: [PRESSDATA ERR] FL</li> <li>• C1717: [PRESSDATA ERR] FR</li> <li>• C1718: [PRESSDATA ERR] RR</li> <li>• C1719: [PRESSDATA ERR] RL</li> <li>• C1720: [CODE ERR] FL</li> <li>• C1721: [CODE ERR] FR</li> <li>• C1722: [CODE ERR] RR</li> <li>• C1723: [CODE ERR] RL</li> <li>• C1724: [BATT VOLT LOW] FL</li> <li>• C1725: [BATT VOLT LOW] FR</li> <li>• C1726: [BATT VOLT LOW] RR</li> <li>• C1727: [BATT VOLT LOW] RL</li> <li>• C1734: CONTROL UNIT</li> </ul>
6	<ul style="list-style-type: none"> <li>• B2622: INSIDE ANTENNA</li> <li>• B2623: INSIDE ANTENNA</li> </ul>

\* : With electronic steering column lock

# BCM (BODY CONTROL MODULE)

[WITH DUAL PANEL SUNROOF]

< ECU DIAGNOSIS >

## DTC Index

INFOID:000000005511875

### NOTE:

- Details of time display
- CRNT: Displays when there is a malfunction now or after returning to the normal condition until turning ignition switch OFF → ON again.
- 1 - 39: Displayed if any previous malfunction is present when current condition is normal. It increases 1 → 2 → 3...38 → 39 after returning to the normal condition whenever ignition switch OFF → ON. The counter remains at 39 even if the number of cycles exceeds it. It is counted from 1 again when turning ignition switch OFF → ON after returning to the normal condition if the malfunction is detected again.

CONSULT display	Fail-safe	Intelligent Key warning lamp ON	Tire pressure monitor warning lamp ON	Reference page
No DTC is detected. further testing may be required.	—	—	—	—
U1000: CAN COMM CIRCUIT	—	—	—	<a href="#">BCS-36</a>
U1010: CONTROL UNIT (CAN)	—	—	—	<a href="#">BCS-37</a>
U0415: VEHICLE SPEED SIG	—	—	—	<a href="#">BCS-38</a>
B2013: ID DISCORD BCM-S/L*	×	—	—	<a href="#">SEC-39</a>
B2014: CHAIN OF S/L-BCM*	×	—	—	<a href="#">SEC-40</a>
B2190: NATS ANTENNA AMP	×	—	—	<a href="#">SEC-43</a>
B2191: DIFFERENCE OF KEY	×	—	—	<a href="#">SEC-46</a>
B2192: ID DISCORD BCM-ECM	×	—	—	<a href="#">SEC-47</a>
B2193: CHAIN OF BCM-ECM	×	—	—	<a href="#">SEC-48</a>
B2553: IGNITION RELAY	—	—	—	<a href="#">PCS-55</a>
B2555: STOP LAMP	—	—	—	<a href="#">SEC-49</a>
B2556: PUSH-BTN IGN SW	—	×	—	<a href="#">SEC-52</a>
B2557: VEHICLE SPEED	×	×	—	<a href="#">SEC-54</a>
B2560: STARTER CONT RELAY	×	×	—	<a href="#">SEC-55</a>
B2562: LOW VOLTAGE	—	—	—	<a href="#">BCS-39</a>
B2601: SHIFT POSITION	×	×	—	<a href="#">SEC-56</a>
B2602: SHIFT POSITION	×	×	—	<a href="#">SEC-59</a>
B2603: SHIFT POSI STATUS	×	×	—	<a href="#">SEC-62</a>
B2604: TRANSMISSION RANGE SWITCH	×	×	—	<a href="#">SEC-65</a>
B2605: TRANSMISSION RANGE SWITCH	×	×	—	<a href="#">SEC-67</a>
B2606: S/L RELAY*	×	×	—	<a href="#">SEC-69</a>
B2607: S/L RELAY*	×	×	—	<a href="#">SEC-70</a>
B2608: STARTER RELAY	×	×	—	<a href="#">SEC-72</a>
B2609: S/L STATUS*	×	×	—	<a href="#">SEC-74</a>
B260A: IGNITION RELAY	×	×	—	<a href="#">PCS-57</a>
B260B: STEERING LOCK UNIT*	—	×	—	<a href="#">SEC-78</a>
B260C: STEERING LOCK UNIT*	—	×	—	<a href="#">SEC-79</a>
B260D: STEERING LOCK UNIT*	—	×	—	<a href="#">SEC-80</a>
B260F: ENG STATE SIG LOST	×	×	—	<a href="#">SEC-81</a>
B2612: S/L STATUS*	×	×	—	<a href="#">SEC-83</a>
B2614: ACC RELAY CIRC	—	×	—	<a href="#">PCS-59</a>

# BCM (BODY CONTROL MODULE)

< ECU DIAGNOSIS >

[WITH DUAL PANEL SUNROOF]

CONSULT display	Fail-safe	Intelligent Key warning lamp ON	Tire pressure monitor warning lamp ON	Reference page
B2615: BLOWER RELAY CIRC	—	×	—	<a href="#">PCS-62</a>
B2616: IGN RELAY CIRC	—	×	—	<a href="#">PCS-65</a>
B2617: STARTER RELAY CIRC	×	×	—	<a href="#">PCS-65</a>
B2618: BCM	×	×	—	<a href="#">PCS-68</a>
B2619: BCM*	×	×	—	<a href="#">SEC-89</a>
B261A: PUSH-BTN IGN SW	—	×	—	<a href="#">SEC-90</a>
B2622: INSIDE ANTENNA	—	—	—	<a href="#">DLK-60</a>
B2623: INSIDE ANTENNA	—	—	—	<a href="#">DLK-63</a>
B26E1: ENG STATE NO RES	×	×	—	<a href="#">SEC-82</a>
C1704: LOW PRESSURE FL	—	—	×	<a href="#">WT-48</a>
C1705: LOW PRESSURE FR	—	—	×	<a href="#">WT-48</a>
C1706: LOW PRESSURE RR	—	—	×	<a href="#">WT-48</a>
C1707: LOW PRESSURE RL	—	—	×	<a href="#">WT-48</a>
C1708: [NO DATA] FL	—	—	×	<a href="#">WT-14</a>
C1709: [NO DATA] FR	—	—	×	<a href="#">WT-14</a>
C1710: [NO DATA] RR	—	—	×	<a href="#">WT-14</a>
C1711: [NO DATA] RL	—	—	×	<a href="#">WT-14</a>
C1712: [CHECKSUM ERR] FL	—	—	×	<a href="#">WT-16</a>
C1713: [CHECKSUM ERR] FR	—	—	×	<a href="#">WT-16</a>
C1714: [CHECKSUM ERR] RR	—	—	×	<a href="#">WT-16</a>
C1715: [CHECKSUM ERR] RL	—	—	×	<a href="#">WT-16</a>
C1716: [PRESSDATA ERR] FL	—	—	×	<a href="#">WT-18</a>
C1717: [PRESSDATA ERR] FR	—	—	×	<a href="#">WT-18</a>
C1718: [PRESSDATA ERR] RR	—	—	×	<a href="#">WT-18</a>
C1719: [PRESSDATA ERR] RL	—	—	×	<a href="#">WT-18</a>
C1720: [CODE ERR] FL	—	—	×	<a href="#">WT-16</a>
C1721: [CODE ERR] FR	—	—	×	<a href="#">WT-16</a>
C1722: [CODE ERR] RR	—	—	×	<a href="#">WT-16</a>
C1723: [CODE ERR] RL	—	—	×	<a href="#">WT-16</a>
C1724: [BATT VOLT LOW] FL	—	—	×	<a href="#">WT-16</a>
C1725: [BATT VOLT LOW] FR	—	—	×	<a href="#">WT-16</a>
C1726: [BATT VOLT LOW] RR	—	—	×	<a href="#">WT-16</a>
C1727: [BATT VOLT LOW] RL	—	—	×	<a href="#">WT-16</a>
C1729: VHCL SPEED SIG ERR	—	—	×	<a href="#">WT-20</a>
C1734: CONTROL UNIT	—	—	×	<a href="#">WT-21</a>

\* : With electronic steering column lock

# SUNROOF MOTOR ASSEMBLY

[WITH DUAL PANEL SUNROOF]

< ECU DIAGNOSIS >

## SUNROOF MOTOR ASSEMBLY

Reference Value

INFOID:000000005461878

TERMINAL LAYOUT

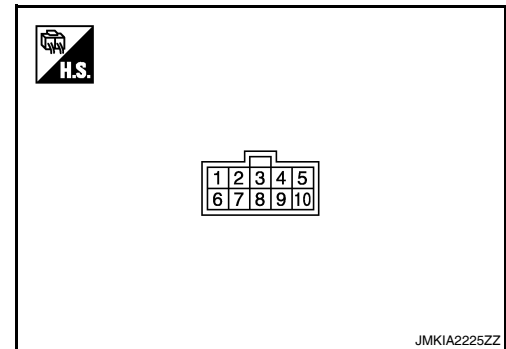

PHYSICAL VALUES

Terminal No. (Wire color)		Description		Condition	Voltage (V) (Approx.)
+	-	Signal name	Input/ Output		
1 (B)	Ground	Ground	—	—	0
2 (O)	Ground	Ground	—	—	0
3 (R)	Ground	RAP signal	Input	Ignition switch ON	Battery voltage
				Within 45 second after ignition switch is turned to OFF.	Battery voltage
				When driver side or passenger side door is opened during retained power operation or retained power operation is finished.	0
4 (Y)	Ground	Sunroof switch signal (PUSH)	Input	Sunroof switch	PUSH 0 Other than above Battery voltage
				Sunroof switch	OPEN (1st and 2nd) 0 Other than above Battery voltage
5 (LG)	Ground	Sunroof switch signal (OPEN)	Input	Sunroof switch	OPEN (1st and 2nd) 0 Other than above Battery voltage
				Sunroof switch	Other than above Battery voltage
6 (L)	Ground	Battery voltage	—	—	Battery voltage
7 (P)	Ground	Communication line	Input/ Output	Ignition switch ON	

JMKIA1869ZZ

# SUNROOF MOTOR ASSEMBLY

< ECU DIAGNOSIS >

[WITH DUAL PANEL SUNROOF]

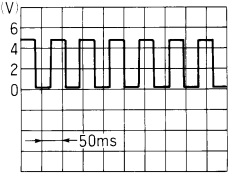
Terminal No. (Wire color)		Description		Condition	Voltage (V) (Approx.)
+	-	Signal name	Input/ Output		
8 (BR)	Ground	Vehicle speed signal (2-pulse)	Input	Speed meter operated [When vehicle speed is approx. 40km/h (25MPH)]	
9 (W)	Ground	Sunroof switch signal (2nd)	Input	Sunroof switch	OPEN or CLOSE (2nd)  0
				Other than above	Battery voltage
10 (V)	Ground	Sunroof switch signal (CLOSE)	Input	Sunroof switch	CLOSE (1st and 2nd)  0
				Other than above	Battery voltage



# SUNROOF MOTOR ASSEMBLY

[WITH DUAL PANEL SUNROOF]

< ECU DIAGNOSIS >

## Wiring Diagram

INFOID:000000005461879

### DUAL PANEL SUNROOF

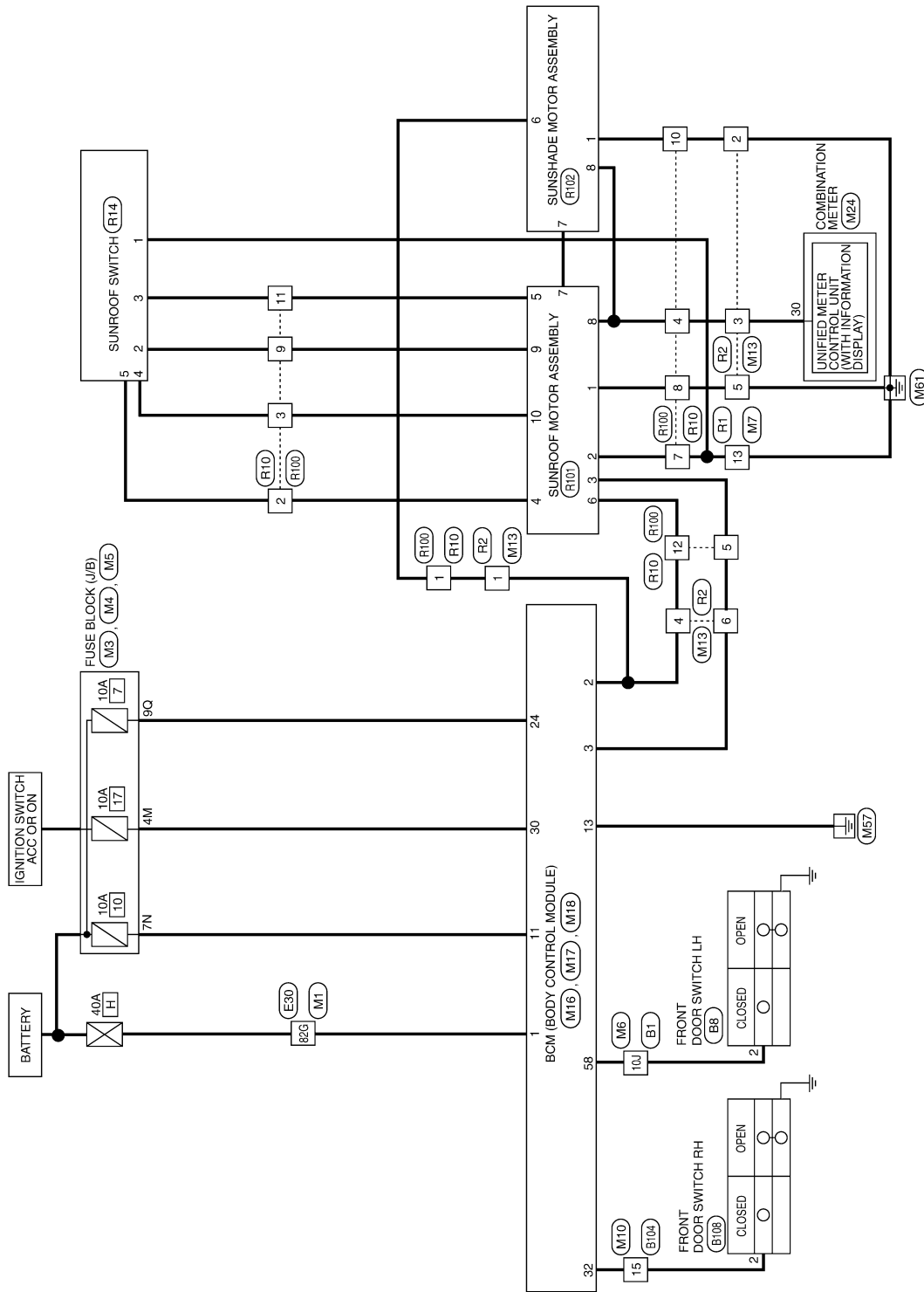

ABKWA0607GE

A  
B  
C  
D  
E  
F  
G  
H  
I  
J  
RF  
L  
M  
N  
O  
P

# SUNROOF MOTOR ASSEMBLY

[WITH DUAL PANEL SUNROOF]

< ECU DIAGNOSIS >

## DUAL PANEL SUNROOF CONNECTORS

Connector No.	M1
Connector Name	WIRE TO WIRE
Connector Color	WHITE

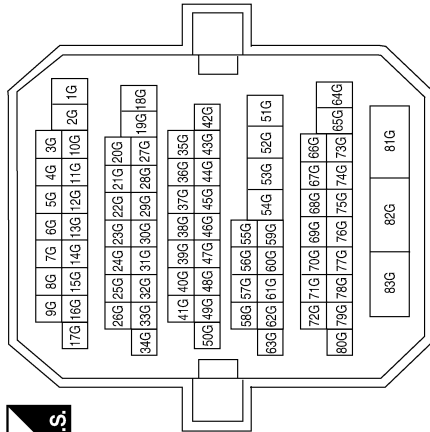

Terminal No.	Color of Wire	Signal Name
82G	W/B	-

Connector No.	M3
Connector Name	FUSE BLOCK (J/B)
Connector Color	WHITE

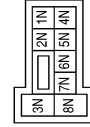

Terminal No.	Color of Wire	Signal Name
7N	Y/R	-

Connector No.	M5
Connector Name	FUSE BLOCK (J/B)
Connector Color	WHITE



Connector No.	M4
Connector Name	FUSE BLOCK (J/B)
Connector Color	WHITE

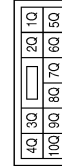

Terminal No.	Color of Wire	Signal Name
4M	V/Y	-

Terminal No.	Color of Wire	Signal Name
9Q	R/W	-

# SUNROOF MOTOR ASSEMBLY

[WITH DUAL PANEL SUNROOF]

< ECU DIAGNOSIS >

Connector No.	M7
Connector Name	WIRE TO WIRE
Connector Color	WHITE

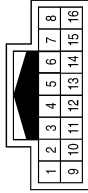

Terminal No.	13	Color of Wire	B	Signal Name	-
--------------	----	---------------	---	-------------	---

Terminal No.	10J	Color of Wire	SB	Signal Name	-
--------------	-----	---------------	----	-------------	---

Connector No.	M6
Connector Name	WIRE TO WIRE
Connector Color	WHITE

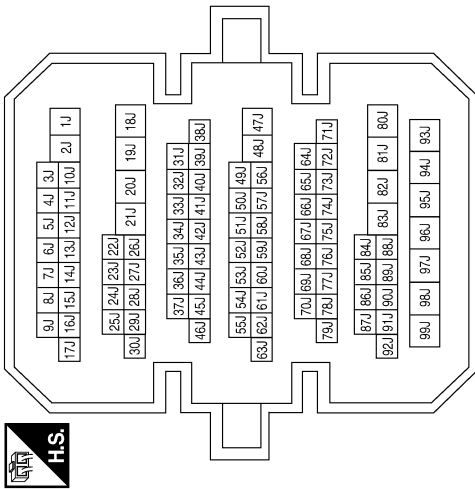

Connector No.	M16
Connector Name	BCM (BODY CONTROL MODULE)
Connector Color	BLACK



Terminal No.	1	Color of Wire	W/B	Signal Name	BATT (F/L)
2	R/Y	P/W POWER SUPPLY PERM			
3	L/W	P/W POWER SUPPLY IGN			

Connector No.	M13
Connector Name	WIRE TO WIRE
Connector Color	WHITE

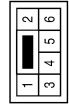

Terminal No.	1	Color of Wire	R/Y	Signal Name	-
2	B	-			
3	L/B	-			
4	R/Y	-			
5	B	-			
6	L/W	-			

Connector No.	M10
Connector Name	WIRE TO WIRE
Connector Color	WHITE

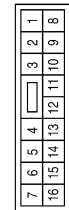

Terminal No.	15	Color of Wire	R/B	Signal Name	-
--------------	----	---------------	-----	-------------	---

ABKIA1141GB

A B C D E F G H I J L M N O P RF

# SUNROOF MOTOR ASSEMBLY

[WITH DUAL PANEL SUNROOF]

< ECU DIAGNOSIS >

Connector No.	M17
Connector Name	BCM (BODY CONTROL MODULE)
Connector Color	WHITE

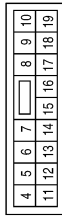

Terminal No.	Color of Wire	Signal Name
11	Y/R	BAT BCM FUSE
13	B	GND1

Connector No.	M18
Connector Name	BCM (BODY CONTROL MODULE)
Connector Color	GREEN



Terminal No.	Color of Wire	Signal Name
24	R/W	BRAKE SW 1
30	V/Y	ACC F/B
32	R/B	AS DOOR SW 1
58	SB	DR DOOR SW

Connector No.	M24
Connector Name	COMBINATION METER
Connector Color	WHITE



Terminal No.	Color of Wire	Signal Name
30	L/B	2P/R OUT

Connector No.	E30
Connector Name	WIRE TO WIRE
Connector Color	WHITE



Terminal No.	Color of Wire	Signal Name
82G	LG	-

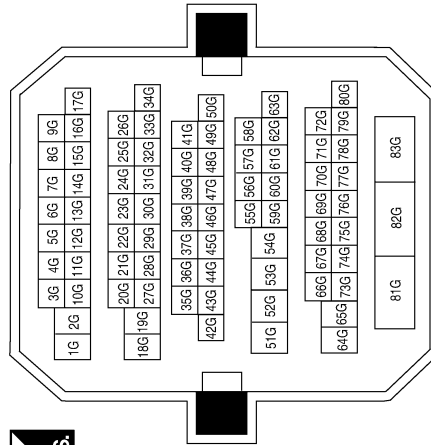

ABKIA1784GB

# SUNROOF MOTOR ASSEMBLY

[WITH DUAL PANEL SUNROOF]

< ECU DIAGNOSIS >

Connector No.	B8
Connector Name	FRONT DOOR SWITCH LH
Connector Color	WHITE

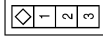

Terminal No.	Color of Wire	Signal Name
2	SB	-

Terminal No.	Color of Wire	Signal Name
10J	SB	-

Connector No.	B1
Connector Name	WIRE TO WIRE
Connector Color	WHITE

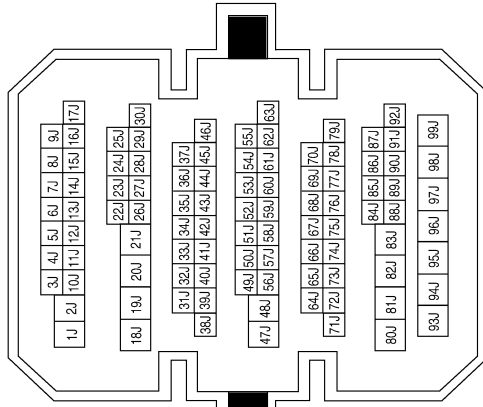

Connector No.	R1
Connector Name	WIRE TO WIRE
Connector Color	WHITE

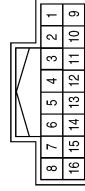

Terminal No.	Color of Wire	Signal Name
13	B	-

Connector No.	B108
Connector Name	FRONT DOOR SWITCH RH
Connector Color	WHITE



Terminal No.	Color of Wire	Signal Name
2	GR	-

Connector No.	B104
Connector Name	WIRE TO WIRE
Connector Color	WHITE

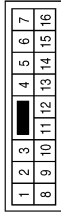

Terminal No.	Color of Wire	Signal Name
15	GR	-

A  
B  
C  
D  
E  
F  
G  
H  
I  
J  
RF  
L  
M  
N  
O  
P

# SUNROOF MOTOR ASSEMBLY

[WITH DUAL PANEL SUNROOF]

< ECU DIAGNOSIS >

Connector No.	R14
Connector Name	SUNROOF SWITCH (WITH DUAL PANEL SUNROOF)
Connector Color	WHITE

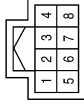

Terminal No.	Color of Wire	Signal Name
1	B	GND
2	G	AUTO 2nd
3	Y	OPEN SLIDE 1st
4	LG	CLOSE SLIDE 1st
5	W/R	PUSH

Connector No.	R10
Connector Name	WIRE TO WIRE
Connector Color	WHITE

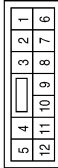

Terminal No.	Color of Wire	Signal Name
1	R	-
2	W/R	-
3	LG	-
4	L/B	-
5	L/W	-
7	B	-
8	B	-
9	G	-
10	B/L	-
11	Y	-
12	R/Y	-

Terminal No.	Color of Wire	Signal Name
8	B	-
9	W	-
10	B	-
11	LG	-
12	L	-

Connector No.	R2
Connector Name	WIRE TO WIRE
Connector Color	WHITE



Terminal No.	Color of Wire	Signal Name
1	R	-
2	B/L	-
3	L/B	-
4	R/Y	-
5	B	-
6	L/W	-

Connector No.	R100
Connector Name	WIRE TO WIRE
Connector Color	WHITE

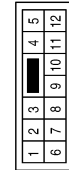

Terminal No.	Color of Wire	Signal Name
1	G	-
2	Y	-
3	V	-
4	BR	-
5	R	-
7	O	-

ABKIA0428GB

# SUNROOF MOTOR ASSEMBLY

< ECU DIAGNOSIS >

[WITH DUAL PANEL SUNROOF]

A  
B  
C  
D  
E  
F  
G  
H  
I  
J  
RF  
L  
M  
N  
O  
P

Connector No.	R102
Connector Name	SUNSHADE MOTOR ASSEMBLY
Connector Color	GRAY

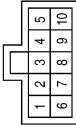

Terminal No.	Color of Wire	Signal Name
1	B	GND2
6	G	BATT 2
7	P	SERIAL
8	BR	SPEED (2P)

Connector No.	R101
Connector Name	SUNROOF MOTOR ASSEMBLY (WITH DUAL PANEL SUNROOF)
Connector Color	GRAY

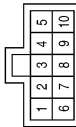

Terminal No.	Color of Wire	Signal Name
1	B	GND
2	O	-
3	R	IGN
4	Y	PUSH SW
5	LG	OPEN SW
6	L	BATT
7	P	SERIAL
8	BR	SPEED(2P)
9	W	2ND CLICK SW
10	V	CLOSE SW

ABKIA0429GB

# SUNSHADE MOTOR ASSEMBLY

[WITH DUAL PANEL SUNROOF]

< ECU DIAGNOSIS >

## SUNSHADE MOTOR ASSEMBLY

Reference Value

INFOID:000000005461880

TERMINAL LAYOUT

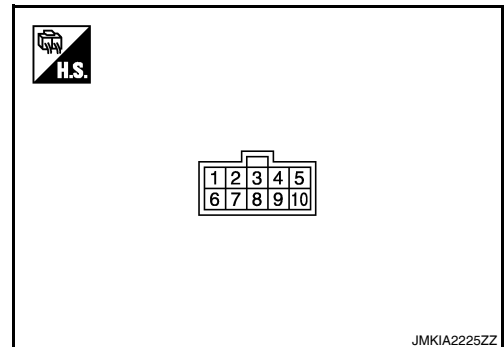

PHYSICAL VALUES

Terminal No. (Wire color)		Description		Condition	Voltage (V) (Approx.)
+	-	Signal name	Input/ Output		
1 (B)	Ground	Ground	—	—	0
6 (G)	Ground	Battery voltage	—	—	Battery voltage
7 (P)	Ground	Communication line	Input/ Output	Ignition switch ON	<p style="text-align: right; font-size: small;">JMKIA1869ZZ</p>
8 (BR)	Ground	Vehicle speed signal (2-pulse)	Input	Speed meter operated [When vehicle speed is approx. 40km/h (25MPH)]	<p style="text-align: right; font-size: small;">ELF1080D</p>



# SUNSHADE MOTOR ASSEMBLY

[WITH DUAL PANEL SUNROOF]

< ECU DIAGNOSIS >

## Wiring Diagram

INFOID:000000005530305

### DUAL PANEL SUNROOF

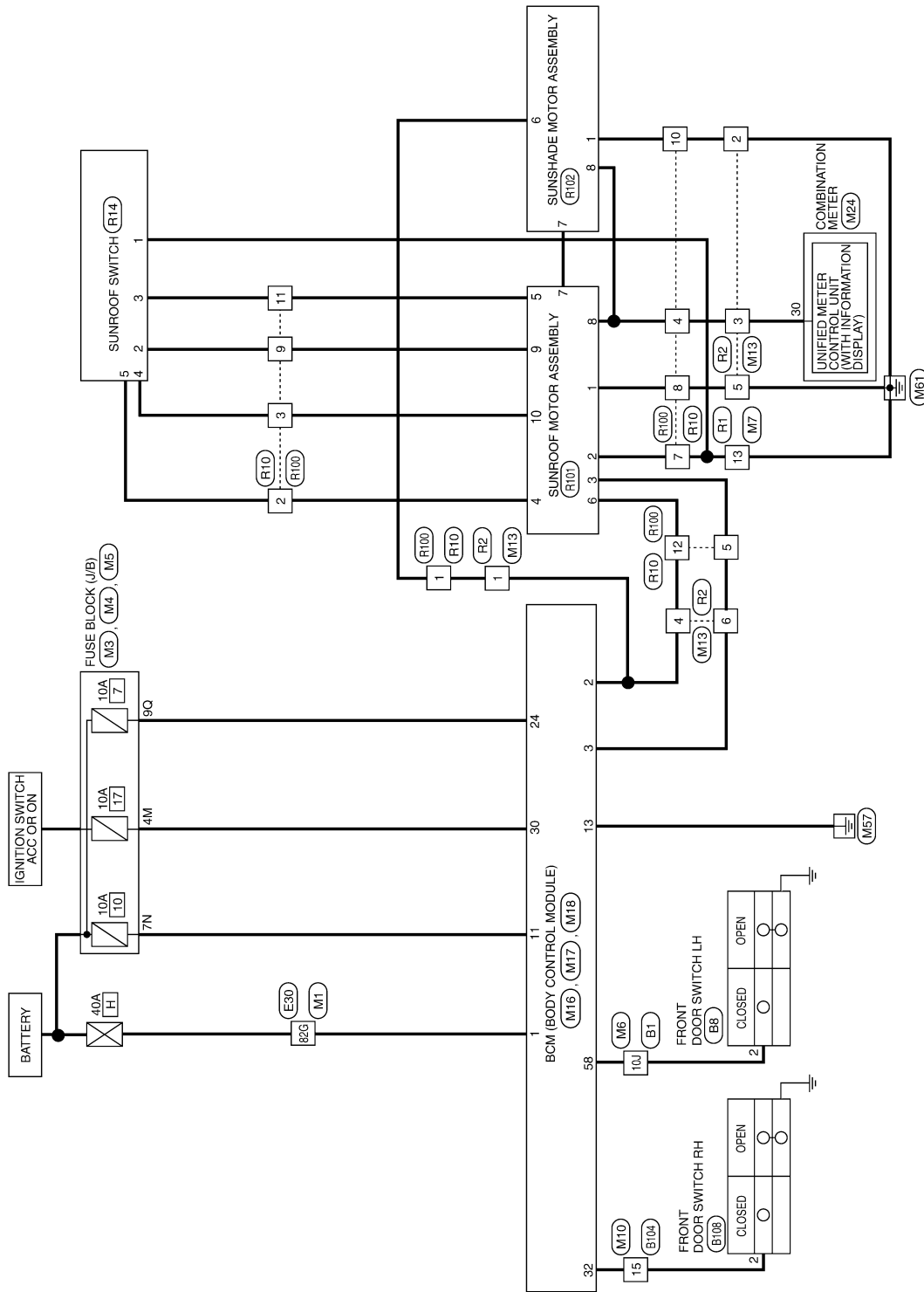

ABKWA0607GE

A  
B  
C  
D  
E  
F  
G  
H  
I  
J  
RF  
L  
M  
N  
O  
P

# SUNSHADE MOTOR ASSEMBLY

[WITH DUAL PANEL SUNROOF]

< ECU DIAGNOSIS >

## DUAL PANEL SUNROOF CONNECTORS

Connector No.	M1
Connector Name	WIRE TO WIRE
Connector Color	WHITE

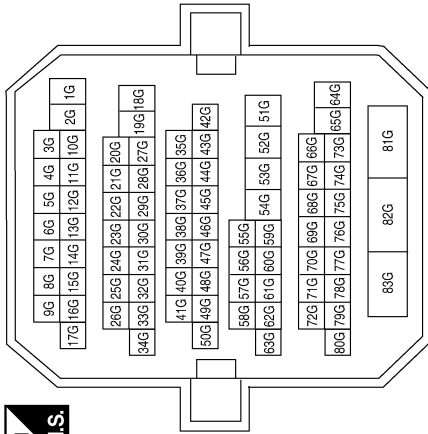

Terminal No.	82G	Color of Wire	W/B	Signal Name	-
--------------	-----	---------------	-----	-------------	---

Connector No.	M3
Connector Name	FUSE BLOCK (J/B)
Connector Color	WHITE

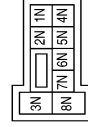

Terminal No.	7N	Color of Wire	Y/R	Signal Name	-
--------------	----	---------------	-----	-------------	---

Connector No.	M5
Connector Name	FUSE BLOCK (J/B)
Connector Color	WHITE



Connector No.	M4
Connector Name	FUSE BLOCK (J/B)
Connector Color	WHITE

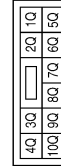

Terminal No.	4M	Color of Wire	V/Y	Signal Name	-
--------------	----	---------------	-----	-------------	---

Terminal No.	9Q	Color of Wire	R/W	Signal Name	-
--------------	----	---------------	-----	-------------	---

ABKIA1885GB

# SUNSHADE MOTOR ASSEMBLY

< ECU DIAGNOSIS >

[WITH DUAL PANEL SUNROOF]

Connector No.	M7
Connector Name	WIRE TO WIRE
Connector Color	WHITE

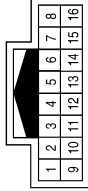

Terminal No.	13	Color of Wire	B	Signal Name	-
--------------	----	---------------	---	-------------	---

Terminal No.	10J	Color of Wire	SB	Signal Name	-
--------------	-----	---------------	----	-------------	---

Connector No.	M6
Connector Name	WIRE TO WIRE
Connector Color	WHITE

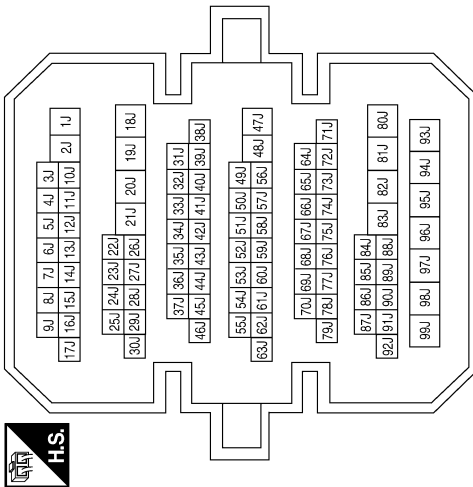

Connector No.	M16
Connector Name	BCM (BODY CONTROL MODULE)
Connector Color	BLACK



Terminal No.	1	Color of Wire	W/B	Signal Name	BATT (F/L)
2	R/Y	P/W POWER SUPPLY PERM			
3	L/W	P/W POWER SUPPLY IGN			

Connector No.	M13
Connector Name	WIRE TO WIRE
Connector Color	WHITE

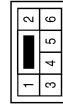

Terminal No.	1	Color of Wire	R/Y	Signal Name	-
2	B	-			
3	L/B	-			
4	R/Y	-			
5	B	-			
6	L/W	-			

Connector No.	M10
Connector Name	WIRE TO WIRE
Connector Color	WHITE

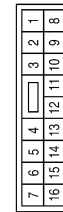

Terminal No.	15	Color of Wire	R/B	Signal Name	-
--------------	----	---------------	-----	-------------	---

ABKIA1141GB

A B C D E F G H I J L M N O P RF

# SUNSHADE MOTOR ASSEMBLY

[WITH DUAL PANEL SUNROOF]

< ECU DIAGNOSIS >

Connector No.	M17
Connector Name	BCM (BODY CONTROL MODULE)
Connector Color	WHITE

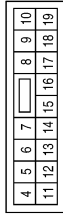

Terminal No.	Color of Wire	Signal Name
11	Y/R	BAT BCM FUSE
13	B	GND1

Connector No.	M18
Connector Name	BCM (BODY CONTROL MODULE)
Connector Color	GREEN



Terminal No.	Color of Wire	Signal Name
24	R/W	BRAKE SW 1
30	V/Y	ACC F/B
32	R/B	AS DOOR SW 1
58	SB	DR DOOR SW

Connector No.	M24
Connector Name	COMBINATION METER
Connector Color	WHITE



Terminal No.	Color of Wire	Signal Name
30	L/B	2P/R OUT

Connector No.	E30
Connector Name	WIRE TO WIRE
Connector Color	WHITE



Terminal No.	Color of Wire	Signal Name
82G	LG	-

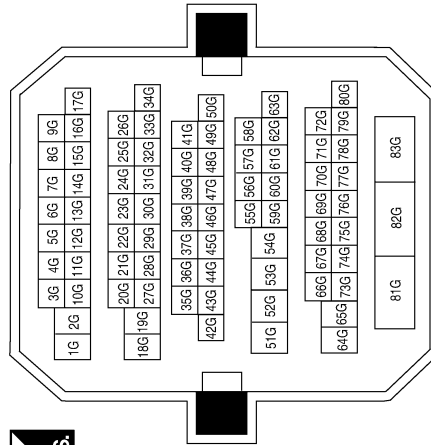

ABKIA1784GB

# SUNSHADE MOTOR ASSEMBLY

< ECU DIAGNOSIS >

[WITH DUAL PANEL SUNROOF]

Connector No.	B8
Connector Name	FRONT DOOR SWITCH LH
Connector Color	WHITE

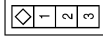

Terminal No.	Color of Wire	Signal Name
2	SB	-

Terminal No.	Color of Wire	Signal Name
10J	SB	-

Connector No.	B1
Connector Name	WIRE TO WIRE
Connector Color	WHITE

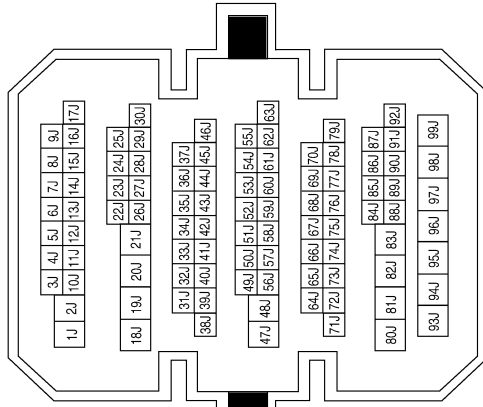

Connector No.	R1
Connector Name	WIRE TO WIRE
Connector Color	WHITE

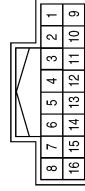

Terminal No.	Color of Wire	Signal Name
13	B	-

Connector No.	B108
Connector Name	FRONT DOOR SWITCH RH
Connector Color	WHITE



Terminal No.	Color of Wire	Signal Name
2	GR	-

Connector No.	B104
Connector Name	WIRE TO WIRE
Connector Color	WHITE



Terminal No.	Color of Wire	Signal Name
15	GR	-

ABKIA0427GB

A  
B  
C  
D  
E  
F  
G  
H  
I  
J  
RF  
L  
M  
N  
O  
P

# SUNSHADE MOTOR ASSEMBLY

[WITH DUAL PANEL SUNROOF]

< ECU DIAGNOSIS >

Connector No.	R14
Connector Name	SUNROOF SWITCH (WITH DUAL PANEL SUNROOF)
Connector Color	WHITE

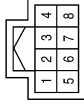

Terminal No.	Color of Wire	Signal Name
1	B	GND
2	G	AUTO 2nd
3	Y	OPEN SLIDE 1st
4	LG	CLOSE SLIDE 1st
5	W/R	PUSH

Connector No.	R10
Connector Name	WIRE TO WIRE
Connector Color	WHITE

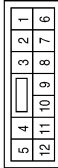

Terminal No.	Color of Wire	Signal Name
1	R	-
2	W/R	-
3	LG	-
4	L/B	-
5	L/W	-
7	B	-
8	B	-
9	G	-
10	B/L	-
11	Y	-
12	R/Y	-

Terminal No.	Color of Wire	Signal Name
8	B	-
9	W	-
10	B	-
11	LG	-
12	L	-

Connector No.	R2
Connector Name	WIRE TO WIRE
Connector Color	WHITE



Terminal No.	Color of Wire	Signal Name
1	R	-
2	B/L	-
3	L/B	-
4	R/Y	-
5	B	-
6	L/W	-

Connector No.	R100
Connector Name	WIRE TO WIRE
Connector Color	WHITE



Terminal No.	Color of Wire	Signal Name
1	G	-
2	Y	-
3	V	-
4	BR	-
5	R	-
7	O	-

ABKIA0428GB

# SUNSHADE MOTOR ASSEMBLY

< ECU DIAGNOSIS >

[WITH DUAL PANEL SUNROOF]

Connector No.	R102
Connector Name	SUNSHADE MOTOR ASSEMBLY
Connector Color	GRAY

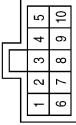

Terminal No.	Color of Wire	Signal Name
1	B	GND2
6	G	BATT 2
7	P	SERIAL
8	BR	SPEED (2P)

Connector No.	R101
Connector Name	SUNROOF MOTOR ASSEMBLY (WITH DUAL PANEL SUNROOF)
Connector Color	GRAY

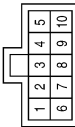

Terminal No.	Color of Wire	Signal Name
1	B	GND
2	O	-
3	R	IGN
4	Y	PUSH SW
5	LG	OPEN SW
6	L	BATT
7	P	SERIAL
8	BR	SPEED(2P)
9	W	2ND CLICK SW
10	V	CLOSE SW

A  
B  
C  
D  
E  
F  
G  
H  
I  
J  
RF  
L  
M  
N  
O  
P

ABKIA0429GB

# SUNROOF DOES NOT OPERATE PROPERLY

< SYMPTOM DIAGNOSIS >

[WITH DUAL PANEL SUNROOF]

## SYMPTOM DIAGNOSIS

### SUNROOF DOES NOT OPERATE PROPERLY

#### Diagnosis Procedure

INFOID:000000005461882

#### 1. CHECK SUNROOF MECHANISM

---

Check the following.

- Operation malfunction caused by sunroof mechanism deformation, pinched harness or other foreign materials
- Operation malfunction and interference with other parts by poor installation

Is the inspection result normal?

YES >> GO TO 2.

NO >> Repair or replace the malfunctioning parts.

#### 2. CHECK SUNROOF MOTOR ASSEMBLY POWER SUPPLY AND GROUND CIRCUIT

---

Check sunroof motor assembly power supply and ground circuit.

Refer to [RF-96, "SUNROOF MOTOR ASSEMBLY : Diagnosis Procedure"](#)

Is the inspection result normal?

YES >> GO TO 3.

NO >> Repair or replace the malfunctioning parts.

#### 3. CHECK SUNROOF SWITCH

---

Check sunroof switch.

Refer to [RF-100, "Diagnosis Procedure"](#).

Is the inspection result normal?

YES >> GO TO 4.

NO >> Repair or replace the malfunctioning parts.

#### 4. CONFIRM THE OPERATION

---

Confirm the operation again.

Is the result normal?

YES >> Check intermittent incident. Refer to [GI-39, "Intermittent Incident"](#).

NO >> GO TO 1.



# SUNSHADE SYSTEM DOES NOT OPERATE PROPERLY

< SYMPTOM DIAGNOSIS >

[WITH DUAL PANEL SUNROOF]

## SUNSHADE SYSTEM DOES NOT OPERATE PROPERLY

### Diagnosis Procedure

INFOID:000000005461883

#### 1.CHECK SUNSHADE MECHANISM

Check the following.

- Operation malfunction caused by sunshade mechanism deformation, pinched harness or other foreign materials
- Operation malfunction and interference with other parts by poor installation

Is the inspection result normal?

YES >> GO TO 2.

NO >> Repair or replace the malfunctioning parts.

#### 2.CHECK SUNSHADE MOTOR ASSEMBLY POWER SUPPLY AND GROUND CIRCUIT

Check sunshade motor assembly power supply and ground circuit.

Refer to [RF-97. "SUNSHADE MOTOR ASSEMBLY : Diagnosis Procedure"](#).

Is the inspection result normal?

YES >> GO TO 3.

NO >> Repair or replace the malfunctioning parts.

#### 3.CHECK COMMUNICATION CIRCUIT

Check communication circuit.

Refer to [RF-99. "Diagnosis Procedure"](#).

Is the inspection result normal?

YES >> GO TO 4.

NO >> Repair or replace the harness.

#### 4.CONFIRM THE OPERATION

Confirm the operation again.

Is the result normal?

YES >> Check intermittent incident. Refer to [GI-39. "Intermittent Incident"](#).

NO >> GO TO 1.

A  
B  
C  
D  
E  
F  
G  
H  
I  
J  
L  
M  
N  
O  
P

RF

# AUTO OPERATION DOES NOT OPERATE

< SYMPTOM DIAGNOSIS >

[WITH DUAL PANEL SUNROOF]

## AUTO OPERATION DOES NOT OPERATE

### Diagnosis Procedure

INFOID:000000005461884

#### 1.PERFORM INITIALIZATION PROCEDURE

---

Initialization procedure is executed and operation is confirmed.

Refer to [RF-88. "ADDITIONAL SERVICE WHEN REPLACING CONTROL UNIT : Special Repair Requirement"](#).

Is the inspection result normal?

YES >> Sunroof and sunshade system is normal.

NO >> GO TO 2.

#### 2.CHECK SUNROOF SWITCH

---

Check sunroof switch.

Refer to [RF-100. "Diagnosis Procedure"](#).

Is the inspection result normal?

YES >> GO TO 3.

NO >> Repair or replace the malfunctioning parts.

#### 3.CONFIRM THE OPERATION

---

Confirm the operation again.

Is the result normal?

YES >> Check intermittent incident. Refer to [GI-39. "Intermittent Incident"](#).

NO >> GO TO 1.

# RETAINED POWER OPERATION DOES NOT OPERATE PROPERLY

< SYMPTOM DIAGNOSIS >

[WITH DUAL PANEL SUNROOF]

## RETAINED POWER OPERATION DOES NOT OPERATE PROPERLY

### Diagnosis Procedure

INFOID:000000005461885

#### 1.CHECK FRONT DOOR SWITCH

Check front door switch.

Refer to [DLK-68. "Diagnosis Procedure"](#).

Is the inspection result normal?

YES >> GO TO 2.

NO >> Repair or replace the malfunctioning parts.

#### 2.CONFIRM THE OPERATION

Confirm the operation again.

Is the result normal?

YES >> Check intermittent incident. Refer to [GI-39. "Intermittent Incident"](#).

NO >> GO TO 1.

A  
B  
C  
D  
E  
F  
G  
H  
I  
J  
RF  
L  
M  
N  
O  
P

# ANTI-PINCH FUNCTION DOES NOT OPERATE

< SYMPTOM DIAGNOSIS >

[WITH DUAL PANEL SUNROOF]

## ANTI-PINCH FUNCTION DOES NOT OPERATE

### Diagnosis Procedure

INFOID:000000005461886

#### 1.CHECK SUNROOF AND SUNSHADE MECHANISM

---

Check the following.

- Operation malfunction caused by sunroof and sunshade mechanism deformation, pinched harness or other foreign materials
- Operation malfunction and interference with other parts by poor installation

Is the inspection result normal?

YES >> GO TO 2.

NO >> Repair or replace the malfunctioning parts.

#### 2.PERFORM INITIALIZATION

---

Perform initialization procedure.

Refer to [RF-88. "ADDITIONAL SERVICE WHEN REPLACING CONTROL UNIT : Special Repair Requirement"](#).

Is the inspection result normal?

YES >> Sunroof and sunshade system is normal.

NO >> GO TO 1.

# SQUEAK AND RATTLE TROUBLE DIAGNOSES

< SYMPTOM DIAGNOSIS >

[WITH DUAL PANEL SUNROOF]

## SQUEAK AND RATTLE TROUBLE DIAGNOSES

### Work Flow

INFOID:000000005485378

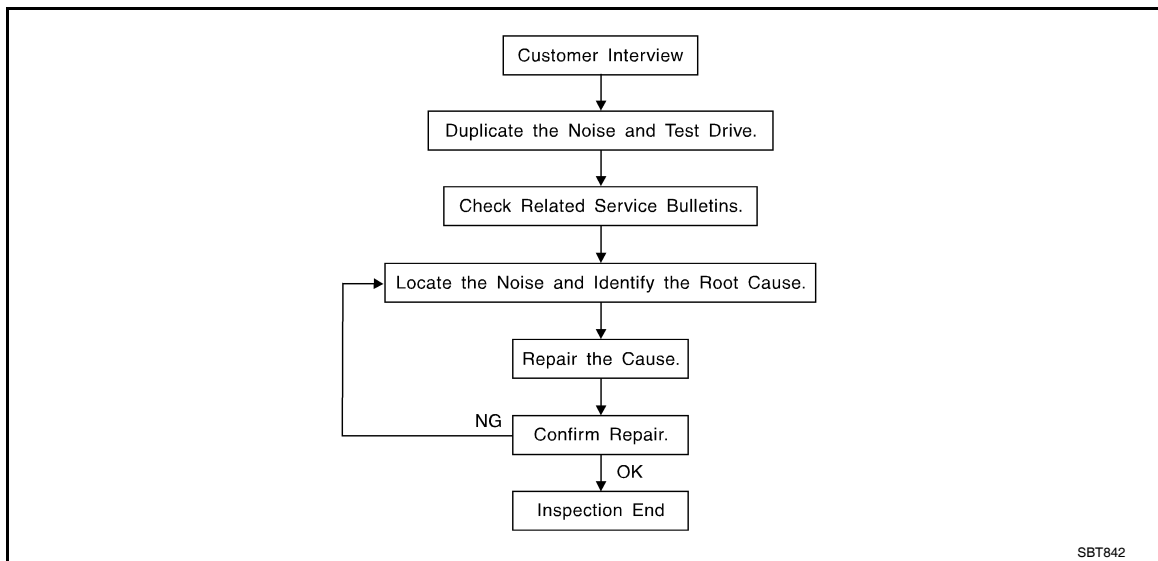

### CUSTOMER INTERVIEW

Interview the customer if possible, to determine the conditions that exist when the noise occurs. Use the Diagnostic Worksheet during the interview to document the facts and conditions when the noise occurs and any customer's comments; refer to [IP-6, "Diagnostic Worksheet"](#). This information is necessary to duplicate the conditions that exist when the noise occurs.

- The customer may not be able to provide a detailed descriptions or the location of the noise. Attempt to obtain all the facts and conditions that exist when the noise occurs (or does not occur).
- If there is more than one noise in the vehicle, be sure to diagnose and repair the noise that the customer is concerned about. This can be accomplished by test driving the vehicle with the customer.
- After identifying the type of noise, isolate the noise in terms of its characteristics. The noise characteristics are provided so the customer, service adviser and technician are all speaking the same language when defining the noise.
- Squeak —(Like tennis shoes on a clean floor)  
Squeak characteristics include the light contact/fast movement/brought on by road conditions/hard surfaces = higher pitch noise/softer surfaces = lower pitch noises/edge to surface = chirping
- Creak—(Like walking on an old wooden floor)  
Creak characteristics include firm contact/slow movement/twisting with a rotational movement/pitch dependent on materials/often brought on by activity.
- Rattle—(Like shaking a baby rattle)  
Rattle characteristics include the fast repeated contact/vibration or similar movement/loose parts/missing clip or fastener/incorrect clearance.
- Knock —(Like a knock on a door)  
Knock characteristics include hollow sounding/sometimes repeating/often brought on by driver action.
- Tick—(Like a clock second hand)  
Tick characteristics include gentle contacting of light materials/loose components/can be caused by driver action or road conditions.
- Thump—(Heavy, muffled knock noise)  
Thump characteristics include softer knock/dead sound often brought on by activity.
- Buzz—(Like a bumble bee)  
Buzz characteristics include high frequency rattle/firm contact.
- Often the degree of acceptable noise level will vary depending upon the person. A noise that you may judge as acceptable may be very irritating to the customer.
- Weather conditions, especially humidity and temperature, may have a great effect on noise level.

### DUPLICATE THE NOISE AND TEST DRIVE

If possible, drive the vehicle with the customer until the noise is duplicated. Note any additional information on the Diagnostic Worksheet regarding the conditions or location of the noise. This information can be used to duplicate the same conditions when you confirm the repair.

# SQUEAK AND RATTLE TROUBLE DIAGNOSES

[WITH DUAL PANEL SUNROOF]

## < SYMPTOM DIAGNOSIS >

If the noise can be duplicated easily during the test drive, to help identify the source of the noise, try to duplicate the noise with the vehicle stopped by doing one or all of the following:

- 1) Close a door.
  - 2) Tap or push/pull around the area where the noise appears to be coming from.
  - 3) Rev the engine.
  - 4) Use a floor jack to recreate vehicle "twist".
  - 5) At idle, apply engine load (with brakes applied, place CVT shift selector in drive position).
  - 6) Raise the vehicle on a hoist and hit a tire with a rubber hammer.
- Drive the vehicle and attempt to duplicate the conditions the customer states exist when the noise occurs.
  - If it is difficult to duplicate the noise, drive the vehicle slowly on an undulating or rough road to stress the vehicle body.

## CHECK RELATED SERVICE BULLETINS

After verifying the customer concern or symptom, check ASIST for Technical Service Bulletins (TSBs) related to that concern or symptom.

If a TSB relates to the symptom, follow the procedure to repair the noise.

## LOCATE THE NOISE AND IDENTIFY THE ROOT CAUSE

1. Narrow down the noise to a general area. To help pinpoint the source of the noise, use a listening tool (Chassis Ear: J-39570, Engine Ear and mechanics stethoscope).
2. Narrow down the noise to a more specific area and identify the cause of the noise by:
  - removing the components in the area that you suspect the noise is coming from.  
Do not use too much force when removing clips and fasteners, otherwise clips and fastener can be broken or lost during the repair, resulting in the creation of new noise.
  - tapping or pushing/pulling the component that you suspect is causing the noise.  
Do not tap or push/pull the component with excessive force, otherwise the noise will be eliminated only temporarily.
  - feeling for a vibration with your hand by touching the component(s) that you suspect is (are) causing the noise.
  - placing a piece of paper between components that you suspect are causing the noise.
  - looking for loose components and contact marks.  
Refer to [RF-167. "Generic Squeak and Rattle Troubleshooting"](#).

## REPAIR THE CAUSE

- If the cause is a loose component, tighten the component securely.
- If the cause is insufficient clearance between components:
  - separate components by repositioning or loosening and retightening the component, if possible.
  - insulate components with a suitable insulator such as urethane pads, foam blocks, felt cloth tape or urethane tape. A Nissan Squeak and Rattle Kit (J-43980) is available through your authorized Nissan Parts Department.

### **CAUTION:**

**Do not use excessive force as many components are constructed of plastic and may be damaged.**

### **NOTE:**

Always check with the Parts Department for the latest parts information.

The following materials are contained in the Nissan Squeak and Rattle Kit (J-43980). Each item can be ordered separately as needed.

URETHANE PADS [1.5 mm (0.059 in) thick]

Insulates connectors, harness, etc.

76268-9E005: 100 × 135 mm (3.94 × 5.31 in)/76884-71L01: 60 × 85 mm (2.36 × 3.35 in)/76884-71L02: 15 × 25 mm (0.59 × 0.98 in)

INSULATOR (Foam blocks)

Insulates components from contact. Can be used to fill space behind a panel.

73982-9E000: 45 mm (1.77 in) thick, 50 × 50 mm (1.97 × 1.97 in)/73982-

50Y00: 10 mm (0.39 in) thick, 50 × 50 mm (1.97 × 1.97 in)

INSULATOR (Light foam block)

80845-71L00: 30 mm (1.18 in) thick, 30 × 50 mm (1.18 × 1.97in)

FELT CLOTH TAPE

Used to insulate where movement does not occur. Ideal for instrument panel applications.

68370-4B000: 15 × 25 mm (0.59 × 0.98 in) pad/68239-13E00: 5 mm (0.20 in) wide tape roll

The following materials, not found in the kit, can also be used to repair squeaks and rattles.

UHMW (TEFLON) TAPE

# SQUEAK AND RATTLE TROUBLE DIAGNOSES

[WITH DUAL PANEL SUNROOF]

## < SYMPTOM DIAGNOSIS >

Insulates where slight movement is present. Ideal for instrument panel applications.

### SILICONE GREASE

Used in place of UHMW tape that will be visible or not fit. Will only last a few months.

### SILICONE SPRAY

Use when grease cannot be applied.

### DUCT TAPE

Use to eliminate movement.

## CONFIRM THE REPAIR

Confirm that the cause of a noise is repaired by test driving the vehicle. Operate the vehicle under the same conditions as when the noise originally occurred. Refer to the notes on the Diagnostic Worksheet.

## Generic Squeak and Rattle Troubleshooting

INFOID:000000005485379

Refer to Table of Contents for specific component removal and installation information.

## INSTRUMENT PANEL

Most incidents are caused by contact and movement between:

1. Acrylic lens and combination meter housing
2. Instrument panel to front pillar finishers
3. Instrument panel to windshield
4. Instrument panel mounting pins
5. Wiring harnesses behind the combination meter
6. A/C defroster duct and duct joint

These incidents can usually be located by tapping or moving the components to duplicate the noise or by pressing on the components while driving to stop the noise. Most of these incidents can be repaired by applying felt cloth tape or silicone spray (in hard to reach areas). Urethane pads can be used to insulate wiring harness.

### **CAUTION:**

**Do not use silicone spray to isolate a squeak or rattle. If you saturate the area with silicone, you will not be able to recheck the repair.**

## CENTER CONSOLE

Components to pay attention to include:

1. Shifter assembly cover to finisher
2. A/C control unit and cluster lid C
3. Wiring harnesses behind audio and A/C control unit

The instrument panel repair and isolation procedures also apply to the center console.

## DOORS

Pay attention to the:

1. Finisher and inner panel making a slapping noise
2. Inside handle escutcheon to door finisher
3. Wiring harnesses tapping
4. Door striker out of alignment causing a popping noise on starts and stops

Tapping or moving the components or pressing on them while driving to duplicate the conditions can isolate many of these incidents. You can usually insulate the areas with felt cloth tape or insulator foam blocks from the Nissan Squeak and Rattle Kit (J-43980) to repair the noise.

## TRUNK

Trunk noises are often caused by a loose jack or loose items put into the trunk by the owner.

In addition look for:

1. Trunk lid bumpers out of adjustment
2. Trunk lid striker out of adjustment
3. The trunk lid torsion bars knocking together
4. A loose license plate or bracket

Most of these incidents can be repaired by adjusting, securing or insulating the item(s) or component(s) causing the noise.

A  
B  
C  
D  
E  
F  
G  
H  
I  
J  
L  
M  
N  
O  
P

RF

# SQUEAK AND RATTLE TROUBLE DIAGNOSES

< SYMPTOM DIAGNOSIS >

[WITH DUAL PANEL SUNROOF]

## SUNROOF/HEADLINING

Noises in the sunroof/headlining area can often be traced to one of the following:

1. Sunroof lid, rail, linkage or seals making a rattle or light knocking noise
2. Sunvisor shaft shaking in the holder
3. Front or rear windshield touching headlining and squeaking

Again, pressing on the components to stop the noise while duplicating the conditions can isolate most of these incidents. Repairs usually consist of insulating with felt cloth tape.

## OVERHEAD CONSOLE (FRONT AND REAR)

Overhead console noises are often caused by the console panel clips not being engaged correctly. Most of these incidents are repaired by pushing up on the console at the clip locations until the clips engage.

In addition, look for:

1. Loose harness or harness connectors.
2. Front console map/reading lamp lens loose.
3. Loose screws at console attachment points.

## SEATS

When isolating seat noise it's important to note the position the seat is in and the load placed on the seat when the noise is present. These conditions should be duplicated when verifying and isolating the cause of the noise.

Cause of seat noise include:

1. Headrest rods and holder
2. A squeak between the seat pad cushion and frame
3. The rear seatback lock and bracket

These noises can be isolated by moving or pressing on the suspected components while duplicating the conditions under which the noise occurs. Most of these incidents can be repaired by repositioning the component or applying urethane tape to the contact area.

## UNDERHOOD

Some interior noise may be caused by components under the hood or on the engine wall. The noise is then transmitted into the passenger compartment.

Causes of transmitted underhood noise include:

1. Any component mounted to the engine wall
2. Components that pass through the engine wall
3. Engine wall mounts and connectors
4. Loose radiator mounting pins
5. Hood bumpers out of adjustment
6. Hood striker out of adjustment

These noises can be difficult to isolate since they cannot be reached from the interior of the vehicle. The best method is to secure, move or insulate one component at a time and test drive the vehicle. Also, engine RPM or load can be changed to isolate the noise. Repairs can usually be made by moving, adjusting, securing, or insulating the component causing the noise.



# SQUEAK AND RATTLE TROUBLE DIAGNOSES

< SYMPTOM DIAGNOSIS >

[WITH DUAL PANEL SUNROOF]

## Diagnostic Worksheet

INFOID:000000005461889

Dear Customer:

We are concerned about your satisfaction with your vehicle. Repairing a squeak or rattle sometimes can be very difficult. To help us fix your vehicle right the first time, please take a moment to note the area of the vehicle where the squeak or rattle occurs and under what conditions. You may be asked to take a test drive with a service advisor or technician to ensure we confirm the noise you are hearing.

### SQUEAK & RATTLE DIAGNOSTIC WORKSHEET

#### I. WHERE DOES THE NOISE COME FROM? (circle the area of the vehicle)

The illustrations are for reference only, and may not reflect the actual configuration of your vehicle.

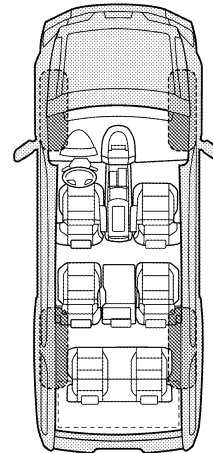
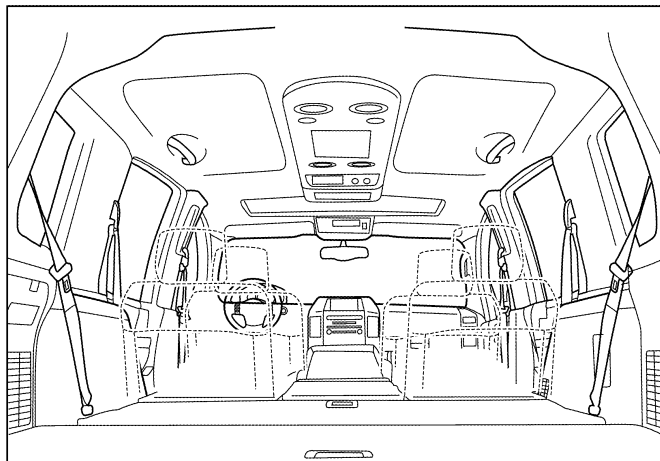
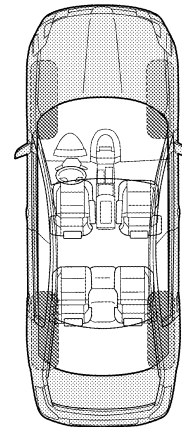
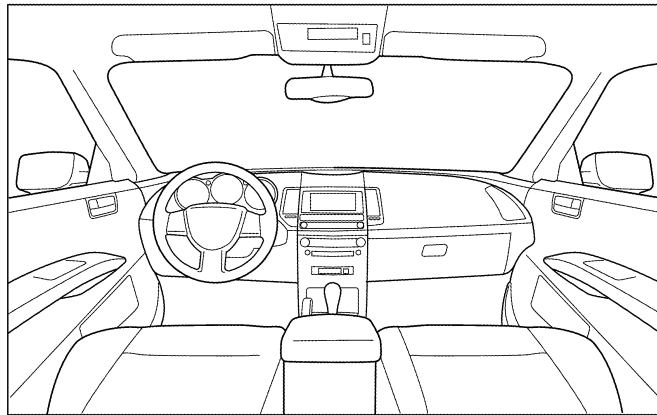

Continue to page 2 of the worksheet and briefly describe the location of the noise or rattle. In addition, please indicate the conditions which are present when the noise occurs.

A  
B  
C  
D  
E  
F  
G  
H  
I  
J  
RF  
L  
M  
N  
O  
P

# SQUEAK AND RATTLE TROUBLE DIAGNOSES

< SYMPTOM DIAGNOSIS >

[WITH DUAL PANEL SUNROOF]

## SQUEAK & RATTLE DIAGNOSTIC WORKSHEET - page 2

Briefly describe the location where the noise occurs:

---

---

### II. WHEN DOES IT OCCUR? (please check the boxes that apply)

- |   |  |
|---|--|
| <input type="checkbox"/> Anytime                      | <input type="checkbox"/> After sitting out in the rain |
| <input type="checkbox"/> 1st time in the morning      | <input type="checkbox"/> When it is raining or wet     |
| <input type="checkbox"/> Only when it is cold outside | <input type="checkbox"/> Dry or dusty conditions       |
| <input type="checkbox"/> Only when it is hot outside  | <input type="checkbox"/> Other:                        |

### III. WHEN DRIVING:

- Through driveways
- Over rough roads
- Over speed bumps
- Only about \_\_\_\_ mph
- On acceleration
- Coming to a stop
- On turns: left, right or either (circle)
- With passengers or cargo
- Other: \_\_\_\_\_
- After driving \_\_\_\_ miles or \_\_\_\_ minutes

### IV. WHAT TYPE OF NOISE

- Squeak (like tennis shoes on a clean floor)
- Creak (like walking on an old wooden floor)
- Rattle (like shaking a baby rattle)
- Knock (like a knock at the door)
- Tick (like a clock second hand)
- Thump (heavy muffled knock noise)
- Buzz (like a bumble bee)

### TO BE COMPLETED BY DEALERSHIP PERSONNEL

#### Test Drive Notes:

---

---

---

	YES	NO	Initials of person performing
Vehicle test driven with customer	<input type="checkbox"/>	<input type="checkbox"/>	_____
- Noise verified on test drive	<input type="checkbox"/>	<input type="checkbox"/>	_____
- Noise source located and repaired	<input type="checkbox"/>	<input type="checkbox"/>	_____
- Follow up test drive performed to confirm repair	<input type="checkbox"/>	<input type="checkbox"/>	_____

VIN: \_\_\_\_\_ Customer Name \_\_\_\_\_

W.O.# \_\_\_\_\_ Date: \_\_\_\_\_

This form must be attached to Work Order

LAI0071E

< PRECAUTION >

# PRECAUTION

## PRECAUTIONS

### Precaution for Supplemental Restraint System (SRS) "AIR BAG" and "SEAT BELT PRE-TENSIONER"

INFOID:000000005461890

The Supplemental Restraint System such as "AIR BAG" and "SEAT BELT PRE-TENSIONER", used along with a front seat belt, helps to reduce the risk or severity of injury to the driver and front passenger for certain types of collision. This system includes seat belt switch inputs and dual stage front air bag modules. The SRS system uses the seat belt switches to determine the front air bag deployment, and may only deploy one front air bag, depending on the severity of a collision and whether the front occupants are belted or unbelted. Information necessary to service the system safely is included in the SR and SB section of this Service Manual.

**WARNING:**

- To avoid rendering the SRS inoperative, which could increase the risk of personal injury or death in the event of a collision which would result in air bag inflation, all maintenance must be performed by an authorized NISSAN/INFINITI dealer.
- Improper maintenance, including incorrect removal and installation of the SRS, can lead to personal injury caused by unintentional activation of the system. For removal of Spiral Cable and Air Bag Module, see the SR section.
- Do not use electrical test equipment on any circuit related to the SRS unless instructed to in this Service Manual. SRS wiring harnesses can be identified by yellow and/or orange harnesses or harness connectors.

### PRECAUTIONS WHEN USING POWER TOOLS (AIR OR ELECTRIC) AND HAMMERS

**WARNING:**

- When working near the Airbag Diagnosis Sensor Unit or other Airbag System sensors with the Ignition ON or engine running, DO NOT use air or electric power tools or strike near the sensor(s) with a hammer. Heavy vibration could activate the sensor(s) and deploy the air bag(s), possibly causing serious injury.
- When using air or electric power tools or hammers, always switch the Ignition OFF, disconnect the battery, and wait at least 3 minutes before performing any service.

### Precautions

INFOID:000000005461891

- After removing and installing any opening/closing parts, make sure to perform all adjustments for proper operation.
- Check the lubrication level, damage, and wear of each part. If necessary, grease or replace it.
- When removing or disassembling any part, be careful not to damage or deform it. Protect parts which may get in the way with cloth.
- When removing parts with a screw driver or other tool, protect parts by wrapping them with vinyl or tape.
- Keep removed parts protected with cloth.
- If a clip is deformed or damaged, replace it.
- If a non-reuseable part is removed, replace it with a new one.
- Tighten bolts and nuts firmly to the specified torque.
- After re-assembly has been completed, make sure each part functions correctly.
- Remove stains in the following manner:

Water-Soluble stains	Oil stains
Dip a cloth in warm water, and squeeze tightly. After wiping the stain, wipe with a soft dry cloth.	Dissolve a synthetic detergent in warm water (density of 2 to 3% or less), dip the cloth, then clean off the stain with the cloth. Next, dip the cloth in fresh water, then squeeze tightly. Clean off detergent completely, then wipe entire area with a soft dry cloth.
Do not use any organic solvent, such as a thinner or benzine to remove stains	

### Precautions Necessary for Steering Wheel Rotation after Battery Disconnect (Early

A  
B  
C  
D  
E  
F  
G  
H  
I  
J  
RF  
L  
M  
N  
O  
P

# PRECAUTIONS

[WITH DUAL PANEL SUNROOF]

< PRECAUTION >

## Production, With Electronic Steering Column Lock)

INFOID:000000005885939

### NOTE:

- Before removing and installing any control units, first turn the push-button ignition switch to the LOCK position, then disconnect both battery cables.
- After finishing work, confirm that all control unit connectors are connected properly, then re-connect both battery cables.
- Always use CONSULT-III to perform self-diagnosis as a part of each function inspection after finishing work. If a DTC is detected, perform trouble diagnosis according to self-diagnosis results.

This vehicle is equipped with a push-button ignition switch and a steering lock unit.

If the battery is disconnected or discharged, the steering wheel will lock and cannot be turned.

If turning the steering wheel is required with the battery disconnected or discharged, follow the procedure below before starting the repair operation.

### OPERATION PROCEDURE

1. Connect both battery cables.

#### NOTE:

Supply power using jumper cables if battery is discharged.

2. Carry the Intelligent Key or insert it to the key slot and turn the push-button ignition switch to ACC position. (At this time, the steering lock will be released.)
3. Disconnect both battery cables. The steering lock will remain released with both battery cables disconnected and the steering wheel can be turned.
4. Perform the necessary repair operation.
5. When the repair work is completed, re-connect both battery cables. With the brake pedal released, turn the push-button ignition switch from ACC position to ON position, then to LOCK position. (The steering wheel will lock when the push-button ignition switch is turned to LOCK position.)
6. Perform self-diagnosis check of all control units using CONSULT-III.

# PREPARATION

< PREPARATION >

[WITH DUAL PANEL SUNROOF]

## PREPARATION

### PREPARATION

#### Special Service Tools

INFOID:000000005461893

The actual shapes of Kent-Moore tools may differ from those of special service tools illustrated here.

Tool number (Kent-Moore No.) Tool name	Description
— (J39570) Chassis ear	Locating the noise
— (J43980) NISSAN Squeak and Rattle Kit	Repairing the cause of noise

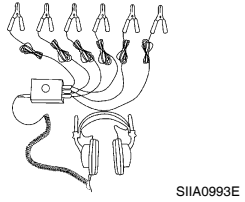

SIIA0993E

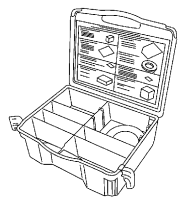

SIIA0994E

#### Commercial Service Tools

INFOID:000000005461894

Tool name (Kent-Moore No.)	Description
Engine ear (J-39565)	Locating the noise
Remover tools ( — )	Removing the clips, pawls and metal clips

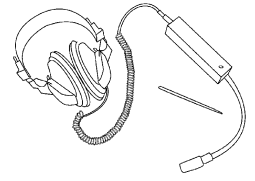

SIIA0995E

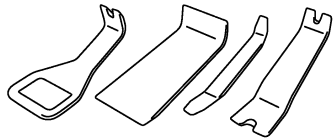

PIIB7923J

## ON-VEHICLE REPAIR

## GLASS LID

## Removal and Installation

INFOID:000000005461895

## REMOVAL

**CAUTION:**

- Always work with a helper.
- Handle glass lid with care to prevent damage.

**NOTE:**

For easier and more accurate installation, always mark each point before removal.

1. Open sunshade assembly.
2. Tilt glass lid up, then slide rearward to expose all the glass lid bolts.
3. Release the slide clip, then remove inner blind (1) RH/LH from the glass lid (2).

← : Front

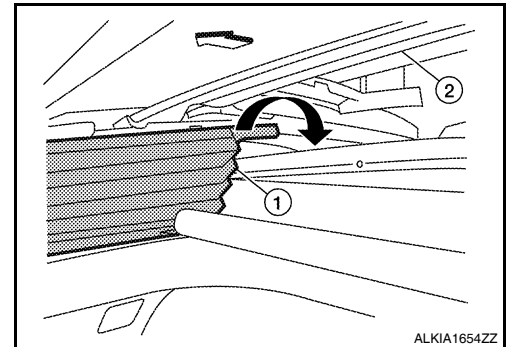

4. Remove the glass lid rear bolts (A), two on both the left and right sides.

← : Front

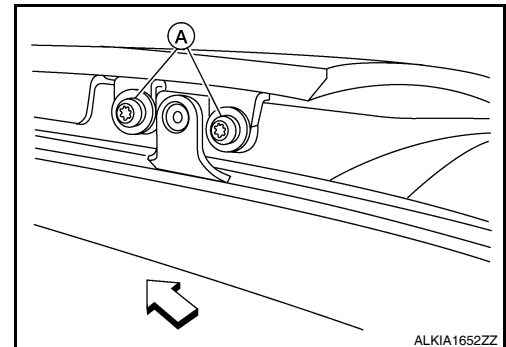

5. Remove the glass lid front bolts (B), two on both the left and right sides.

← : Front

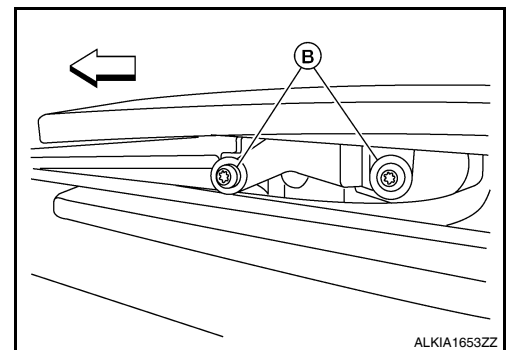

6. Remove the glass lid from the vehicle.

## INSTALLATION

**CAUTION:**

After installing the glass lid, perform the water leak test.

Installation is in the reverse order of removal.

**NOTE:**

- After installing, perform glass lid adjustment procedure. Refer to [RF-179, "Inspection and Adjustment"](#).

# GLASS LID

[WITH DUAL PANEL SUNROOF]

< ON-VEHICLE REPAIR >

- After adjustment, always check for proper sunroof operation. If necessary, perform initialization procedure to synchronize entire system. Refer to [RF-88, "ADDITIONAL SERVICE WHEN REPLACING CONTROL UNIT : Special Repair Requirement"](#).

A

B

C

D

E

F

G

H

I

J

RF

L

M

N

O

P

# SUNROOF MOTOR ASSEMBLY

< ON-VEHICLE REPAIR >

[WITH DUAL PANEL SUNROOF]

## SUNROOF MOTOR ASSEMBLY

### Removal and Installation

INFOID:000000005461896

#### REMOVAL

##### CAUTION:

- Before removing sunroof motor, check that glass lid is fully closed.
- After removing sunroof motor, do not attempt to rotate sunroof motor assembly as a single unit.

1. Close glass lid.
2. Remove the headlining. Refer to [INT-32, "Removal and Installation"](#).
3. Disconnect sunroof motor assembly harness connector (A).
4. Remove sunroof motor assembly screws (B), then remove sunroof motor assembly (1) from sunroof unit assembly frame.

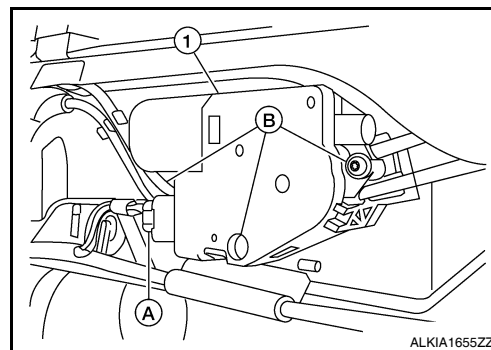

#### INSTALLATION

##### CAUTION:

**Before installing the sunroof motor assembly, be sure to place the link and wire assembly in the symmetrical and fully closed position.**

1. Move the sunroof motor assembly laterally so that the gear is completely engaged into the wire on the sunroof unit assembly frame, and mounting surface becomes parallel.
2. Install and tighten sunroof motor assembly screws.
3. Connect the sunroof motor assembly harness connector.
4. Install the headlining. Refer to [INT-32, "Removal and Installation"](#).
5. Perform initialization procedure. Refer to [RF-88, "ADDITIONAL SERVICE WHEN REPLACING CONTROL UNIT : Special Repair Requirement"](#).



# SUNSHADE MOTOR ASSEMBLY

< ON-VEHICLE REPAIR >

[WITH DUAL PANEL SUNROOF]

## SUNSHADE MOTOR ASSEMBLY

### Removal and Installation

INFOID:000000005461897

#### REMOVAL

##### CAUTION:

- Before removing sunshade motor, check that glass lid is fully closed.
- After removing sunshade motor, do not attempt to rotate sunshade motor assembly as a single unit.

1. Close glass lid.
2. Remove the headlining. Refer to [INT-32, "Removal and Installation"](#).
3. Disconnect sunshade motor assembly harness connector (A).
4. Remove sunroof motor assembly screws (B), then remove sunroof motor assembly (1) from sunroof unit assembly frame.

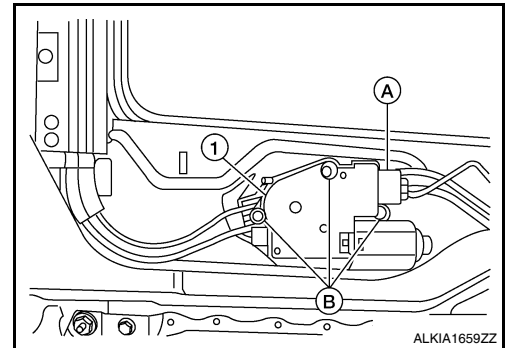

#### INSTALLATION

##### CAUTION:

**Before installing the sunshade motor assembly, be sure to place the link and wire assembly in the symmetrical and fully closed position.**

1. Move the sunshade motor assembly laterally so that the gear is completely engaged into the wire on the sunroof unit assembly frame, and mounting surface becomes parallel.
2. Install and tighten sunshade motor assembly screws.
3. Connect the sunshade motor assembly harness connector.
4. Install the headlining. Refer to [INT-32, "Removal and Installation"](#).
5. Perform initialization procedure. Refer to [RF-88, "ADDITIONAL SERVICE WHEN REPLACING CONTROL UNIT : Special Repair Requirement"](#).

## ROOF LINK ASSEMBLY

### Removal and Installation

INFOID:000000005461898

#### Removal

1. Remove the sunshade assembly. Refer to [RF-193, "Removal and Installation"](#).
2. Remove the wind deflector. Refer to [RF-192, "Removal and Installation"](#).
3. Remove the glass lid assembly. Refer to [RF-174, "Removal and Installation"](#).
4. Remove the sunroof motor. Refer to [RF-176, "Removal and Installation"](#).
5. Remove the sunshade motor. Refer to [RF-177, "Removal and Installation"](#).
6. Remove the track assembly.
  - Remove the 5 screws and 4 harness clips (LH).
  - Remove the 5 screws (RH).
7. Slide the guide link out of the channels.

#### Installation

1. Installation is in the reverse order of removal.

# SUNROOF UNIT ASSEMBLY

< ON-VEHICLE REPAIR >

[WITH DUAL PANEL SUNROOF]

## SUNROOF UNIT ASSEMBLY

### Inspection and Adjustment

INFOID:000000005461899

#### INSPECTION

##### Wind Deflector

1. Open glass lid assembly fully.
2. Visually check for proper installation, damaged/deteriorated components, or foreign objects within mechanism. Correct as required for smooth operation.
3. Check for grease at the wind deflector arm (1) and pivot areas. If necessary, apply a sufficient amount of grease for non-binding operation.

⇐ : Front

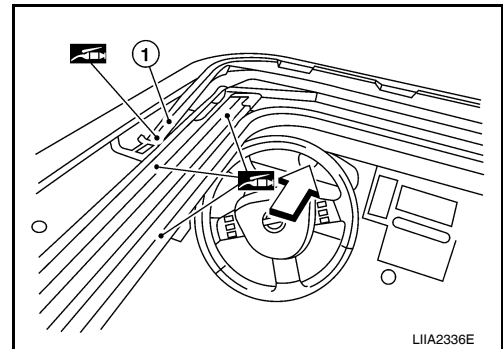

4. Check that the wind deflector (1) moves freely within the sunroof unit assembly while manually pressing down and releasing. If a malfunction is detected, remove the sunroof unit assembly and visually inspect; refer to [RF-182, "Removal and Installation"](#). If damage is found, replace either wind deflector (1) or sunroof unit assembly as required.

⇐ : Front

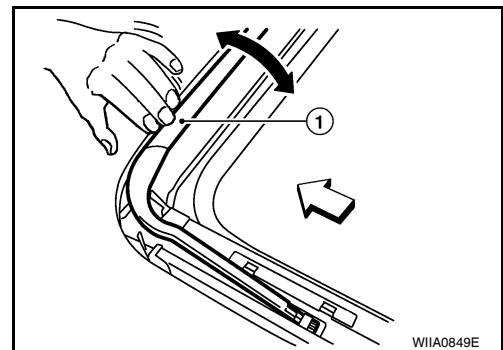

##### Link And Wire Assembly

#### NOTE:

Before replacing a suspect part, make sure it is the source of noise being experienced.

1. Check link to determine if coating film has peeled off excessively enough that substrate is visible. Check also to determine if link is the source of noise. Replace as necessary.
2. Visually check to determine if a sufficient amount of grease has been applied to wire or rail groove. If not, add grease as required.
3. Check wire for any damage or deterioration.

##### Weatherstrip

1. Visually check weatherstrip for damage, deterioration, or deformation.
  - Open glass lid partially to inspect front edge of weatherstrip.
  - Tilt up glass lid fully to inspect sides and rear edge of weatherstrip.If any area of the weatherstrip is found to be damaged, replace as required.
2. Check for leakage around glass lid assembly.
  - Close glass lid assembly.
  - Pour water around surface to determine area of concern.
  - For gaps or misalignment, adjust glass lid to specifications. Refer to ADJUSTMENT in this section.
  - For damaged sealing surfaces, either replace glass lid weatherstrip, or repair the sealing panel.

#### ADJUSTMENT

#### CAUTION:

- Always work with a helper.
- Handle glass lid assembly with care to prevent damage.

#### NOTE:

A  
B  
C  
D  
E  
F  
G  
H  
I  
J

RF

L  
M  
N  
O  
P

# SUNROOF UNIT ASSEMBLY

< ON-VEHICLE REPAIR >

[WITH DUAL PANEL SUNROOF]

- For easier and more accurate installation, always mark each point before removal.
- After any adjustment, check sunroof operation and glass lid assembly alignment.

SEC. 736

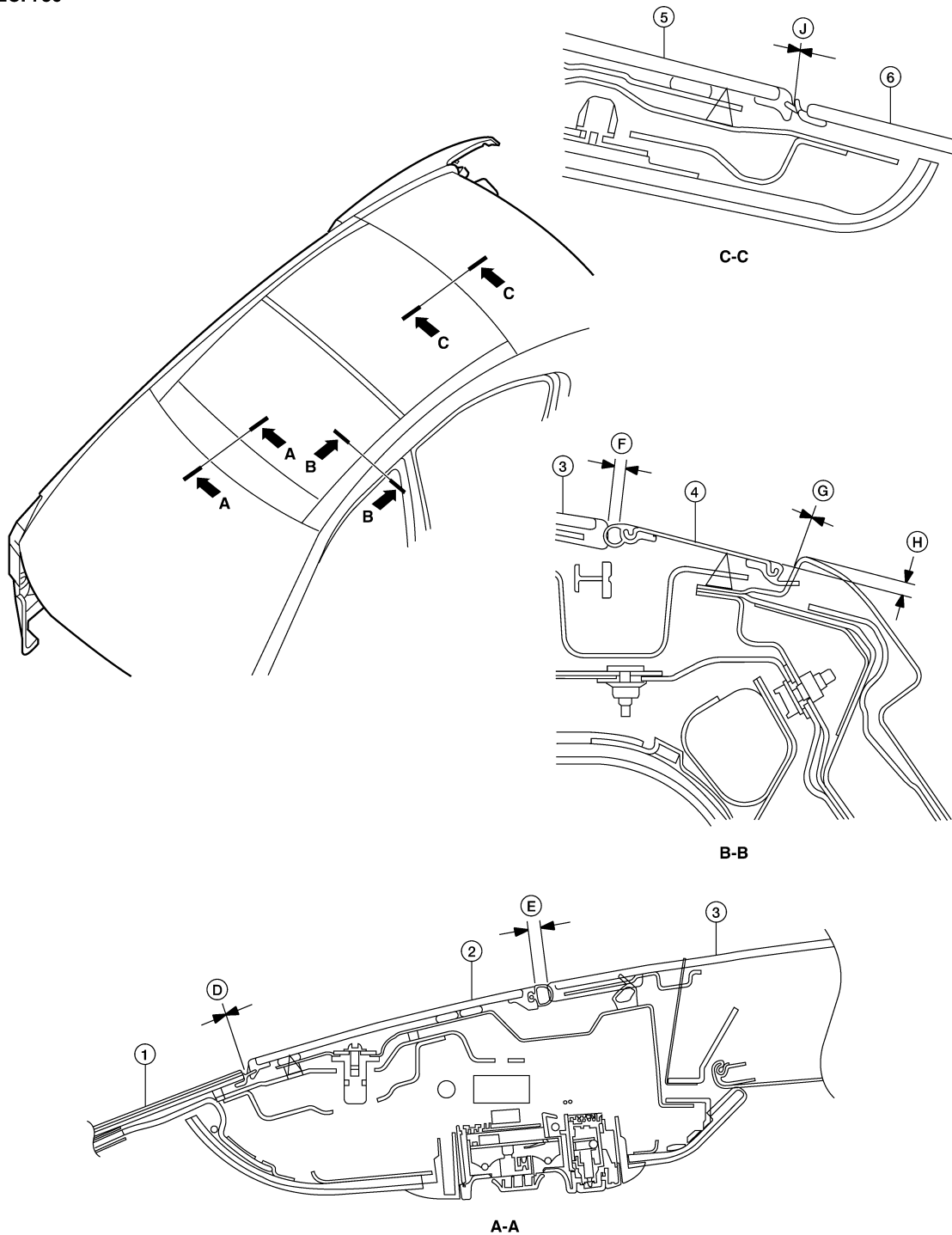

- |                       |  |   |
|-----------------------|--|---|
| 1. Windshield         | 2. Front sunroof glass                         | 3. Glass lid                            |
| 4. Roof side finisher | 5. Rear sunroof glass                          | 6. Rear window glass                    |
| D. 0.0 (No clearance) | E. $1.4 \pm 0.45$ ( $0.055 \pm 0.018$ )        | F. $1.4 \pm 0.45$ ( $0.055 \pm 0.018$ ) |
| G. 0.0 (No clearance) | H. $5.5 +2.5/ -1.5$ ( $0.217 +0.098/ -0.059$ ) | J. 0.0 (No clearance)                   |

AWKIA1549ZZ

Unit: mm (in)

# SUNROOF UNIT ASSEMBLY

< ON-VEHICLE REPAIR >

[WITH DUAL PANEL SUNROOF]

1. Open sunshade assembly.
2. Tilt glass lid up, then slide rearward to expose all the glass lid bolts.
3. Loosen glass lid bolts (4 each on left and right sides), then fully close glass lid.
4. Manually adjust glass lid from outside of vehicle so gaps A-A and B-B are within specifications.

**NOTE:**

Temporarily snug glass lid bolts to prevent movement between each adjustment.

5. Tilt glass lid up and down several times using sunroof switch to check that it operates smoothly.
6. Open glass lid up and tighten bolts to specification.

**NOTE:**

First tighten left front bolt, then right rear bolt on glass lid to prevent uneven torque while tightening remaining bolts.

7. Perform initialization procedure to make sure the closing operation is accurate and synchronized properly. Refer to [RF-88, "ADDITIONAL SERVICE WHEN REPLACING CONTROL UNIT : Special Repair Requirement"](#).
8. Perform water leak test.

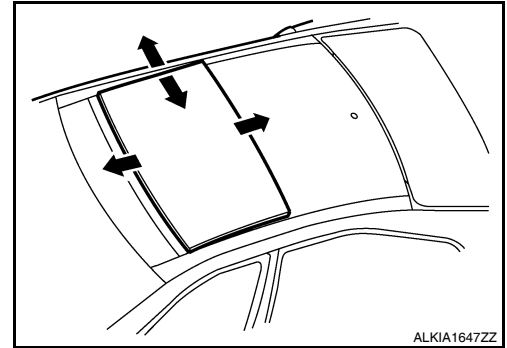

A  
B  
C  
D  
E  
F  
G  
H  
I  
J  
RF  
L  
M  
N  
O  
P

# SUNROOF UNIT ASSEMBLY

< ON-VEHICLE REPAIR >

[WITH DUAL PANEL SUNROOF]

## Exploded View

INFOID:000000005461900

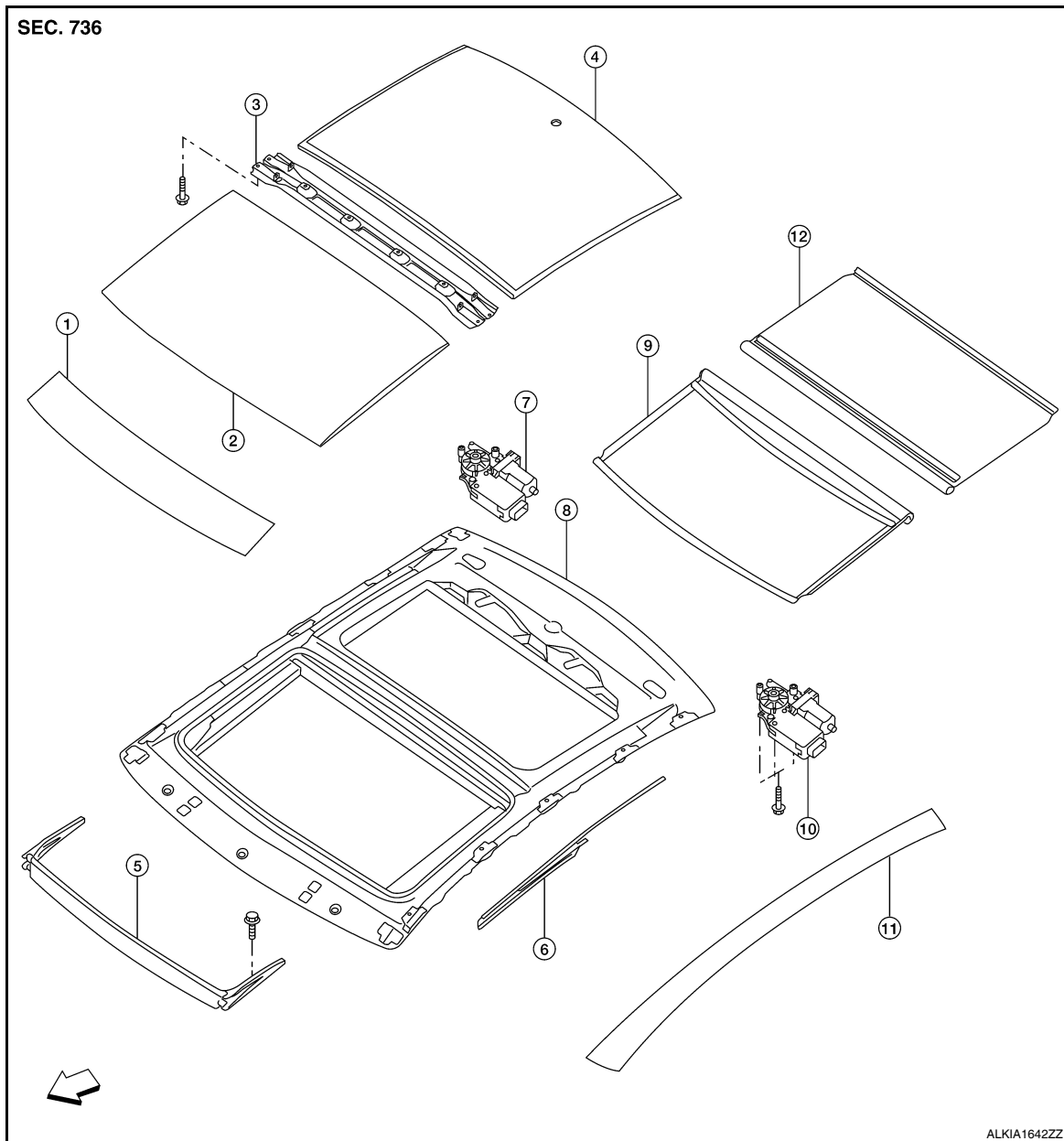

- |                            |                        |                              |
|----------------------------|------------------------|------------------------------|
| 1. Front sunroof glass     | 2. Glass lid           | 3. Sunshade carrier assembly |
| 4. Rear sunroof glass      | 5. Wind deflector      | 6. Inner blind               |
| 7. Sunshade motor assembly | 8. Sunroof frame       | 9. Front sunshade            |
| 10. Sunroof motor assembly | 11. Roof side finisher | 12. Rear sunshade            |
- ↶ Vehicle front

## Removal and Installation

INFOID:000000005461901

### REMOVAL

#### **WARNING:**

Disconnect the negative and positive battery terminals, then wait at least three minutes.

#### **CAUTION:**

- Always work with a helper.
- When taking sunroof unit assembly out, use cloths to protect the seats and trim from damage.
- Do not reuse the front or rear sunroof glass which has been removed once.

# SUNROOF UNIT ASSEMBLY

[WITH DUAL PANEL SUNROOF]

< ON-VEHICLE REPAIR >

1. Remove the headlining. Refer to [INT-32, "Removal and Installation"](#).
2. Remove the glass lid. Refer to [RF-174, "Removal and Installation"](#).
3. Remove the wind deflector. Refer to [RF-192, "Removal and Installation"](#).
4. Apply protective tape over the weather stripping seal.
5. Remove the sunshade carrier assembly. Refer to [RF-193, "Removal and Installation"](#).
6. Apply protective tape to the body surrounding the entire sunroof frame.
7. Remove the front sunroof glass. Refer to [RF-188, "Removal and Installation"](#).
8. Remove the roof side finishers. Refer to [RF-186, "Removal and Installation"](#).
9. Remove the rear window glass. Refer to [GW-14, "Removal and Installation"](#).
10. Remove the satellite antenna. Refer to [AV-336, "Removal and Installation"](#) Bose W/Color Display W/O NAVI, [AV-500, "Removal and Installation"](#) Bose W/Color Display W/NAVI, [AV-668, "Removal and Installation"](#) Bose W/Color W/RR CTL, [AV-837, "Removal and Installation"](#) Bose W/Color W/NAVI W/RR CTL.
11. Remove the rear sunroof glass. Refer to [RF-190, "Removal and Installation"](#).
12. Disconnect the sunroof motor assembly and sunshade motor assembly harness connectors.
13. Remove the front nuts (A), the rear nuts (B), and the rear bolts (C) from the dual panel sunroof.
14. Cut adhesive.
  - Pass piano wire through the adhesive with a wire pierce.
  - Tie piano wire on both ends to assist in wire grip.
  - Pull piano wire with sawing motion to cut through adhesive, working around entire circumference.
15. Using a helper, carefully lift each side and remove sunroof frame from vehicle.

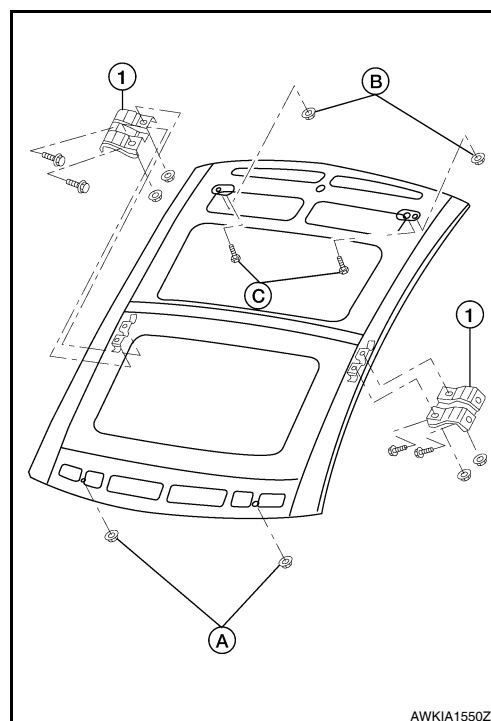

## INSTALLATION

### WARNING:

- Keep heat and open flames away as primers and adhesive are flammable.
- The materials contained in the kit are harmful if swallowed, and may irritate skin and eyes. Never let them contact the skin or eyes.
- Use in an open, well ventilated location. Never breathe the vapors. They may be harmful if inhaled. Move immediately to an area with fresh air if affected by vapor inhalation.

### CAUTION:

After installing the sunroof unit assembly and glass lid, perform the leak test and check that there is no air or water intrusion.

### NOTE:

- Use a genuine Nissan Urethane Adhesive Kit (if available) or an equivalent and follow the instructions furnished with it.
- Inform the customer that the vehicle should remain stationary until the urethane adhesive has completely cured (approximately 24 hours). Curing time varies with temperature and humidity.

# SUNROOF UNIT ASSEMBLY

< ON-VEHICLE REPAIR >

[WITH DUAL PANEL SUNROOF]

- Using a knife or spatula, trim the adhesive (sealant) remaining on body down to approximately 2 mm thick (a) so that the contour becomes smooth.

**CAUTION:**

**If bonded area on body is scratched, be sure to repair it with a 2-component urethane. Do not use lacquer.**

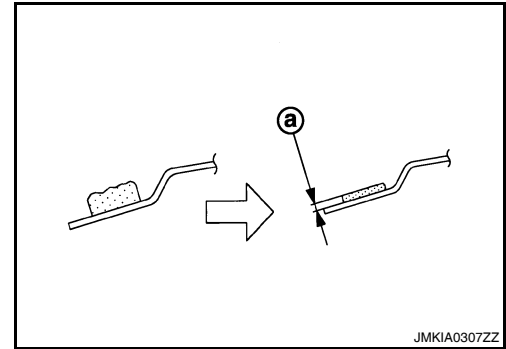

- When installing new sunroof unit assembly frame, mount the roof frame dry (no adhesive) first onto the vehicle and paint mating marks on body and sunroof frame, then remove sunroof frame again.
- Thoroughly clean bonding area on sunroof frame and body with isopropyl alcohol or equivalent.
- Apply primer to the body and the sunroof frame (lower) surfaces.

- Apply adhesive along the entire circumference of the sunroof unit assembly frame contact area of body within the time specified in the instructions for the adhesive.
  - Open adhesive by cutting off the nozzle tip and set it in a sealant gun.
  - Form a continuous bead of adhesive resembling the measurements in applied thickness (A), and in applied width (B) on the body panel.

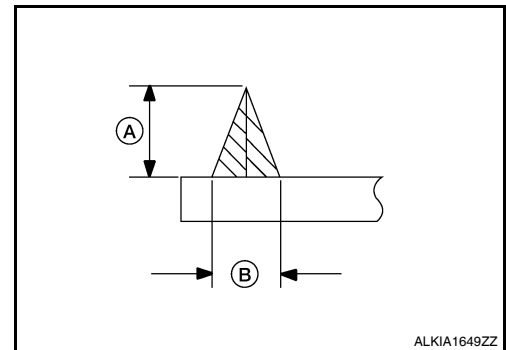

**Adhesive applied thickness (A) : 13 ± 1 mm (0.51 in ± 0.039 in)**

**Adhesive applied width (B) : 8 ± 1 mm (0.31 ± 0.039 in)**

- Using a helper, position the sunroof unit assembly frame over the body, visually aligning the paint mating marks. Then, lower the studs at each corner through the body panel holes, carefully installing the sunroof unit assembly to the body.
- Press down lightly by hand only on the frame to expand the adhesive contact completely so that it resembles a compressed thickness (A), and a compressed width (B) between the sunroof unit assembly frame and the body.

**Adhesive compressed thickness (A) : 5 +2/-1 mm (0.20 +0.079/-0.039 in)**

**Adhesive compressed width (B) : Front edge 15 mm (0.59 in)  
: Side edge 21 mm (0.83 in)  
: Rear edge 15 mm (0.59 in)**

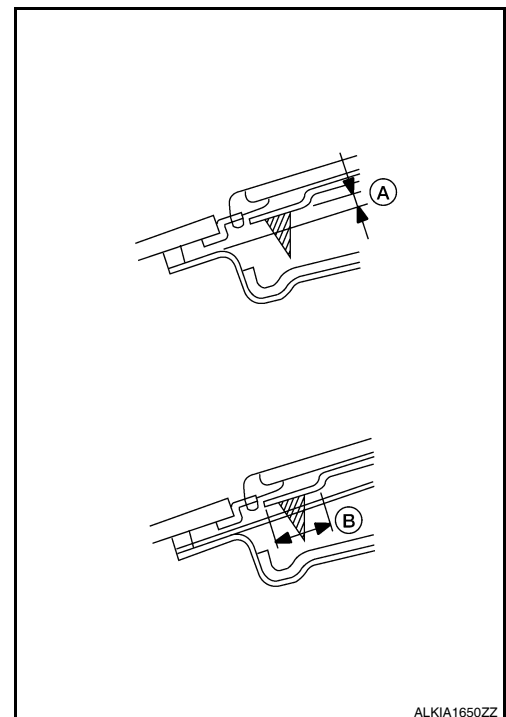



# SUNROOF UNIT ASSEMBLY

< ON-VEHICLE REPAIR >

[WITH DUAL PANEL SUNROOF]

8. Install and tighten the sunroof unit assembly nuts and bolts in the order shown within five minutes.

**Sunroof unit assembly nuts : 17 N·m (1.7kg-m, 13 ft-lb) and bolts**



**: Front**

9. Install the sunshade carrier assembly. Refer to [RF-193, "Removal and Installation"](#).
10. Using a suitable tool, remove any adhesive overflow, or work into pocket voids so as to make the surface edge smooth.
11. Install the rear sunroof glass. Refer to [RF-190, "Removal and Installation"](#).
12. Install the rear window glass. Refer to [GW-14, "Removal and Installation"](#).
13. Install the roof side finishers. Refer to [RF-186, "Removal and Installation"](#).
14. Install the front sunroof glass. Refer to [RF-188, "Removal and Installation"](#).
15. Connect the sunroof motor assembly and sunshade motor assembly harness connectors.
16. Install the wind deflector. Refer to [RF-192, "Removal and Installation"](#).
17. Install the glass lid. Refer to [RF-174, "Removal and Installation"](#).

**NOTE:**

After installation, carry out fitting adjustment. Refer to [RF-179, "Inspection and Adjustment"](#).

18. Install the satellite antenna. Refer to [AV-336, "Removal and Installation"](#) Bose W/Color Display W/O NAVI, or [AV-500, "Removal and Installation"](#) Bose W/Color Display W/NAVI, or [AV-668, "Removal and Installation"](#) Bose W/Color W/RR CTL, or [AV-837, "Removal and Installation"](#) Bose W/Color W/NAVI W/RR CTL.
19. Install the headlining. Refer to [INT-32, "Removal and Installation"](#).
20. Check for water leaks.

**NOTE:**

- Perform the water leakage check more than 2 hours after sunroof unit assembly installation.
- After glass lid fitting adjustment, carry out water leakage check by spreading water over entire roof surface.

21. Remove the protective tape from the vehicle.

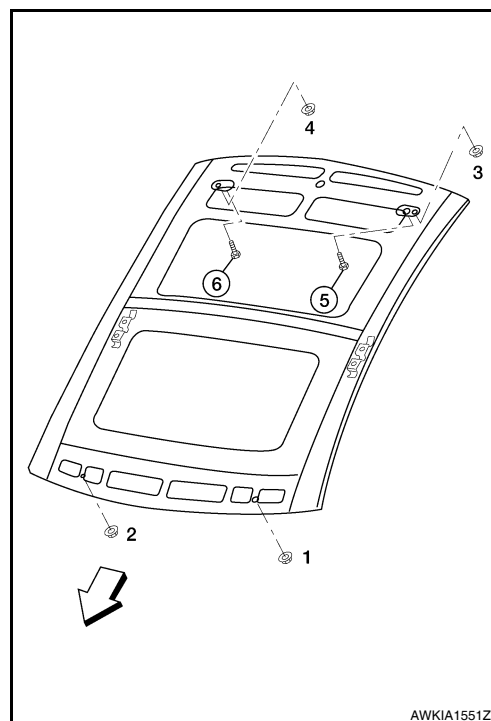

A  
B  
C  
D  
E  
F  
G  
H  
I  
J  
RF  
L  
M  
N  
O  
P

## ROOF FINISHER

### Removal and Installation

INFOID:000000005461902

#### REMOVAL

1. Open the glass lid.
2. Apply protective tape around the roof side finisher to protect the surface from damage.
3. Cut adhesive.
  - Pass piano wire through the adhesive with a wire pierce.
  - Tie piano wire on both ends to assist in wire grip.
  - Pull piano wire with sawing motion to cut through adhesive, working along the length of the panel.
4. Remove the roof side finisher.

#### INSTALLATION

##### WARNING:

- Keep heat and open flames away as primers and adhesive are flammable.
- The materials contained in the kit are harmful if swallowed, and may irritate skin and eyes. Never let them contact the skin or eyes.
- Use in an open, well ventilated location. Never breathe the vapors. They may be harmful if inhaled. Move immediately to an area with fresh air if affected by vapor inhalation.

##### NOTE:

- Use a genuine Nissan Urethane Adhesive Kit (if available) or an equivalent and follow the instructions furnished with it.
- Inform the customer that the vehicle should remain stationary until the urethane adhesive has completely cured (approximately 24 hours). Curing time varies with temperature and humidity.

1. Using a knife or spatula, trim the adhesive (sealant) remaining on body down to approximately 2 mm thick (a) so that the contour becomes smooth.

##### CAUTION:

If bonded area on body is scratched, be sure to repair it with a 2-component urethane. Do not use lacquer.

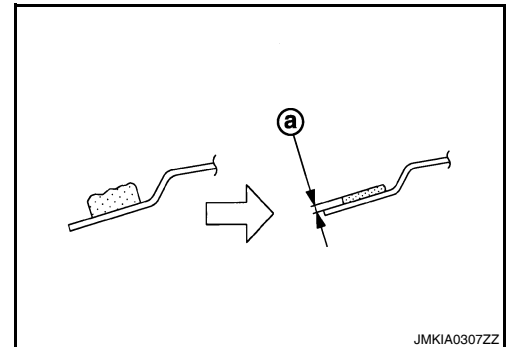

2. When installing new roof side finisher, position the roof side finisher dry (no adhesive) first onto the vehicle and paint mating marks on the body and roof side finisher, then remove it again.
3. Thoroughly clean bonding area on the roof side finisher and the body with isopropyl alcohol or equivalent.
4. Apply primer to the body and the roof side trim (lower) surfaces.
5. Apply adhesive to the contact areas of the body within the time specified in the instructions for the adhesive.
  - Open adhesive by cutting off the nozzle tip and set it in a sealant gun.
  - Form a continuous bead of adhesive resembling the measurements in applied thickness (A), and in applied width (B) on the body panel.

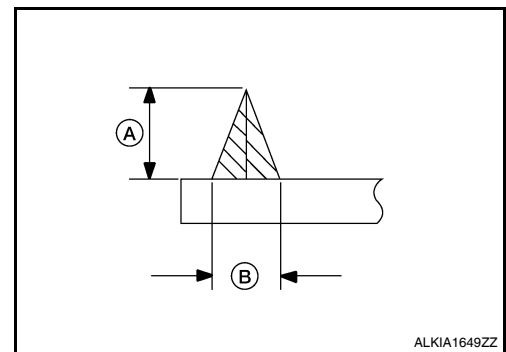

**Adhesive applied thickness (A) : 13 ± 1 mm (0.51 ± 0.039 in)**

**Adhesive applied width (B) : 8 ± 1 mm (0.31 ± 0.039 in)**

## ROOF FINISHER

< ON-VEHICLE REPAIR >

[WITH DUAL PANEL SUNROOF]

6. Position the roof side finisher, align the paint marks, then lower it into position.
7. Press down lightly by hand to evenly expand the adhesive contact with the roof side finisher.
8. Using a suitable tool, remove any adhesive overflow.
9. Remove the protective tape.

A

B

C

D

E

F

G

H

I

J

RF

L

M

N

O

P

# FRONT SUNROOF GLASS

< ON-VEHICLE REPAIR >

[WITH DUAL PANEL SUNROOF]

## FRONT SUNROOF GLASS

### Removal and Installation

INFOID:000000005461903

#### REMOVAL

1. Remove the wind deflector. Refer to [RF-192. "Removal and Installation"](#).
2. Tape down the glass lid weatherstrip along the front sunroof glass with protective tape.
3. Apply protective tape around the front sunroof glass to protect the surface from damage.
4. Cut adhesive.
  - Pass piano wire through the adhesive with a wire pierce.
  - Tie piano wire on both ends to assist in wire grip.
  - Pull piano wire with a sawing motion to cut through the adhesive.
5. Remove the front sunroof glass.

#### INSTALLATION

##### WARNING:

- Keep heat and open flames away as primers and adhesive are flammable.
- The materials contained in the kit are harmful if swallowed, and may irritate skin and eyes. Never let them contact the skin or eyes.
- Use in an open, well ventilated location. Never breathe the vapors. They may be harmful if inhaled. Move immediately to an area with fresh air if affected by vapor inhalation.

##### NOTE:

- Use a genuine Nissan Urethane Adhesive Kit (if available) or an equivalent and follow the instructions furnished with it.
- Inform the customer that the vehicle should remain stationary until the urethane adhesive has completely cured (approximately 24 hours). Curing time varies with temperature and humidity.

1. Using a knife or spatula, trim the adhesive (sealant) remaining on body down to approximately 2 mm thick (a) so that the contour becomes smooth.

##### CAUTION:

If bonded area on body is scratched, be sure to repair it with a 2-component urethane. Do not use lacquer.

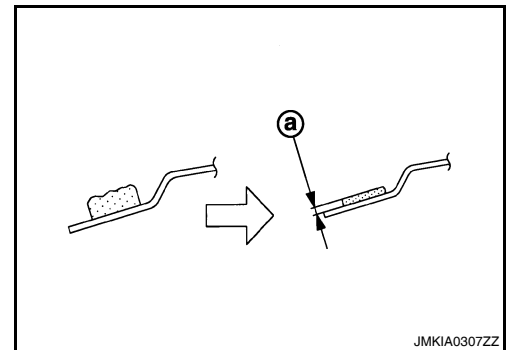

2. When installing new front sunroof glass, position the front sunroof glass (no adhesive) first onto the vehicle and paint mating marks on the body and the front sunroof glass, then remove it again.
3. Thoroughly clean bonding area on the front sunroof glass and the body with isopropyl alcohol or equivalent.
4. Apply primer to the body and the front sunroof glass (lower) surfaces.
5. Apply adhesive to the contact areas of the body within the time specified in the instructions for the adhesive.
  - Open adhesive by cutting off the nozzle tip and set it in a sealant gun.
  - Form a continuous bead of adhesive resembling the measurements in applied thickness (A), and in applied width (B) on the body panel.

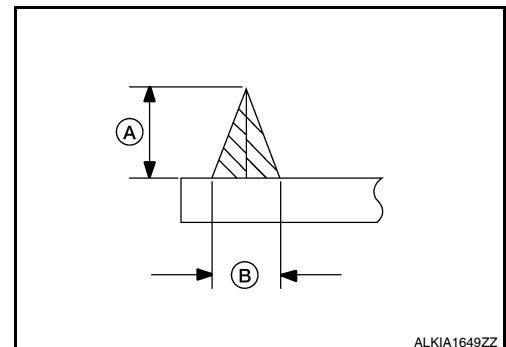

# FRONT SUNROOF GLASS

< ON-VEHICLE REPAIR >

[WITH DUAL PANEL SUNROOF]

**Adhesive applied thickness (A) :  $13 \pm 1$  mm ( $0.51 \pm 0.039$  in)**

**Adhesive applied width (B) :  $8 \pm 1$  mm ( $0.31 \pm 0.039$  in)**

6. Position the front sunroof glass, align the paint marks and lower it into position.
7. Press down lightly by hand to evenly expand the adhesive contact with the front sunroof glass.
8. Using a suitable tool, remove any adhesive overflow.
9. Remove the protective tape.

A

B

C

D

E

F

G

H

I

J

RF

L

M

N

O

P

# REAR SUNROOF GLASS

< ON-VEHICLE REPAIR >

[WITH DUAL PANEL SUNROOF]

## REAR SUNROOF GLASS

### Removal and Installation

INFOID:000000005461904

#### REMOVAL

1. Apply protective tape around all of the glass panels to be removed.
2. Remove the satellite radio antenna. Refer to [AV-336, "Removal and Installation"](#) Bose W/Color Display W/O Navi, or [AV-500, "Removal and Installation"](#) Bose W/Color Display W/Navi, or [AV-668, "Removal and Installation"](#) Bose W/Color W/RR CTL, or [AV-837, "Removal and Installation"](#) Bose W/Color W/Navi W/RR CTL.
3. Remove the rear window glass. Refer to [GW-14, "Removal and Installation"](#).
4. Remove the glass lid. Refer to [RF-174, "Removal and Installation"](#).
5. Remove the roof side finishers. Refer to [RF-186, "Removal and Installation"](#).
6. Cut adhesive.
  - Pass piano wire through the adhesive with a wire pierce.
  - Tie piano wire on both ends at assist in wire grip.
  - Pull piano wire with a sawing motion to cut through the adhesive.
7. Remove the rear sunroof glass.

#### INSTALLATION

##### **WARNING:**

- Keep heat and open flames away as primers and adhesive are flammable.
- The materials contained in the kit are harmful if swallowed, and may irritate skin and eyes. Never let them contact the skin or eyes.
- Use in an open, well ventilated location. Never breathe the vapors. They may be harmful if inhaled. Move immediately to an area with fresh air if affected by vapor inhalation.

##### **NOTE:**

- Use a genuine Nissan Urethane Adhesive Kit (if available) or an equivalent and follow the instructions furnished with it.
- Inform the customer that the vehicle should remain stationary until the urethane adhesive has completely cured (approximately 24 hours). Curing time varies with temperature and humidity.

1. Using a knife or spatula, trim the adhesive (sealant) remaining on body down to approximately 2 mm thick (a) so that the contour becomes smooth.

##### **CAUTION:**

If bonded area on body is scratched, be sure to repair it with a 2-component urethane. Do not use lacquer.

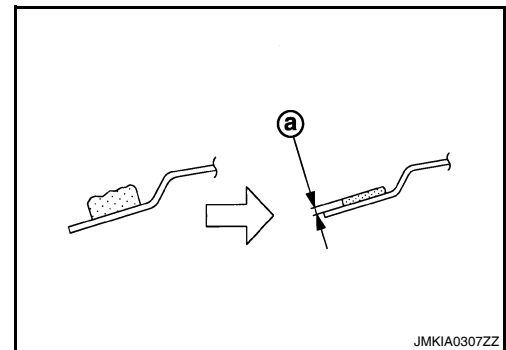

2. When installing new rear sunroof glass, position the rear sunroof glass (no adhesive) first onto the vehicle and paint mating marks on the body and the rear sunroof glass, then remove it again.
3. Thoroughly clean bonding area on the rear glass panel and the body with isopropyl alcohol or equivalent.
4. Apply primer to the sunroof frame anywhere the surface has been scratched and the rear sunroof glass (lower) surfaces.

## REAR SUNROOF GLASS

< ON-VEHICLE REPAIR >

[WITH DUAL PANEL SUNROOF]

5. Apply adhesive along the entire circumference of the rear sunroof glass frame contact area of the body within the time specified in the instructions for the adhesive. Also apply adhesive around the satellite antenna hole outward from the hole along the sunroof frame.
  - Open adhesive by cutting off the nozzle tip and set it in a sealant gun.
  - Form a continuous bead of adhesive resembling the measurements in applied thickness (A), and in applied width (B) on the sunroof frame.

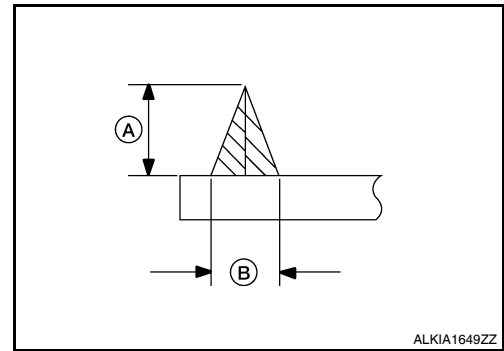

**Adhesive applied thickness (A) :  $13 \pm 1$  mm ( $0.51 \pm 0.039$  in)**

**Adhesive applied width (B) :  $8 \pm 1$  mm ( $0.31 \pm 0.039$  in)**

6. Position the rear sunroof glass, align the paint marks and lower it into position.
7. Press down lightly by hand to evenly expand the adhesive contact with the rear sunroof glass. Press down by hand to expand the adhesive contact completely so that it resembles a compressed thickness (A), and a compressed width (B).

**Adhesive compressed thickness (A) :  $5 +2, -1$ mm ( $0.20 +0.079 - 0.039$  in)**

**Adhesive compressed width (B)**  
: Front edge 15 mm (0.59 in)  
: Side edge 21 mm (0.83 in)  
: Rear edge 15 mm (0.59 in)

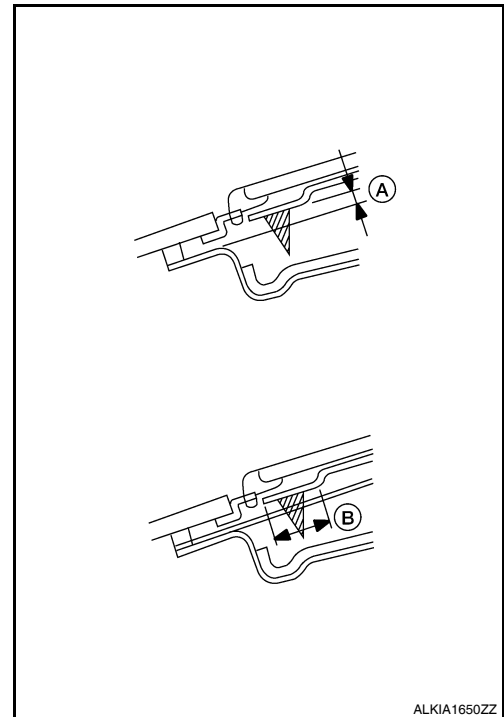

8. Install the rear window glass. Refer to [GW-14, "Removal and Installation"](#).
9. Install the roof side finishers. Refer to [RF-186, "Removal and Installation"](#).
10. Install the glass lid. Refer to [RF-174, "Removal and Installation"](#).  
**NOTE:**  
After installation, carry out fitting adjustment. Refer to [RF-179, "Inspection and Adjustment"](#).
11. Install the satellite radio antenna. Refer to [AV-336, "Removal and Installation"](#) Bose W/Color Display W/O Navi, or [AV-500, "Removal and Installation"](#) Bose W/Color Display W/Navi, or [AV-668, "Removal and Installation"](#) Bose W/Color W/RR CTL, or [AV-837, "Removal and Installation"](#) Bose W/Color W/Navi W/RR CTL.
12. Check for water leaks.  
**NOTE:**
  - Perform the water leakage check more than 2 hours after sunroof unit assembly installation.
  - After glass lid fitting adjustment, carry out water leakage check by spreading water over entire roof surface.
13. Remove the protective tape from the vehicle.

# WIND DEFLECTOR

[WITH DUAL PANEL SUNROOF]

< ON-VEHICLE REPAIR >

## WIND DEFLECTOR

### Removal and Installation

INFOID:000000005461905

#### REMOVAL

1. Open the glass lid.
2. Remove the side screw (A) to release the wind deflector side arms (1).

⇐ : Front

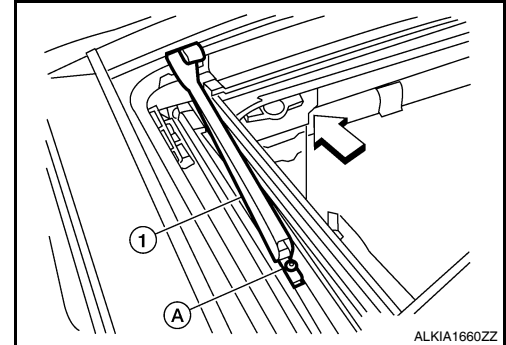

3. Disconnect and release the inner blind (1) slide clip from wind deflector.

⇐ : Front

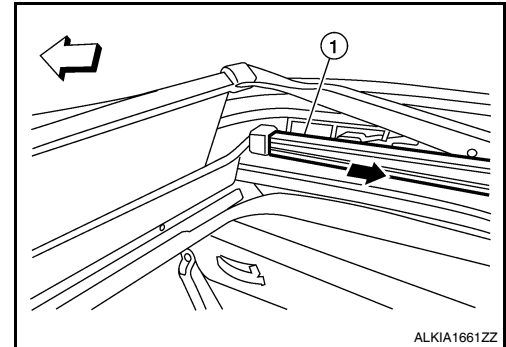

4. Remove the front screws (A), then remove wind deflector from sunroof unit assembly.

⇐ : Front

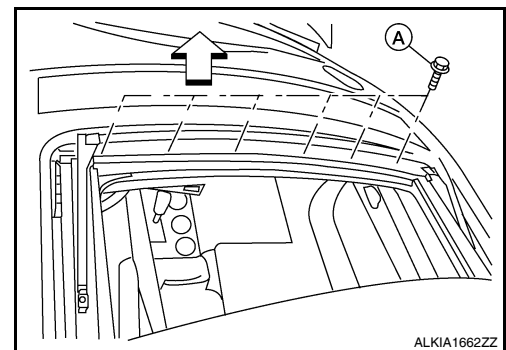

#### INSTALLATION

Installation is in the reverse order of removal.



# SUNSHADE

< ON-VEHICLE REPAIR >

[WITH DUAL PANEL SUNROOF]

## SUNSHADE

### Exploded View

INFOID:000000005461906

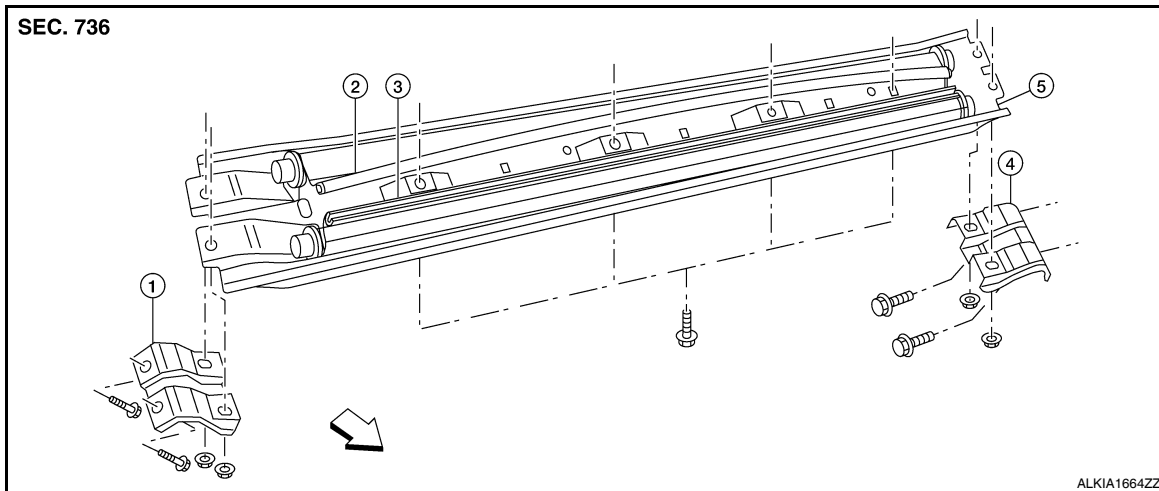

- |                      |                              |                   |
|----------------------|------------------------------|-------------------|
| 1. Center bracket RH | 2. Rear sunshade             | 3. Front sunshade |
| 4. Center bracket LH | 5. Sunshade carrier assembly | ← Vehicle front   |

### Removal and Installation

INFOID:000000005461907

#### REMOVAL

1. Open glass lid and sunshades.
2. Remove the headlining. Refer to [INT-32, "Removal and Installation"](#).
3. Release front sunshade rail (1) from sunshade drive post (2).

← : Front

4. Repeat sunshade drive post release for the rear sunshade.
5. Remove side curtain air bag module bolts (two on each RH/LH sides) for access.
6. Release harness clips from sunshade carrier assembly.
7. Remove the center bracket nuts and bolts, then remove the center brackets (RH/LH).
8. Remove the sunshade carrier assembly bolts, then lower sunshade assembly and remove from vehicle.
  - Release the end key slot from the sunshades.

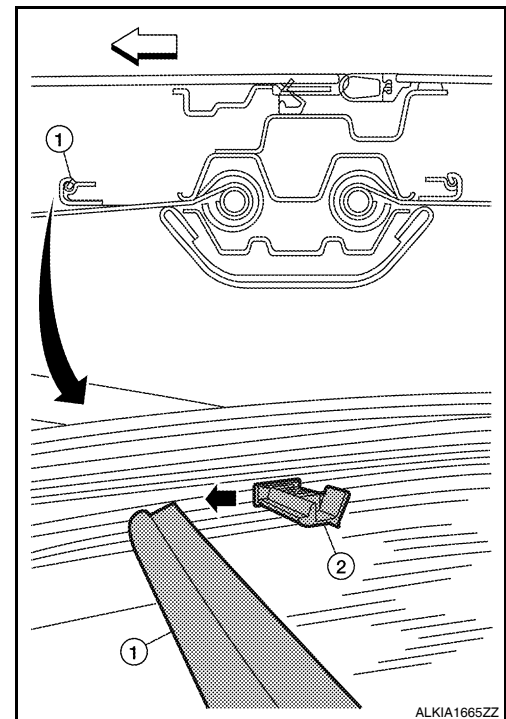

#### INSTALLATION

##### CAUTION:

**Be careful not to release the spring when installing the sunshade.**

1. Wind the shade around the core post.
2. Insert the round end of the shade (front - black curved rail) into the sunshade carrier assembly.

## SUNSHADE

< ON-VEHICLE REPAIR >

[WITH DUAL PANEL SUNROOF]

3. Using a suitable tool, wind the double-D tang end 20 turns counter-clockwise (when viewed from the end).
4. Insert the double-d tang end into the slot and lock it into the carrier.
5. Position the sunshade carrier assembly and install the bolts.
6. Position the center brackets (RH/LH) and install the bolts and nuts.
7. Install the side curtain air bag module bolts.
8. Install the headliner. Refer to [INT-32. "Removal and Installation"](#).

# SUNROOF SWITCH

< ON-VEHICLE REPAIR >

[WITH DUAL PANEL SUNROOF]

## SUNROOF SWITCH

### Removal and Installation

INFOID:000000005461908

The sunroof switch (1) is an integrated part of the front room/map lamp (2), and therefore serviced as an assembly. For front room/map lamp removal and installation procedures, refer to [INL-97](#), "[Removal and Installation](#)".

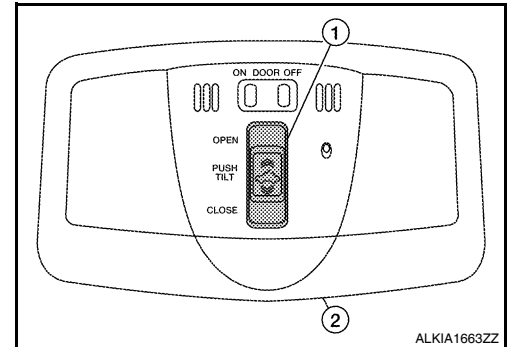

A  
B  
C  
D  
E  
F  
G  
H  
I  
J  
RF  
L  
M  
N  
O  
P